

THIS DOCUMENT IS THE PROPERTY OF
KEYSTONE ELECTRONICS CORP. AND
SHALL NOT BE REPRODUCED, DISTRIBUTED
OR USED AS A BASIS FOR MANUFACTURE
WITHOUT PRIOR WRITTEN PERMISSION
FROM KEYSTONE ELECTRONICS CORP.

MOUNTING DETAIL

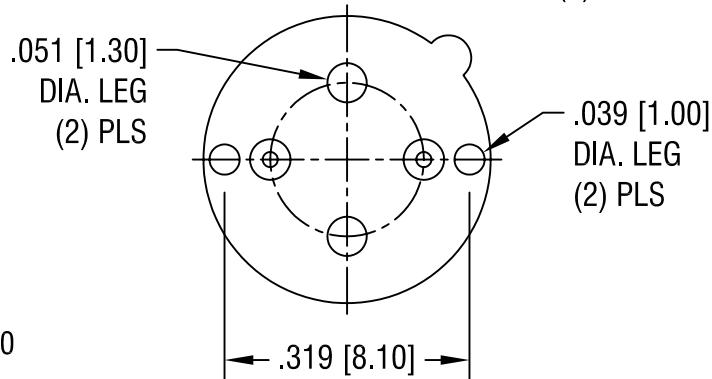
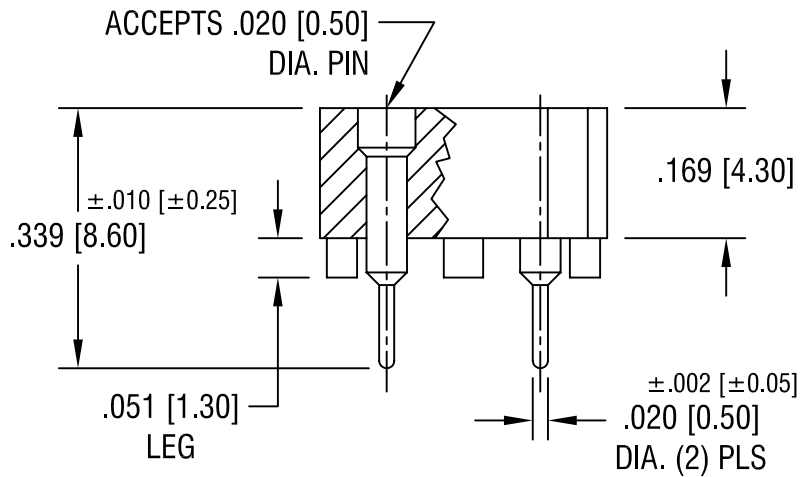
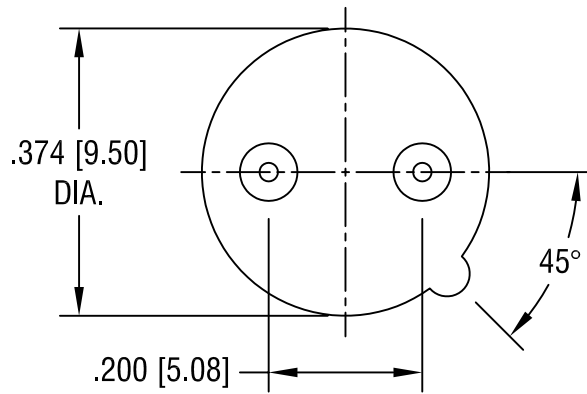
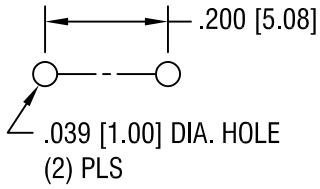

NOTES:

- 1. INSULATOR:
MAT'L - THERMOPLASTIC, UL94 V-0
- CONTACT PIN:
MAT'L - BRASS
FINISH - TIN PLATE
- CONTACT SPRING:
MAT'L - BERYLLIUM COPPER
FINISH - GOLD PLATE

KEYSTONE ELECTRONICS CORP.

ASTORIA, N.Y. 11105-2017

PART NAME		SUBMINIATURE FUSE HOLDER	
MATERIAL			
AS NOTED			
FINISH		DRN BY	DATE
AS NOTED		BOONE	6.20.06
		APP'D	SCALE
			4X
TOLERANCES	INCH [MM]	CODE	DWG NO.
DECIMAL	±.005 [±0.15]	C/M	3556
ANGULAR	± 1°		
UNLESS OTHERWISE SPECIFIED			

DATE	DESCRIPTION	REV.

X-ON Electronics

Largest Supplier of Electrical and Electronic Components

Click to view similar products for [Fuse Holder](#) category:

Click to view products by [Keystone](#) manufacturer:

Other Similar products are found below :

[570-290-741P40](#) [570-290-751P40](#) [020417G](#) [020418E](#) [6R30A1B](#) [F600A3B](#) [80910030](#) [8601.2020](#) [G15A2SPQ](#) [9-3557-GP REV A](#) [HDJ-B](#)
[R6J30A3S](#) [HFH-1](#) [RF30A2B](#) [RF30A3SP](#) [15600-08-10](#) [BK/FHN19G](#) [BK/HHM](#) [BK/HKP-CCHH](#) [BK/HKP-JJ](#) [BK/HTJ-LES-FUSE](#) [HMG-](#)
[241](#) [HTJ-LES-FUSE](#) [C4044-1](#) [2086-1](#) [2193](#) [2602](#) [2650](#) [178.000100](#) [FHN31G1](#) [T30A2B](#) [G4PB8](#) [2660](#) [2799](#) [CQ-209V](#) [HKP-CCHH](#)
[R6F30A2S](#) [341001A](#) [345621A](#) [CVRMCC](#) [4202](#) [4407](#) [4408](#) [4413](#) [4423](#) [4532](#) [4537](#) [TSD1404-12](#) [BK/FHN31G1](#) [BK/HC-5](#)