

THIS DOCUMENT IS THE PROPERTY OF KEYSTONE ELECTRONICS CORP. AND SHALL NOT BE REPRODUCED, DISTRIBUTED OR USED AS A BASIS FOR MANUFACTURE WITHOUT PRIOR WRITTEN PERMISSION FROM KEYSTONE ELECTRONICS CORP.

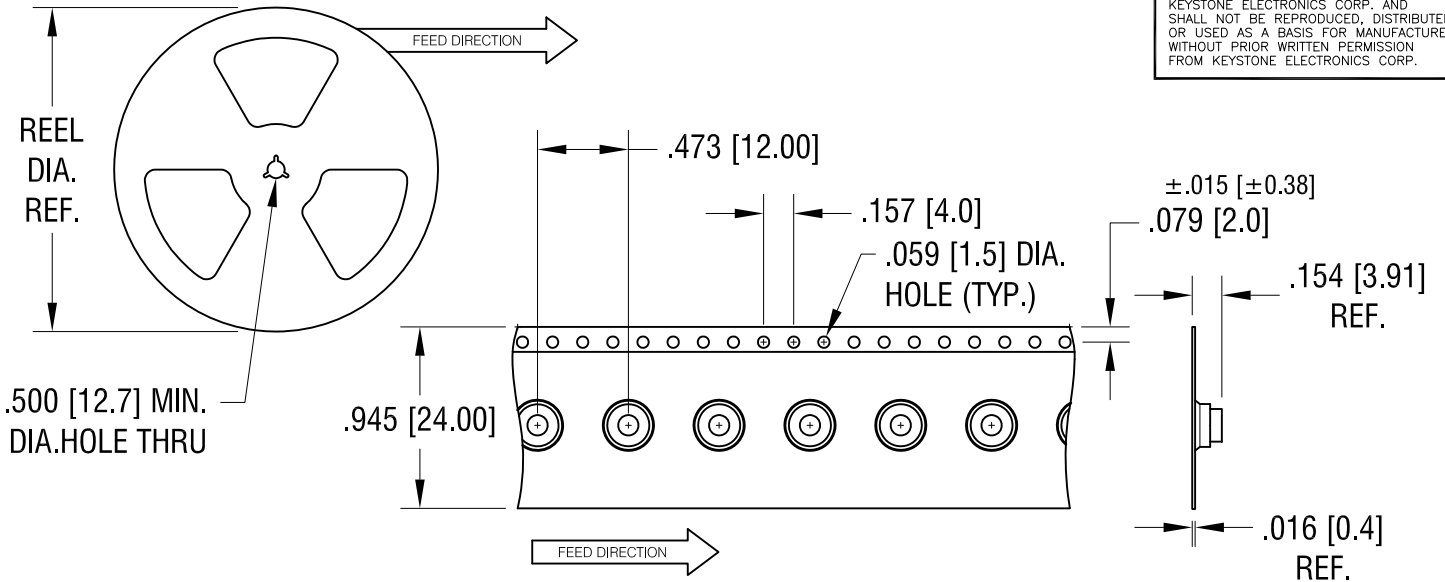

**MOUNTING DETAIL**

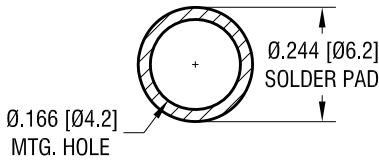

**ACTUAL SIZE**

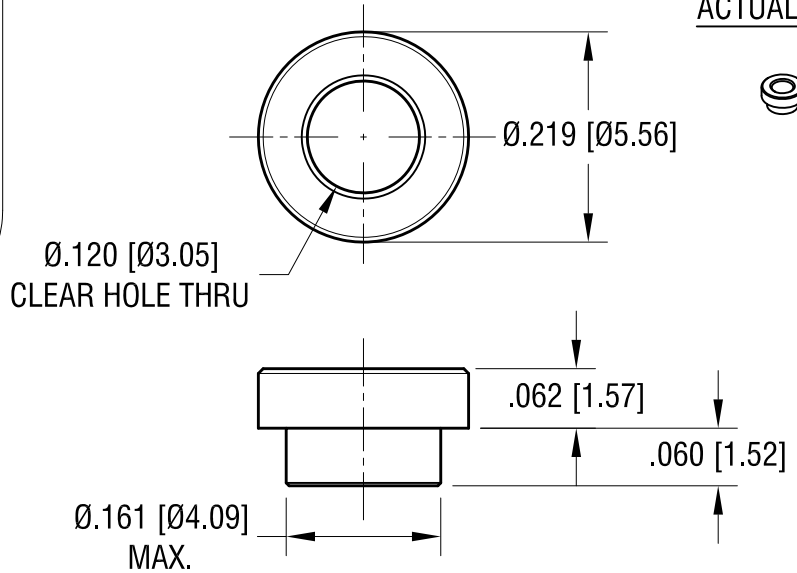

**NOTES:**

1. SUPPLIED ON TAPE AND REEL ONLY.  
TAPE AND REEL SPECIFICATIONS:
2. TAPE:  
MAT'L - ALL CONDUCTIVE POLYSTYRENE CARRIER  
ANSI/EIA-481 STANDARD
3. REEL:  
13" [330.2] DIA. 1500 PIECES PER REEL
4. KAPTON TAPE ADDED TO TOP SURFACE  
OF STANDOFF

<b>KEYSTONE ELECTRONICS CORP.</b>			
www.keyelco.com • NEW HYDE PARK, NY 11040 • Tel (516) 328-7500			
PART NAME		SM STANDOFF	
MATERIAL		STEEL	
FINISH	DRN BY	DATE	
ELECTRO-TIN	NT	1.03.17	
	APP'D	SCALE	
		5X, 1X	
TOLERANCES	INCH	[MM]	CODE
DECIMAL	± .005	[± 0.13]	C
ANGULAR	± 1°		DWG NO.
UNLESS OTHERWISE SPECIFIED			<b>4886</b>

DATE	DESCRIPTION	REV.	
------	-------------	------	--

## X-ON Electronics

Largest Supplier of Electrical and Electronic Components

*Click to view similar products for [Standoffs & Spacers](#) category:*

*Click to view products by [Keystone](#) manufacturer:*

Other Similar products are found below :

[588-6208-02](#) [599-9844-02](#) [M0516-3-N](#) [M0518-3-N](#) [M0521-3-N](#) [M0524-3-N](#) [M0532-35-N](#) [M0543-4-AL](#) [M0544-35-N](#) [M0544-3-N](#) [M0545-3-AL](#) [M0553-3-N](#) [M0608-5-SS](#) [M0609-5-SS](#) [M0651-5-SS](#) [M0653-35-N](#) [M0654-4-SS](#) [M0655-5-AL](#) [M0658-35-AL](#) [M0660-4-AL](#) [M0670-35-N](#) [M0671-5-N](#) [M0671-5-SS](#) [M0722-5-N](#) [M0725-6-N](#) [M0904-B-25-AL](#) [M1273-2545-AL](#) [M1273-2545-SS](#) [M1273-3005-AL](#) [M1273-3005-SS](#) [M1274-3005-AL](#) [60187](#) [60202-SP](#) [60273](#) [60348-SP](#) [60419-SP](#) [60425-SP](#) [60473-SP](#) [60475-SP](#) [60477-SP](#) [60489-SP](#) [60491-SP](#) [60585-SP](#) [60762-SP](#) [60763-SP](#) [60872-SP](#) [M1303-3506-AL](#) [M1307-3506-AL](#) [M1314-3005-AL](#) [M1314-3005-SS](#)