

THIS DOCUMENT IS THE PROPERTY OF
KEYSTONE ELECTRONICS CORP. AND
SHALL NOT BE REPRODUCED, DISTRIBUTED
OR USED AS A BASIS FOR MANUFACTURE
WITHOUT PRIOR WRITTEN PERMISSION
FROM KEYSTONE ELECTRONICS CORP.

ACTUAL SIZE

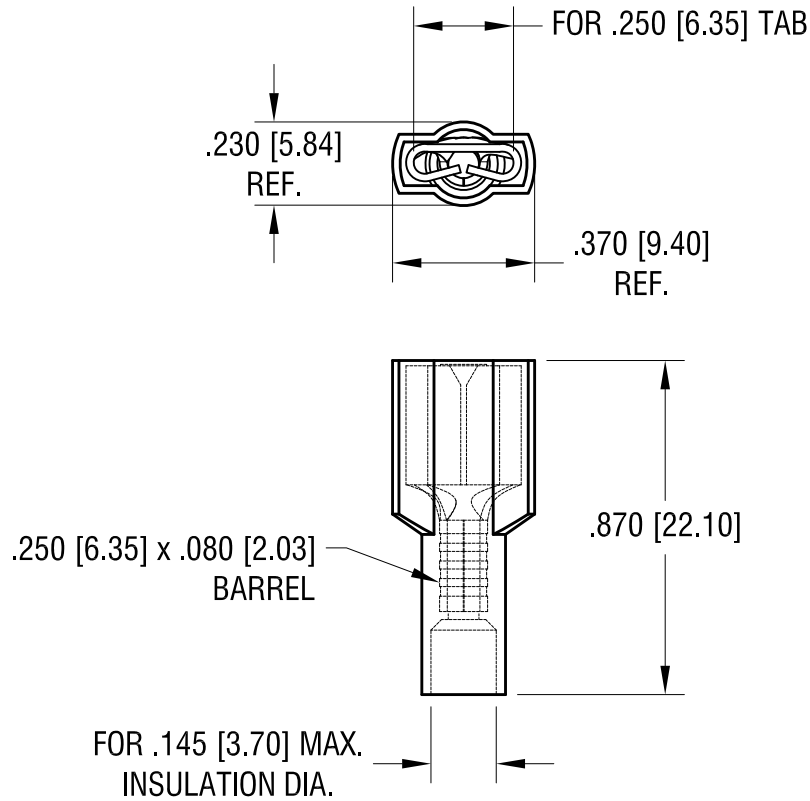
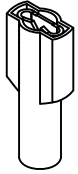

NOTE:

1. TERMINAL: MATES WITH MALE TAB
.250 [6.35] x .032 [0.81] TH'K
MATERIAL: BRASS, TIN PLATE
INSULATOR: NYLON 6/6, RED
2. ACCOMMODATES WIRE RANGE 22/18 AWG

8.04.21	TERMINAL MAT'L WAS COPPER CHANGE AS PER ECN21-078	B
12.29.14	CHANGE AS PER ECN 14-129	A
DATE	DESCRIPTION	REV.

KEYSTONE ELECTRONICS CORP.			
www.keyelco.com • NEW HYDE PARK, NY 11040 • Tel (516) 328-7500			
PART NAME			
FULLY INSULATED QUICK-FIT TERMINAL			
MATERIAL			
AS NOTED			
FINISH		DRN BY	DATE
AS NOTED		NT	6.09.09
		APP'D	SCALE
			2X
TOLERANCES	INCH [MM]	CODE	DWG NO.
DECIMAL	± .015 [± 0.38]	C	8292
ANGULAR	± 1°		
UNLESS OTHERWISE SPECIFIED			

X-ON Electronics

Largest Supplier of Electrical and Electronic Components

Click to view similar products for [Terminals](#) category:

Click to view products by [Keystone](#) manufacturer:

Other Similar products are found below :

[00-054007-01074-6](#) [00-054007-70206-1](#) [00-054007-70210-8](#) [00-054007-70217-7](#) [00-054007-70226-9](#) [00-054007-70228-3](#) [00-054007-70248-1](#) [00-054007-70256-6](#) [00-054007-70301-3](#) [00-054007-70316-7](#) [00-054007-49560-4](#) [00-054007-70209-2](#) [00-054007-70225-2](#) [00-054007-70227-6](#) [00-054007-70231-3](#) [00-054007-70241-2](#) [00-054007-70242-9](#) [00-054007-70244-3](#) [00-054007-70246-7](#) [00-054007-70263-4](#) [00-054007-70288-7](#) [00-054007-70290-0](#) [00-054007-70300-6](#) [00-054007-70304-4](#) [01-2065-1-0216](#) [01-2900-1-04412](#) [00581P0075](#) [600TS-10](#) [60205-1](#) [604200-1](#) [605601-1](#) [60598-1-CUT-TAPE](#) [61314-6-C](#) [61810-3](#) [61-S](#) [62149-1](#) [626-0194](#) [62-NBM-A](#) [62-SN](#) [62-SP](#) [640179-1](#) [M55155/059I03](#) [M55155/079C01](#) [M55155/099H02](#) [M55155/109H01](#) [M55155/109H02](#) [M55155/12XH05](#) [M55155/16XH02](#) [M55155/29-5S](#) [M55155/29XJ08](#)