

THIS DOCUMENT IS THE PROPERTY OF
KEYSTONE ELECTRONICS CORP. AND
SHALL NOT BE REPRODUCED, DISTRIBUTED
OR USED AS A BASIS FOR MANUFACTURE
WITHOUT PRIOR WRITTEN PERMISSION
FROM KEYSTONE ELECTRONICS CORP.

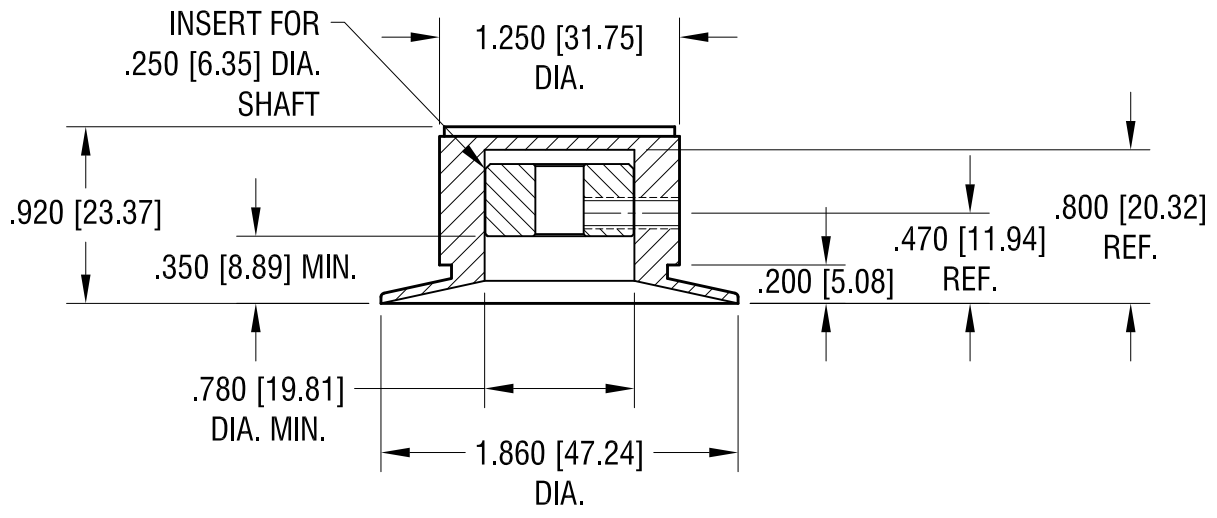
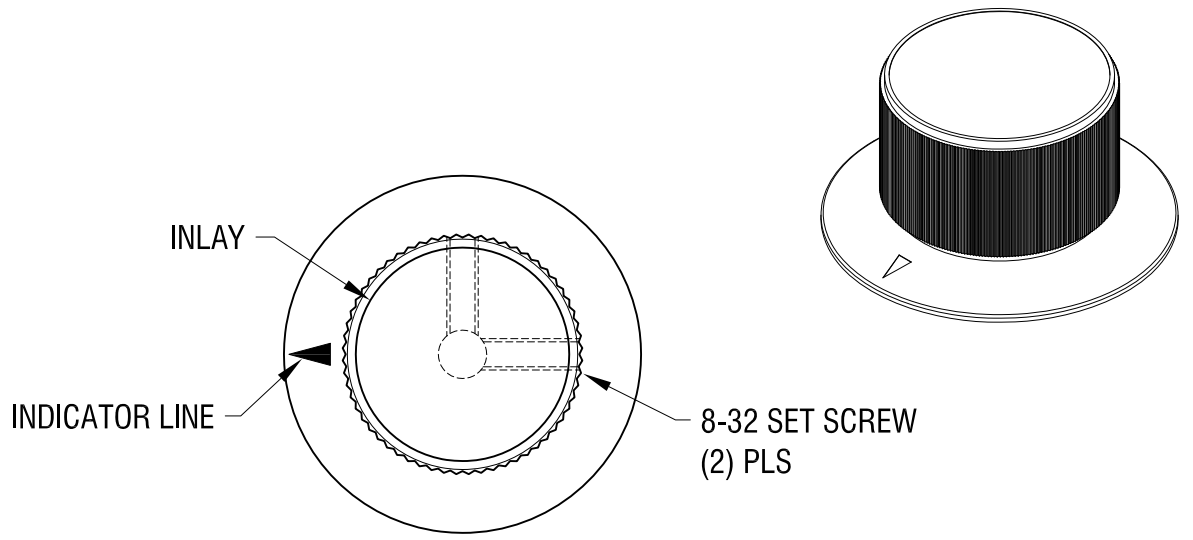

NOTES:

1. KNOB: MAT'L: ABS, BLACK
2. INSERT: MAT'L: BRASS, NICKEL PLATE
3. INLAY: MAT'L: SPUN ALUMINUM
4. SCREW: MAT'L- STEEL
FINISH- BLACK OXIDE

KEYSTONE ELECTRONICS CORP.			
www.keyelco.com • ASTORIA, N.Y. 11105-2017 • Tel (718) 956-8900			
PART NAME		KNOB	
MATERIAL		AS NOTED	
FINISH		DRN BY	DATE
AS NOTED		BOONE	1.8.07
		APP'D	SCALE
			1X
TOLERANCES	INCH [MM]	CODE	DWG NO.
DECIMAL	± .015 [± 0.38]	C	8561
ANGULAR	± 1°		
UNLESS OTHERWISE SPECIFIED			

DATE	DESCRIPTION	REV.	
------	-------------	------	--

X-ON Electronics

Largest Supplier of Electrical and Electronic Components

Click to view similar products for [Knobs & Dials](#) category:

Click to view products by [Keystone](#) manufacturer:

Other Similar products are found below :

[8519](#) [8529](#) [8547](#) [8573](#) [11K5015-EMNB](#) [11K5019-ECNB](#) [11K5020-KLAB](#) [11K5048-KMNB](#) [11K5014-EMNB](#) [11K5015-EMNG](#) [11K5019-EMNB](#) [1770](#) [P400S-08-D6-N](#) [K6510](#) [PKJ50B18](#) [42000B38](#) [420114B14](#) [5006](#) [KS700B14](#) [411](#) [420037B14](#) [52-928.60](#) [8517](#) [8545](#) [8546](#) [8572](#) [H-516-3A](#) [P861H-0X-S6](#) [8544](#) [11K5014-JMNG](#) [11K5014-KMNG](#) [11K5014-ECNG](#) [5700E](#) [5002-5](#) [52-928.40](#) [5003-5](#) [11K5019-KCNG](#) [11K5028-KCNG](#) [02000-11A-2](#) [02000-4-1](#) [0025DF](#) [G813512LADUS-0](#) [2810-Y](#) [3009CC](#) [3025BA](#) [YME IP 12 D](#) [YME IP 01 A](#) [YME IP 12 H](#) [YME IP 12L-U](#) [YME IP 16 I](#)