

FRONT SHELL

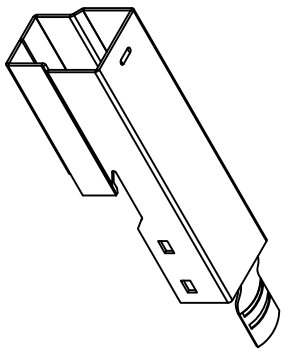

INSERTED BODY

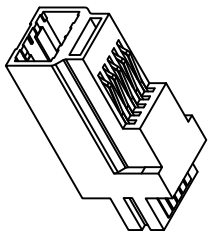

REAR SHELL

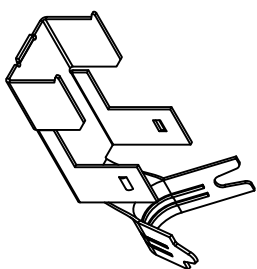

ASSEMBLED PLUG

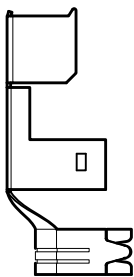
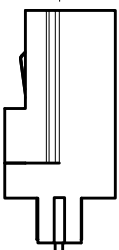
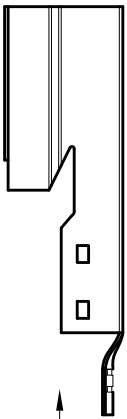
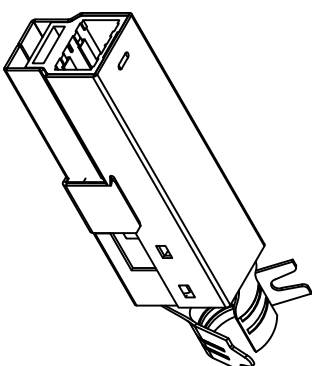

$\pm .032$ [± 0.81]

1.417 [36.00]

.411 [10.44]

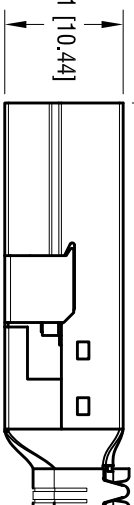

.315 [8.00]

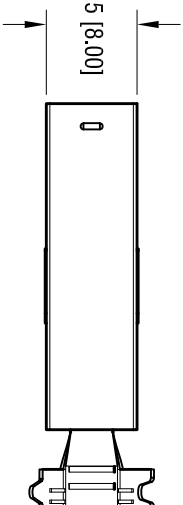

PLUG SPECIFICATIONS:

- SHELL: MAT'L- STEEL
- FINISH- NICKEL PLATE
- INSULATION: MAT'L- THERMOPLASTIC, UL 94V-0
- CONTACT: MAT'L- PHOSPHOR BRONZE
- FINISH- GOLD FLASH OVER NICKEL

ELECTRICAL CHARACTERISTICS:

- RATED VOLTAGE: 30V (RMS)
- CONTACT CURRENT RATING: 1 Amp DC MAX.
- CONTACT RESISTANCE: 15m Ω min.
- DIELECTRIC WITHSTANDING VOLTAGE: 750V AC FOR 1 MINUTE
- MECHANICAL CHARACTERISTICS:
- OPERATING TEMPERATURE: -13 $^{\circ}$ F (-25 $^{\circ}$ C) TO 176 $^{\circ}$ F (+80 $^{\circ}$ C)
- DURABILITY: 1500 CYCLES MIN.

DATE	DESCRIPTION	REV.
5.23.16	CHANGE AS PER ECN 16-060	A
	UPDATE HOUSING	

KEYSTONE ELECTRONICS CORP.
 www.keystone.com • NEW HYDE PARK, NY 11040 • Tel (516) 328-7500

PART NAME
 USB 3.0 TYPE B PLUG KIT

MATERIAL
 AS NOTED

FINISH
 AS NOTED

TOLERANCES	INCH	[MM]	CODE	DWG NO.
DECIMAL	$\pm .010$	[± 0.25]	C	952
ANGULAR	$\pm 1^{\circ}$			

THIS DOCUMENT IS THE PROPERTY OF KEYSTONE ELECTRONICS CORP. AND SHALL NOT BE REPRODUCED, DISTRIBUTED OR USED AS A BASIS FOR MANUFACTURE WITHOUT PRIOR WRITTEN PERMISSION FROM KEYSTONE ELECTRONICS CORP.

DRN BY: NT
 DATE: 4.07.10
 App'D: SCALE: 2X

X-ON Electronics

Largest Supplier of Electrical and Electronic Components

Click to view similar products for [USB Connectors](#) category:

Click to view products by [Keystone](#) manufacturer:

Other Similar products are found below :

[65-647-8-BK-BU](#) [950](#) [E8144-B01021-L](#) [A-USB A-LP-SMT-C](#) [A-USB B-TOP-C](#) [MUSBA511N5](#) [MUSBD11135](#) [217450-1](#) [CA 6 W LD](#)
[KMBVX-TH-5S-B30](#) [896-30-004-00-000000](#) [KUSBVX-BS1N-W30](#) [KUSBX-AP-KIT-SCBLK](#) [KUSBX-AS2N-W](#) [KUSBX-SMT2AP1S-W](#)
[KUSBX-SMT2AP1S-W30](#) [935](#) [957](#) [30-498-6](#) [17-210051](#) [1734082-1](#) [30-1574](#) [30-470](#) [30-489](#) [30-541](#) [30-572-3](#) [MAB 8 SN V](#) [A-USB A-](#)
[2P-C](#) [MIKROE-1451](#) [USBFTV2PEM2G](#) [USBFTVC6ZN](#) [KUSBX-AS2N-W30](#) [KUSBX-SLAS1N-W](#) [KUSBX-SMT-AS1N-W30](#) [4689-1](#) [1-](#)
[1734084-2](#) [E8110-001-01](#) [MUSBA81130](#) [33UBARS1-04SW11](#) [33UBAR-04SW11](#) [USBF21ZNSCC](#) [USBBFTV6ZC](#) [10135326-001LF](#)
[M9177/3-1](#) [USB-A-S-F-B-VT](#) [925](#) [4198](#) [690-024-633-031](#) [KUSBEX-BSFS1N-W](#) [USBFTVC6MRG](#)