

1. Description

KCX3406A is an N-channel enhancement mode power MOS field effect transistor which is produced using KIA's LVMOS technology. The improved process and cell structure have been especially tailored to minimize on-state resistance, provide superior switching performance.

This device is widely used in Secondary synchronous rectifier, Power Management for Inverter Systems.

2. Features

- n 80A,60V, $R_{DS(ON)(typ.)}=8.5m\Omega @ V_{GS}=10V$
- n SGT MOSFET
- n Low Gate Charge
- n Low Crss
- n Fast switching
- n Improved dv/dt capability

3. Pin configuration



Pin	Function
1,2,3	Source
4	Gate
5,6,7,8	Drain

4. Ordering Information

Part Number	Package	Brand
KCY3406A	DFN5*6	KIA

5. Absolute maximum ratings

TC=25°C unless otherwise specified

Parameter	Symbol	Ratings	Unit	
Drain-to-Source Voltage	V_{DSS}	60	V	
Gate-to-Source Voltage	V_{GSS}	±20	V	
Continuous Drain Current	I_D	$T_C=25^\circ\text{C}$	80	A
		$T_C=100^\circ\text{C}$	48	A
Pulsed Drain Current at $V_{GS}=10\text{V}$	I_{DM}	240	A	
Power Dissipation ($T_C=25^\circ\text{C}$)	P_D	63	W	
Derating Factor above 25°C		0.5	W/°C	
Single Pulsed Avalanche Energy(Note 1)	EAS	81	mJ	
Operation Junction Temperature Range	T_J	-55 to 150	°C	
Storage Temperature Range	T_{STG}	-55 to 150	°C	

6. Thermal characteristics

Parameter	Symbol	Ratings	Unit
Thermal Resistance, Junction-to-Case	$R_{\theta JC}$	2.0	°C/W
Thermal Resistance, Junction-to-Ambient	$R_{\theta JA}$	62	°C/W

7. Electrical characteristics

(T_J=25°C, unless otherwise notes)

Parameter	Symbol	Conditions	Min	Typ	Max	Units
Drain-to-Source Breakdown Voltage	BV _{DSS}	V _{GS} =0V, I _D =250uA	60	--	--	V
Drain-to-Source Leakage Current	I _{DSS}	V _{DS} =60V, V _{GS} =0V	--	--	1	uA
Gate-to-Source Leakage Current	I _{GSS}	V _{GS} =±20V, V _{DS} =0V	--	--	±100	nA
Gate Threshold Voltage	V _{GS(TH)}	V _{DS} =V _{GS} , I _D =250uA	1.0	2.0	3.0	V
Static Drain-to-Source On-Resistance	R _{DS(ON)}	V _{GS} =10V, I _D =13.5A	--	8.5	9.5	mΩ
		V _{GS} =4.5V, I _D =11.5A	--	13	15	mΩ
Gate Resistance	R _G	F=1MHz	--	1.8	--	Ω
Input Capacitance	C _{iss}	F=1.0MHz, V _{GS} =0V, V _{DS} =30V	--	1065	--	pF
Output Capacitance	C _{oss}		--	430	--	pF
Reverse Transfer Capacitance	C _{rss}		--	22	--	pF
Turn-on Delay Time	t _{d(ON)}	V _{DD} =30V, V _{GS} =10V, R _G =3Ω, I _D =13.5A (Note2,3)	--	8	--	nS
Rise Time	t _{rise}		--	54	--	nS
Turn-Off Delay Time	t _{d(OFF)}		--	19	--	nS
Fall Time	t _{fall}		--	8.8	--	nS
Total Gate Charge	Q _g	V _{DD} =48V, V _{GS} =10V, I _D =13.5A (Note2,3)	--	16.8	--	nC
Gate-to-Source Charge	Q _{gs}		--	5.9	--	nC
Gate-to-Drain (Miller) Charge	Q _{gd}		--	2.7	--	nC
Continuous Source Current ^[2]	I _{SD}	Integral Reverse P-N Junction Diode in the MOSFET	--	--	80	A
Pulsed Source Current ^[2]	I _{SM}		--	--	240	A
Diode Forward Voltage	V _{SD}	I _S =13.5A, V _{GS} =0V	--	--	1.4	V
Reverse Recovery Time	t _{rr}	I _S =13.5A, V _{GS} =0V, dI _F /dt=100A/us (Note2)	--	52	--	ns
Reverse Recovery Charge	Q _{rr}		--	0.05	--	nC

Notes:

- 1.L=0.5mH, V_{DD}=50V, R_G=10Ω, starting T_J=25°C ;
- 2.Pulse Test : Pulse width≤300us, Duty cycle≤2% ;
- 3.Essentially independent of operating temperature.

8. Typical Characteristics

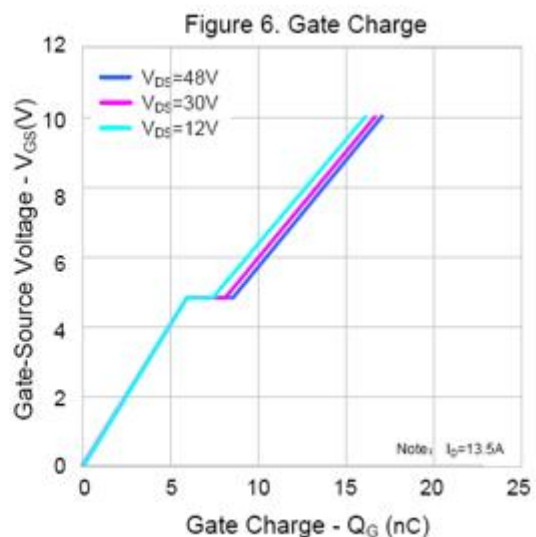
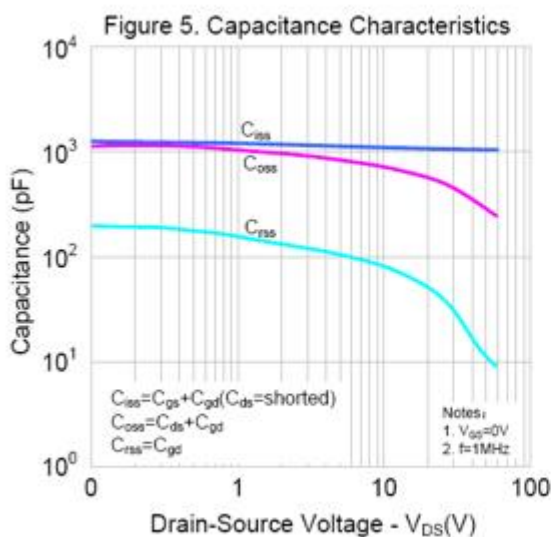
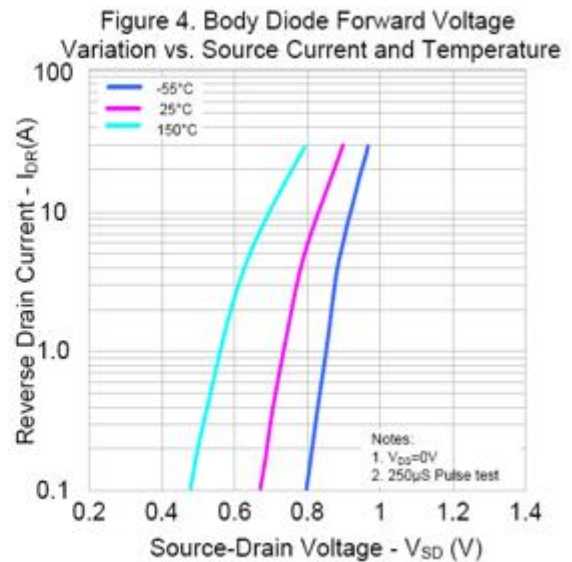
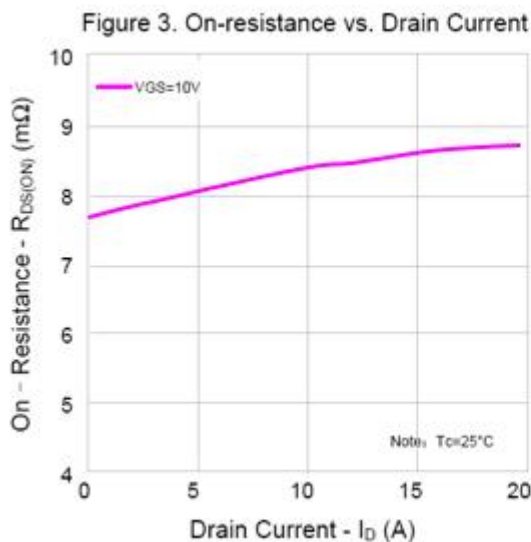
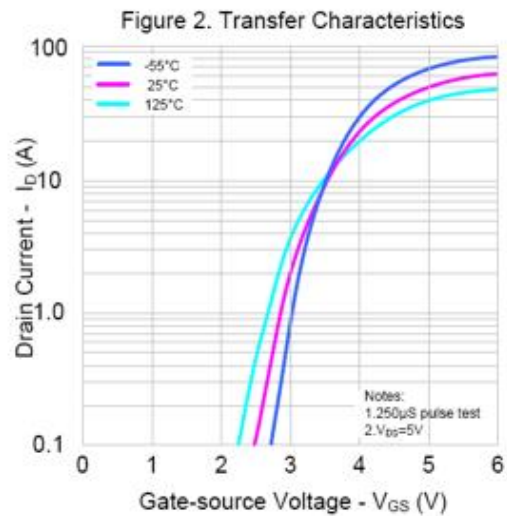
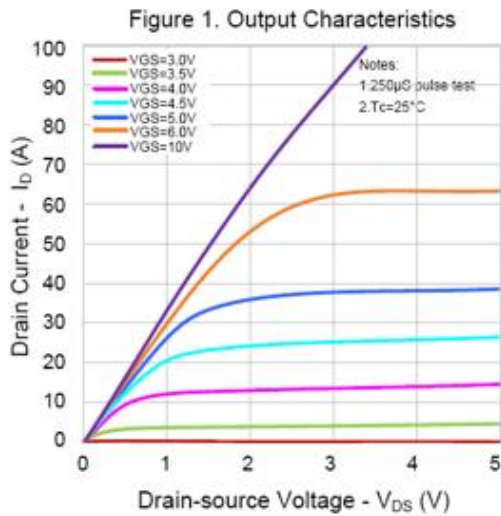

Figure 7. Breakdown Voltage vs. Temperature Characteristics

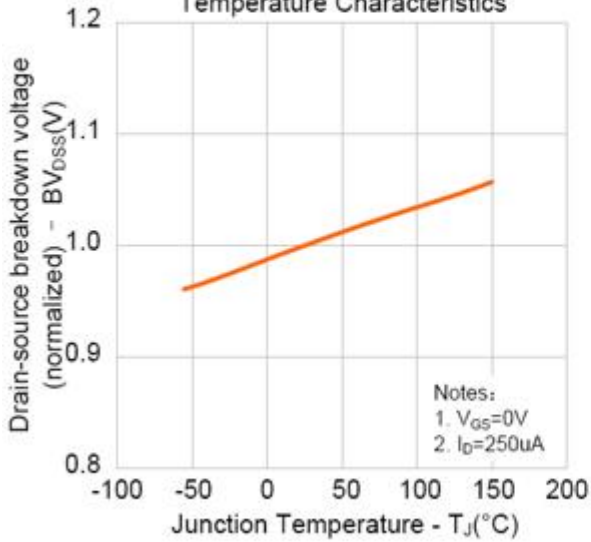

Figure 8. On-resistance vs. Temperature Characteristics

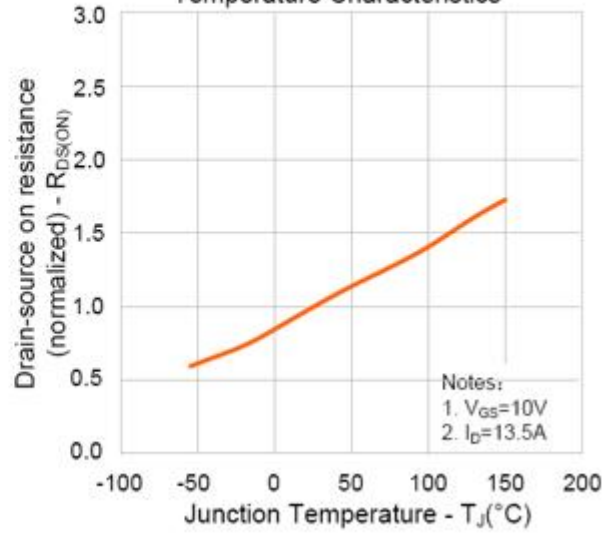
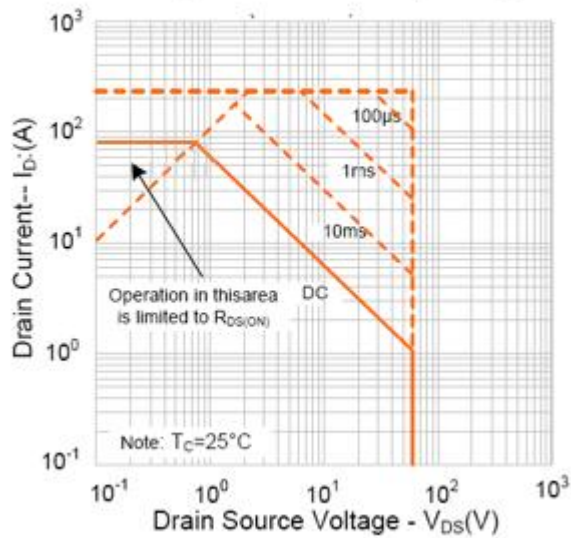
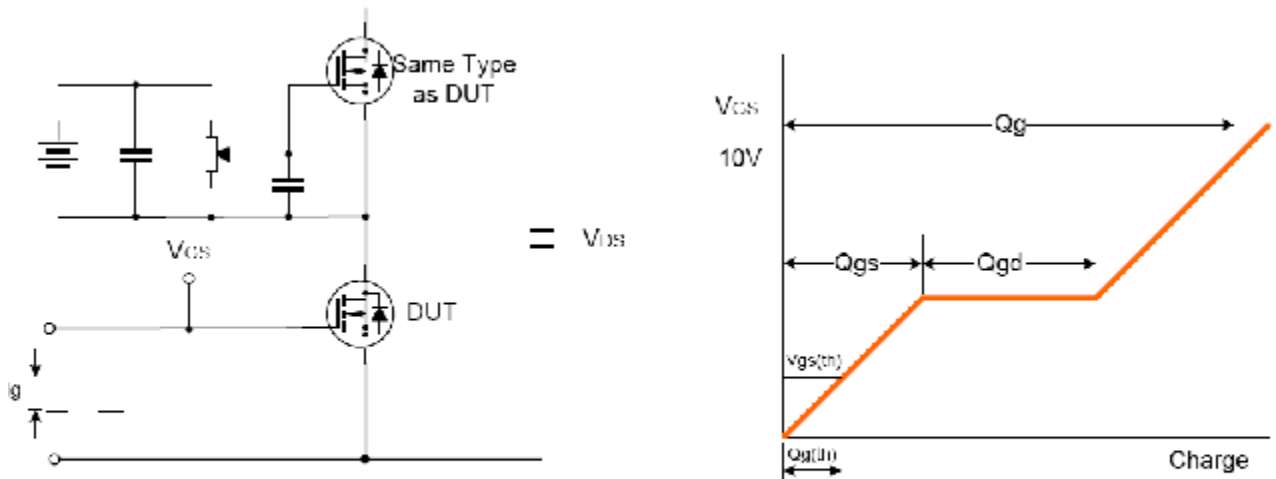

Figure 9. Max. Safe Operating



9. Test Circuits and Waveforms

Gate Charge Test Circuit & Waveform



Resistive Switching Test Circuit & Waveform

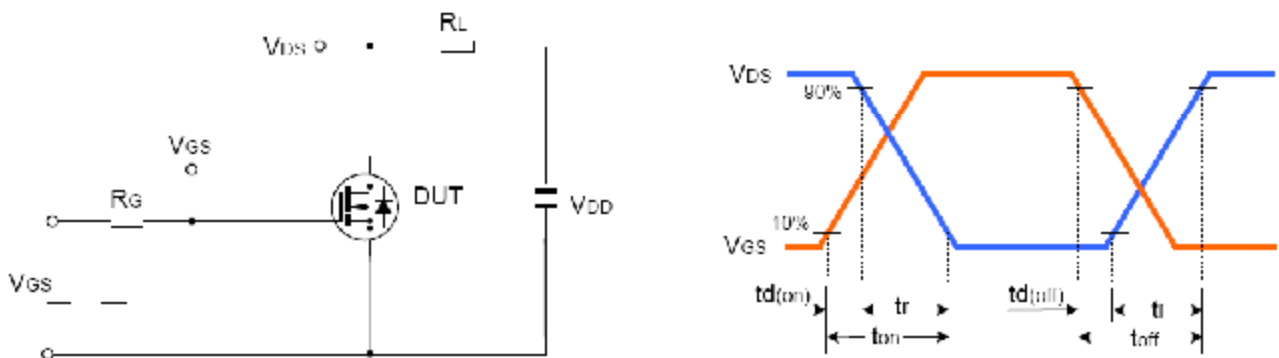

Unclamped Inductive Switching Test Circuit & Waveform

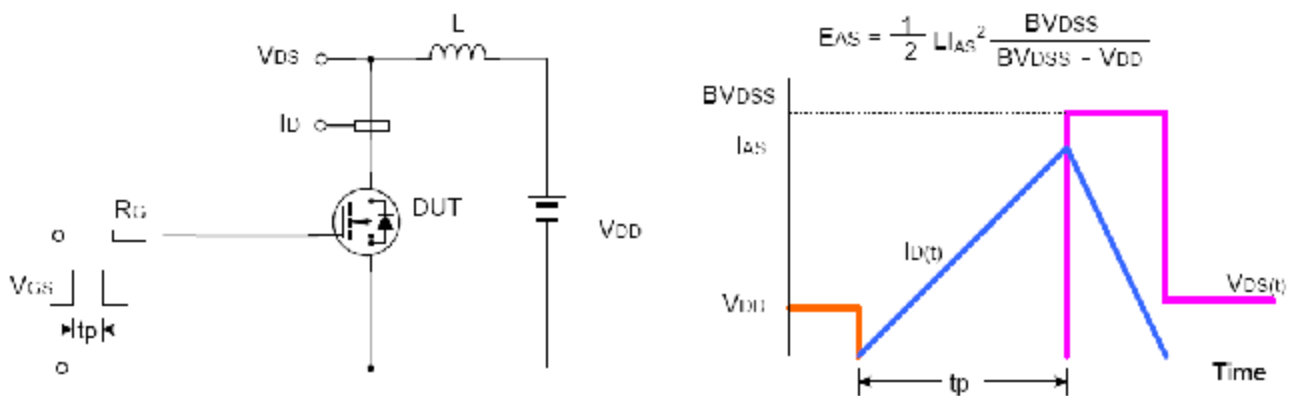

X-ON Electronics

Largest Supplier of Electrical and Electronic Components

Click to view similar products for [MOSFET](#) category:

Click to view products by [KIA](#) manufacturer:

Other Similar products are found below :

[614233C](#) [648584F](#) [MCH3443-TL-E](#) [MCH6422-TL-E](#) [NTNS3A92PZT5G](#) [IRFD120](#) [IRFF430](#) [JANTX2N5237](#) [2N7000](#) [AOD464](#)
[2SK2267\(Q\)](#) [2SK2545\(Q,T\)](#) [405094E](#) [423220D](#) [MIC4420CM-TR](#) [VN1206L](#) [614234A](#) [715780A](#) [SSM6J414TU,LF\(T](#) [751625C](#)
[IPS70R2K0CEAKMA1](#) [BSF024N03LT3 G](#) [PSMN4R2-30MLD](#) [TK31J60W5,S1VQ\(O](#) [2SK2614\(TE16L1,Q\)](#) [DMN1017UCP3-7](#)
[EFC2J004NUZTDG](#) [FCAB21350L1](#) [P85W28HP2F-7071](#) [DMN1053UCP4-7](#) [NTE2384](#) [NTE2969](#) [NTE6400A](#) [DMC2700UDMQ-7](#)
[DMN2080UCB4-7](#) [DMN61D9UWQ-13](#) [US6M2GTR](#) [DMN31D5UDJ-7](#) [SSM6P54TU,LF](#) [DMP22D4UFO-7B](#) [IPS60R3K4CEAKMA1](#)
[DMN1006UCA6-7](#) [DMN16M9UCA6-7](#) [STF5N65M6](#) [IRF40H233XTMA1](#) [IPSA70R950CEAKMA1](#) [IPSA70R2K0CEAKMA1](#) [STU5N65M6](#)
[C3M0021120D](#) [DMN6022SSD-13](#)