

1. General Features

- n Proprietary New Trench Technology
- n $R_{DS(ON),typ.}=4.0m\Omega@V_{GS}=10V$
- n Low Gate Charge Minimize Switching Loss
- n Fast Recovery Body Diode

2. Applications

- n High efficiency DC/DC converters
- n Synchronous Rectification
- n UPS Inverter

3. Pin configuration

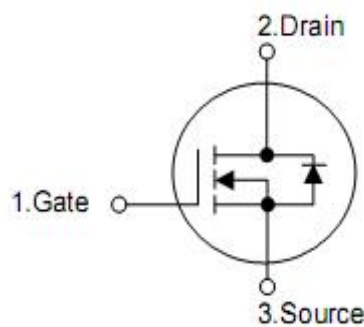
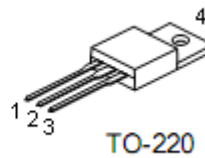
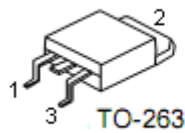

Pin	Function
1	Gate
2	Drain
3	Source
4	Drain

4. Ordering Information

Part Number	Package	Brand
KNP2708A	TO-220	KIA
KNB2708A	TO-263	KIA

5. Absolute maximum ratings

(T_C= 25 °C , unless otherwise specified)

Symbol	Parameter	Rating	Unit
V _{DSS}	Drain-to-Source Voltage ^[1]	80	V
V _{GSS}	Gate-to-Source Voltage	±20	
I _D	Continuous Drain Current ^[2]	160	A
	Continuous Drain Current ^[3]	80	
I _D @ T _C =100°C	Continuous Drain Current@T _C =100 °C ^[2]	116	
I _{DM}	Pulsed Drain Current at V _{GS} =10V ^[2,4]	640	
E _{AS}	Single Pulse Avalanche Energy	1100	mJ
dv /dt	Peak Diode Recovery dv/dt ^[3]	5.0	V/ns
P _D	Power Dissipation	313	W
	Derating Factor above 25 °C	2.08	W/ °C
T _L T _{PAK}	Maximum Temperature for Soldering Leads at 0.063in (1.6mm) from Case for 10 seconds, Package Body for 10 seconds	300 260	°C
T _J &T _{STG}	Operating and Storage Temperature Range	-55 to 175	

Caution: Stresses greater than those listed in the “Absolute Maximum Ratings” may cause permanent damage to the device.

6. Thermal characteristics

Symbol	Parameter	Rating	Unit
R _{θJC}	Thermal Resistance, Junction-to-Case	0.48	°C /W
R _{θJA}	Thermal Resistance, Junction-to-Ambient	62	

7. Electrical characteristics

OFF Characteristics		(T _J =25°C, unless otherwise specified)				
Symbol	Parameter	Test Conditions	Min.	Typ.	Max.	Unit
BV _{DSS}	Drain-to-Source Breakdown Voltage	V _{GS} =0V, I _D =250uA	80	--	--	V
I _{DSS}	Drain-to-Source Leakage Current	V _{DS} =80V, V _{GS} =0V	--	--	5	uA
		V _{DS} =64V, V _{GS} =0V, T _J =125°C	--	--	100	
I _{GSS}	Gate-to-Source Leakage Current	V _{GS} =+20V, V _{DS} =0V	--	--	+100	nA
		V _{GS} =-20V, V _{DS} =0V	--	--	-100	
ON Characteristics		(T _J =25°C, unless otherwise specified)				
Symbol	Parameter	Test Conditions	Min.	Typ.	Max.	Unit
R _{DS(ON)}	Static Drain-to-Source On-Resistance	V _{GS} =10V, I _D =24A ^[5]	--	4.0	4.8	mΩ
V _{GS(TH)}	Gate Threshold Voltage	V _{DS} =V _{GS} , I _D =250uA	2.0	--	4.0	V
g _{fs}	Forward Transconductance	V _{DS} =10V, I _D =80A ^[5]	-	130	-	S
Dynamic Characteristics		Essentially independent of operating temperature				
Symbol	Parameter	Test Conditions	Min.	Typ.	Max.	Unit
C _{iss}	Input Capacitance	V _{GS} =0V, V _{DS} =25V, f=1.0MHZ	--	9300	--	pF
C _{oss}	Output Capacitance		--	650	--	
C _{rss}	Reverse Transfer Capacitance		--	260	--	
R _g	Gate Series Resistance	f=1.0MHZ	--	2.7	--	Ω
Q _g	Total Gate Charge	V _{DD} =40V, I _D =80A, V _{GS} =0 to 10V	--	115	--	nC
Q _{gs}	Gate-to-Source Charge		--	40	--	
Q _{gd}	Gate-to-Drain (Miller) Charge		--	30	--	
Resistive Switching Characteristics		Essentially independent of operating temperature				
Symbol	Parameter	Test Conditions	Min.	Typ.	Max.	Unit
t _{d(ON)}	Turn-on Delay Time	V _{DD} =40V, I _D =40A, V _{GS} = 10V, R _G =10Ω	--	50	--	nS
t _{rise}	Rise Time		--	135	--	
t _{d(OFF)}	Turn-Off Delay Time		--	112	--	
t _{fall}	Fall Time		--	75	--	
Source-Drain Body Diode Characteristics		(T _J =25°C, unless otherwise specified)				
Symbol	Parameter	Test Conditions	Min	Typ.	Max.	Unit
I _{SD}	Continuous Source Current ^[2]	Integral PN-diode in MOSFET	--	--	160	A
I _{SM}	Pulsed Source Current ^[2]		--	--	640	
V _{SD}	Diode Forward Voltage	I _S =80A, V _{GS} =0V	--	--	1.2	V
t _{rr}	Reverse recovery time	V _{GS} =0V, I _F =80A, diF/dt=100A/μs	--	85	--	ns
Q _{rr}	Reverse recovery charge		--	205	--	nC

Note:[1] T_J = +25 °C to +175 °C.

[2] Silicon limited current only.

[3] Package limited current .

[4] Repetitive rating; pulse width limited by maximum junction temperature.

[5] Pulse width ≤ 380μs; duty cycle ≤ 2%.

8. Test circuits and waveforms

Figure 1. Maximum Effective Thermal Impedance, Junction-to-Case

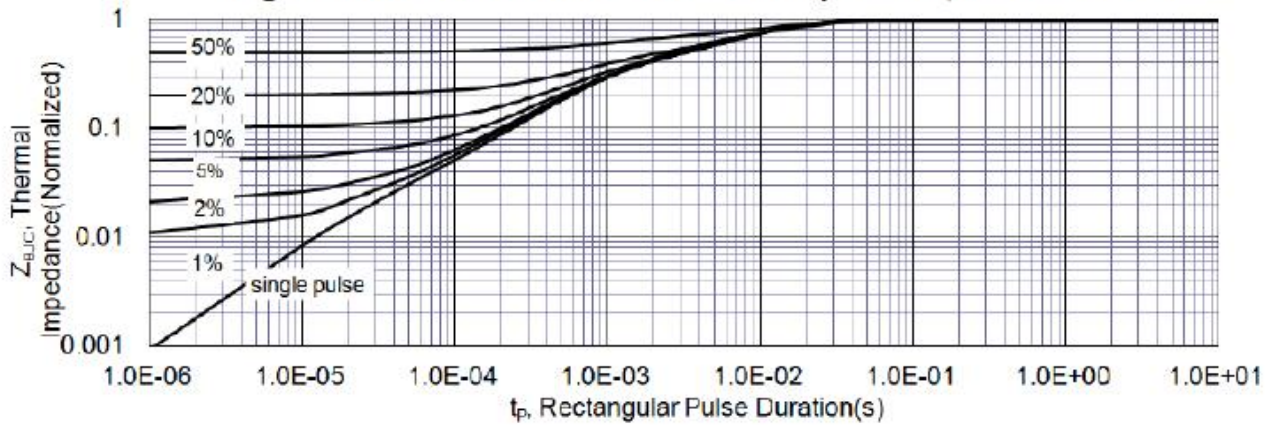

Figure 2. Maximum Power Dissipation vs. Case Temperature

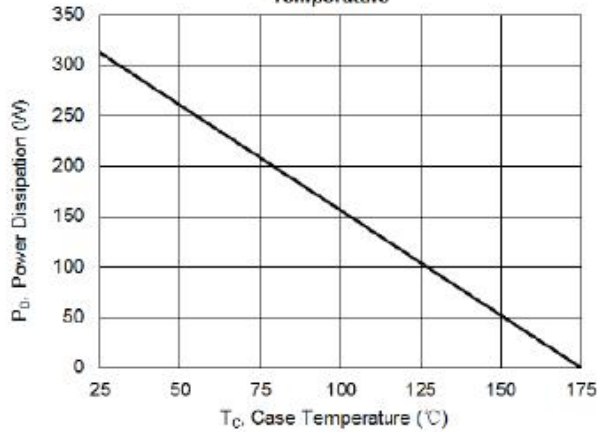

Figure 3. Maximum Continuous Drain Current vs. Case Temperature

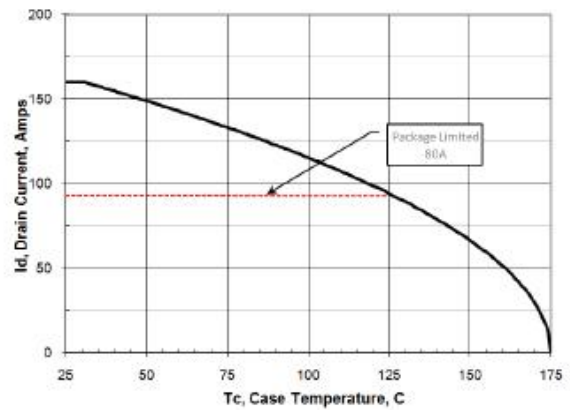

Figure 4. Typical Output Characteristics

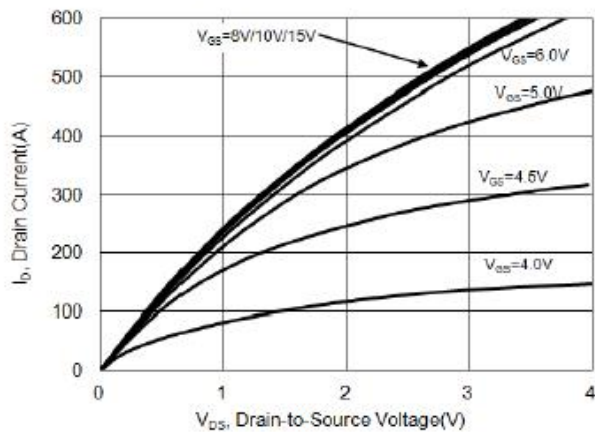

Figure 5. Typical Drain-to-Source ON Resistance vs. Gate Voltage

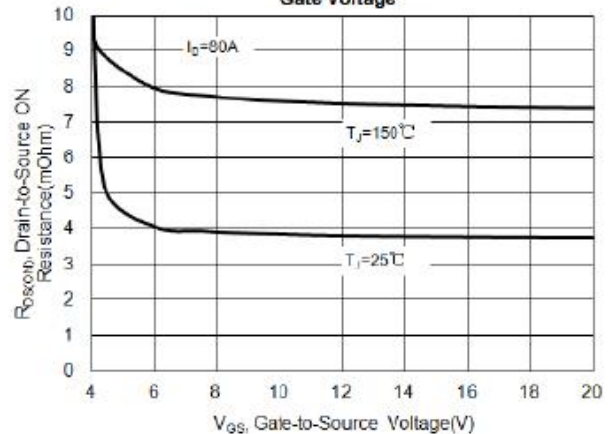

Figure 6. Maximum Peak Current Capability

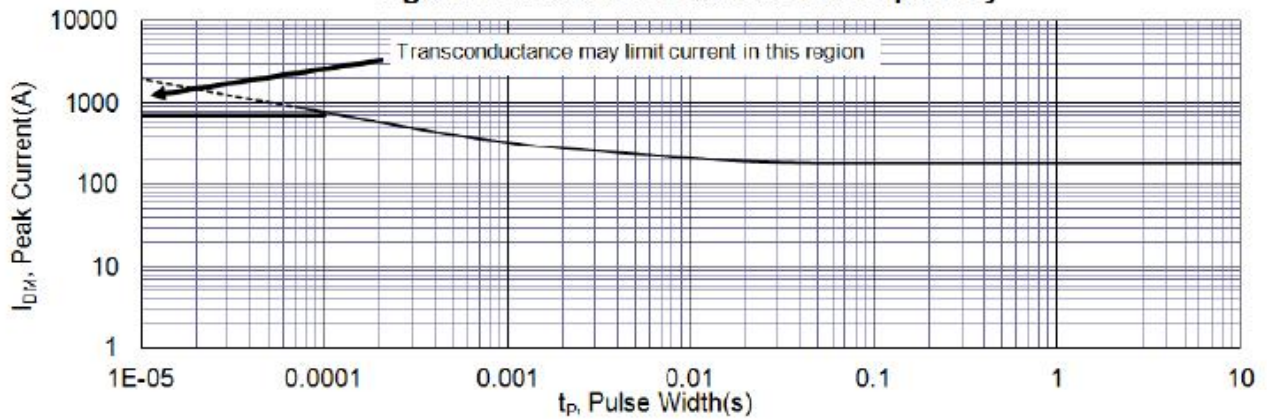

Figure 7. Typical Transfer Characteristics

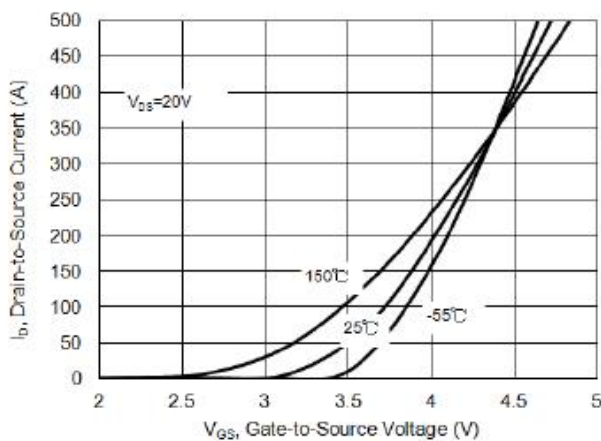

Figure 8. Unclamped Inductive Switching Capability

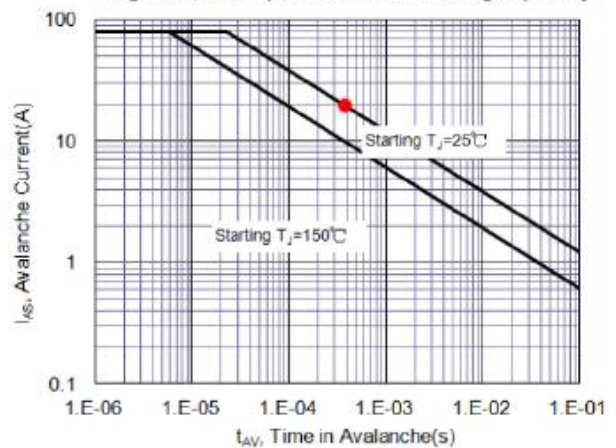

Figure 9. Typical Drain-to-Source ON Resistance

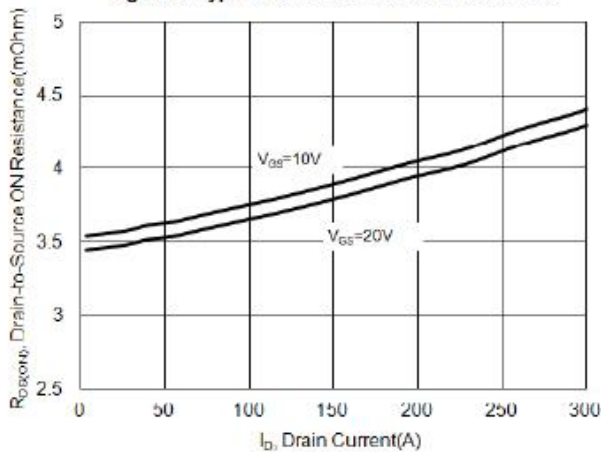
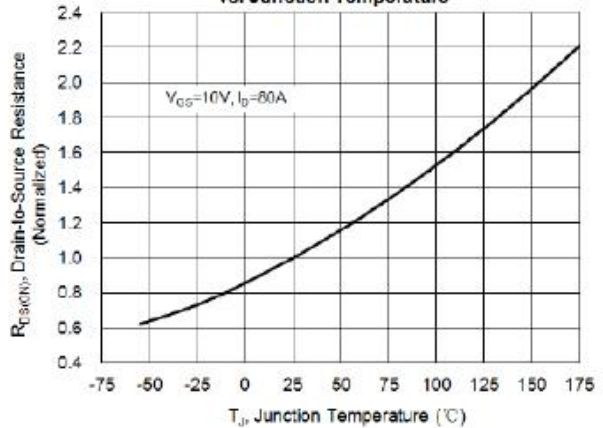
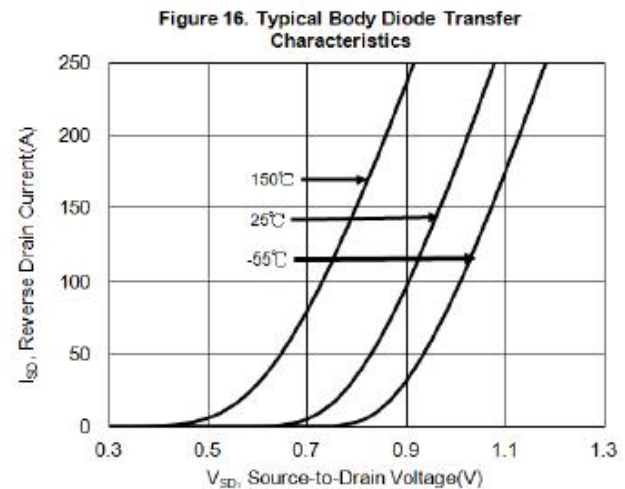
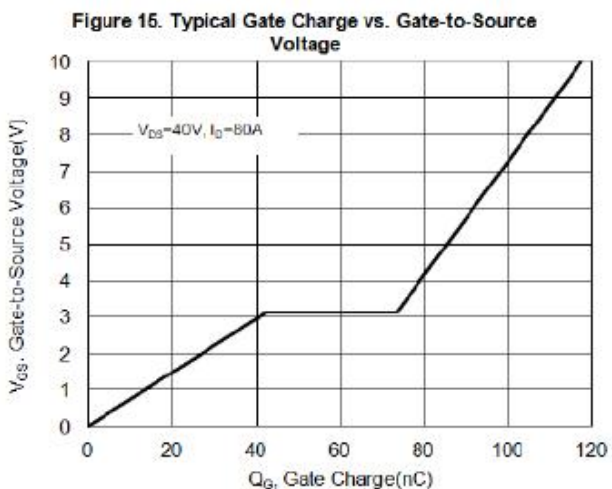
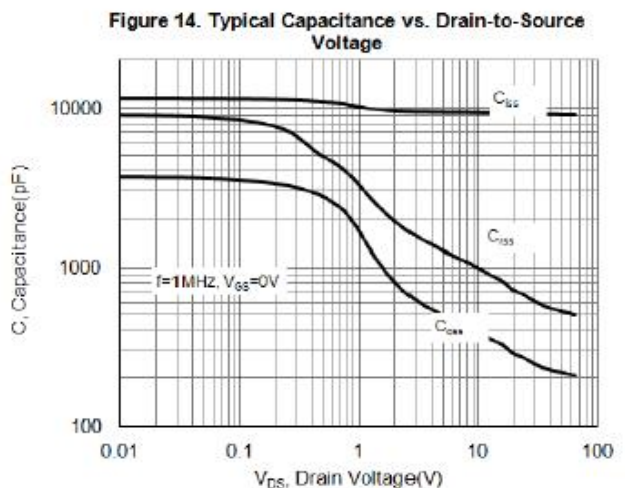
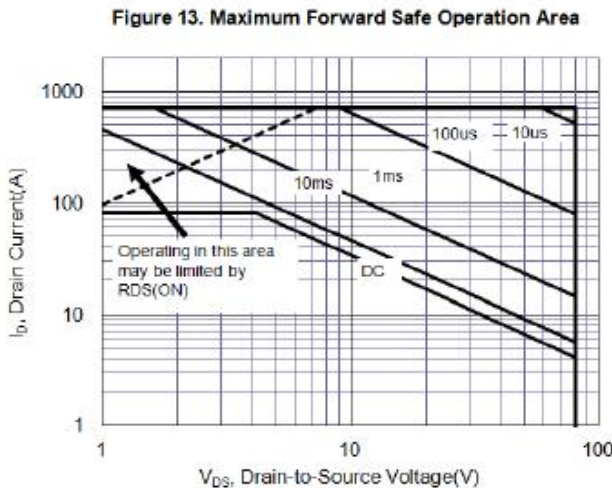
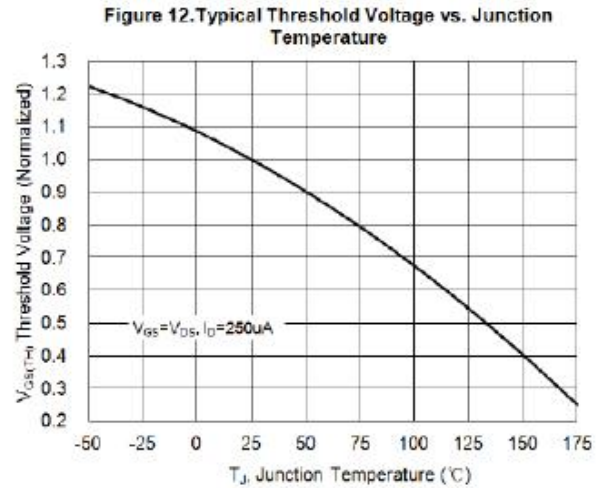
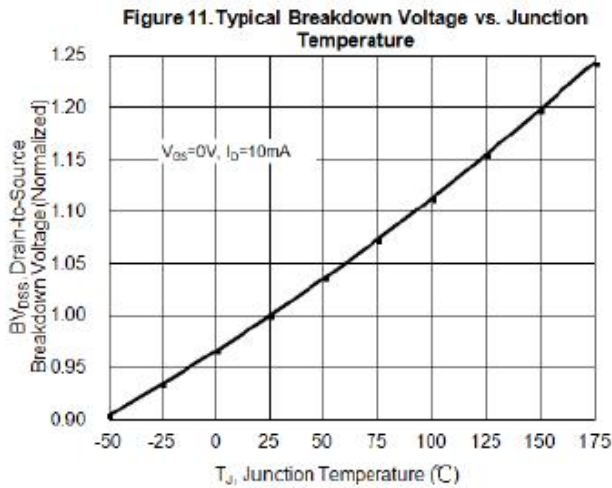

Figure 10. Typical Drain-to-Source On Resistance vs. Junction Temperature





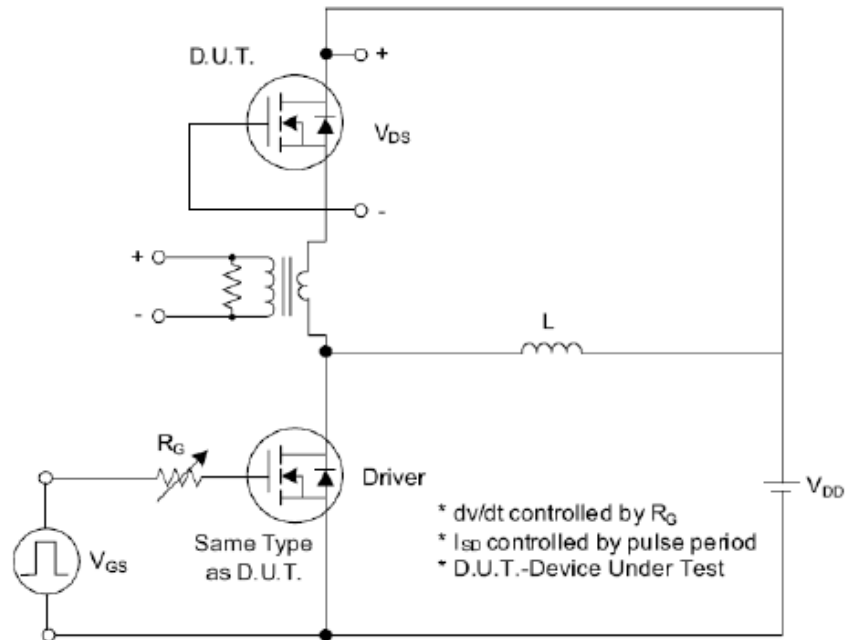

Fig. 1.1 Peak Diode Recovery dv/dt Test Circuit

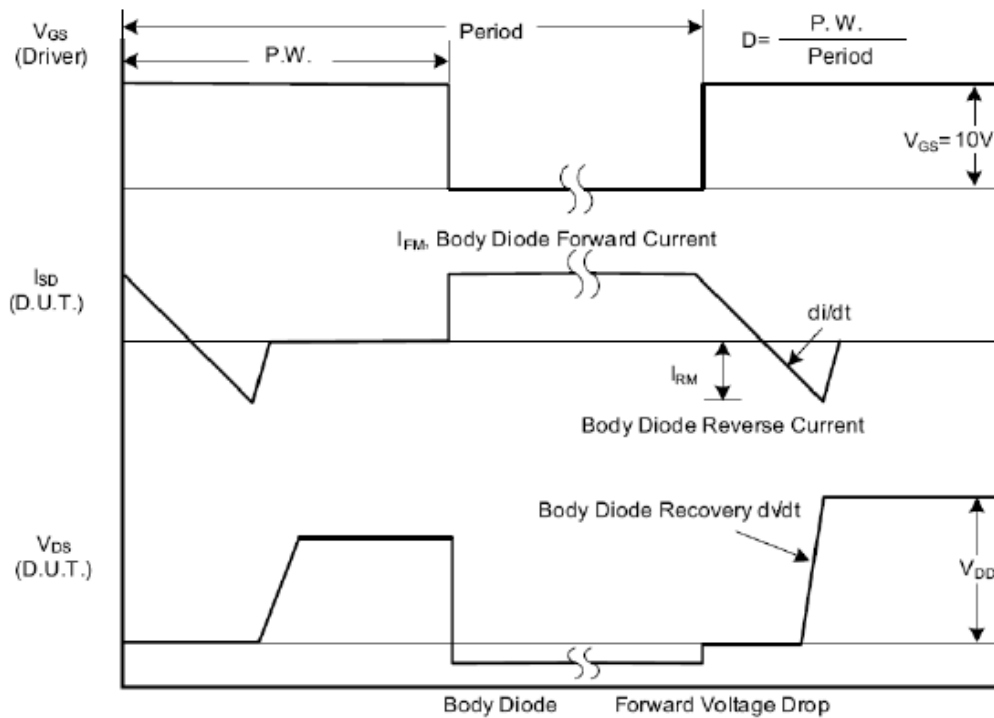

Fig. 1.2 Peak Diode Recovery dv/dt Waveforms

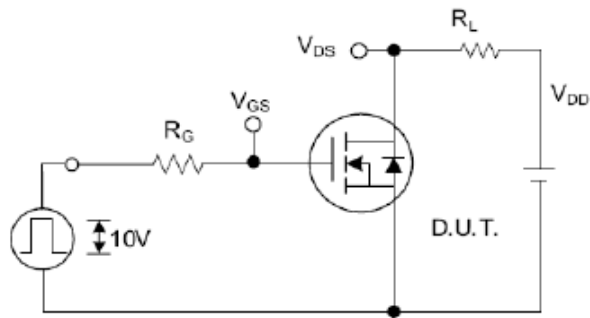

Fig. 2.1 Switching Test Circuit

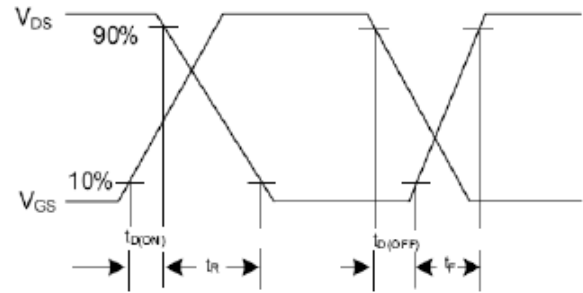

Fig. 2.2 Switching Waveforms

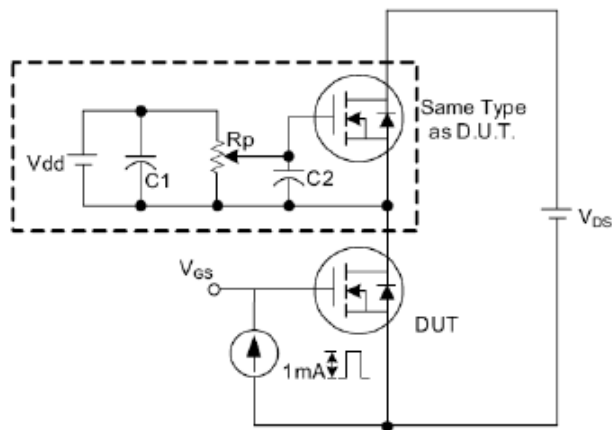

Fig. 3.1 Gate Charge Test Circuit

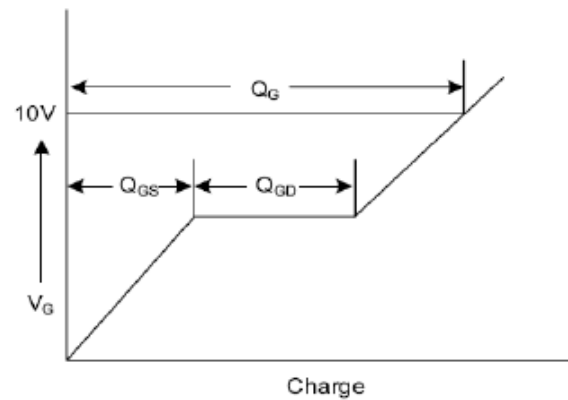

Fig. 3.2 Gate Charge Waveform

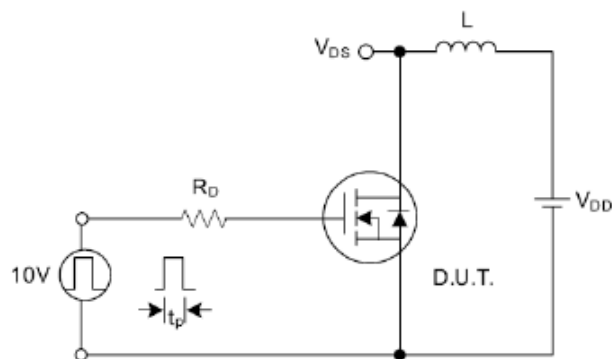

Fig. 4.1 Unclamped Inductive Switching Test Circuit

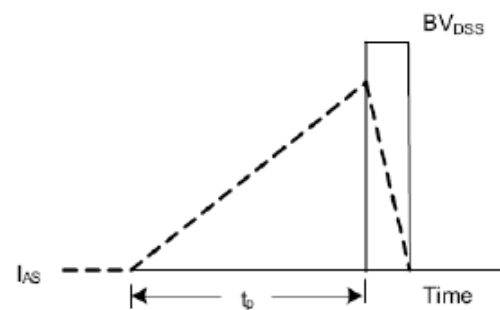

Fig. 4.2 Unclamped Inductive Switching Waveforms

X-ON Electronics

Largest Supplier of Electrical and Electronic Components

Click to view similar products for [MOSFET](#) category:

Click to view products by [KIA](#) manufacturer:

Other Similar products are found below :

[IRFD120](#) [JANTX2N5237](#) [2SK2267\(Q\)](#) [BUK455-60A/B](#) [TK100A10N1,S4X\(S](#) [MIC4420CM-TR](#) [VN1206L](#) [NDP4060](#) [SI4482DY](#)
[IRS2092STRPBF-EL](#) [IPS70R2K0CEAKMA1](#) [TK31J60W5,S1VQ\(O](#) [TK31J60W,S1VQ\(O](#) [TK16J60W,S1VQ\(O](#) [2SK2614\(TE16L1,Q\)](#)
[DMN1017UCP3-7](#) [EFC2J004NUZTDG](#) [P85W28HP2F-7071](#) [DMN1053UCP4-7](#) [NTE2384](#) [DMC2700UDMQ-7](#) [DMN2080UCB4-7](#)
[DMN61D9UWQ-13](#) [US6M2GTR](#) [DMN31D5UDJ-7](#) [DMP22D4UFO-7B](#) [IPS60R3K4CEAKMA1](#) [DMN1006UCA6-7](#) [DMN16M9UCA6-7](#)
[STF5N65M6](#) [IRF40H233XTMA1](#) [STU5N65M6](#) [DMN6022SSD-13](#) [DMN13M9UCA6-7](#) [DMTH10H4M6SPS-13](#) [IPS60R360PFD7SAKMA1](#)
[DMN2990UFB-7B](#) [SSM3K35CT,L3F](#) [IPLK60R1K0PFD7ATMA1](#) [2N7002W-G](#) [MCAC30N06Y-TP](#) [IPWS65R035CFD7AXKSA1](#)
[MCQ7328-TP](#) [SSM3J143TU,LXHF](#) [DMN12M3UCA6-7](#) [PJMF280N65E1_T0_00201](#) [PJMF380N65E1_T0_00201](#)
[PJMF280N60E1_T0_00201](#) [PJMF600N65E1_T0_00201](#) [PJMF900N65E1_T0_00201](#)