

1. Features

- n Proprietary New Planar Technology
- n $R_{DS(ON)}=50m\ \Omega_{(typ.)}@V_{GS}=10V$
- n Low Gate Charge Minimize Switching Loss
- n Fast Recovery Body Diode

2. Application

- n DC-DC Converters
- n DC-AC Inverters for UPS
- n SMPS and Motor controls

3. Pin configuration

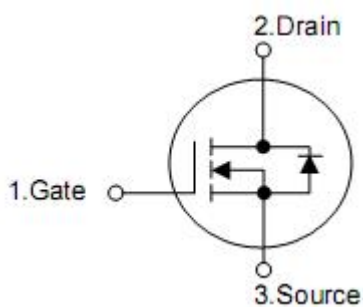
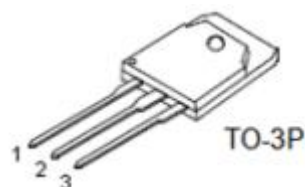
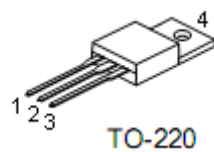

Pin	Function
1	Gate
2	Drain
3	Source
4	Drain

4. Ordering Information

Part Number	Package	Brand
KNP9120A	TO-220	KIA
KNH9120A	TO-3P	KIA

5. Absolute maximum ratings

(T_C= 25°C , unless otherwise specified)

Parameter	Symbol	Rating		Units
		TO-220	TO-3P	
Drain-source voltage ^[1]	V _{DSS}	200		V
Gate-source voltage	V _{GSS}	±20		V
Continuous Drain Current	I _D	40		A
Continuous Drain Current @T _c =100°C	I _D @ T _C =100°C	Figure3		A
Pulsed Drain Current at V _{GS} =10V ^[2]	I _{DM}	Figure6		A
Avalanche energy	E _{AS}	1200		mJ
Single pulse				
Peak Diode Recovery dv/dt ^[3]	dv/dt ^[3]	5.0		V/ns
Power Dissipation	P _D	125	150	W
Derating Factor above 25 °C		1.0	1.2	W/°C
Maximum Temperature for Soldering Leads at 0.063in(1.6mm) form Case for 10 Seconds	T _L T _{PAK}	300 260		°C
Storage temperature	T _{STG}	-55~+150		°C

Caution: Stresses greater than those listed in the "Absolute Maximum Ratings" may cause permanent damage to the device.

6. Thermal Characteristics

Symbol	Parameter	Rating		Unit
		TO-220	TO-3P	
R _{θJC}	Thermal Resistance, Junction-to-Case	1.0	0.83	°C/W
R _{θJA}	Thermal Resistance, Junction-to-Ambient	62		

7. Electrical characteristics

Parameter	Symbol	Conditions	Min	Typ	Max	Unit
Off characteristics (T _J =25°C, unless otherwise specified)						
Drain-source breakdown voltage	BV _{DSS}	V _{GS} =0V, I _D =250μA	200	-	-	V
Drain-to-Source Leakage Current	I _{DSS}	V _{DS} =200V, V _{GS} =0V	-	-	1	μA
		V _{DS} =160V, V _{GS} =0V T _J =125 °C	-	-	100	μA
Gate-to-source Leakage Current	I _{GSS}	V _{GS} =+20V, V _{DS} =0V	-	-	+100	nA
		V _{GS} =-20V, V _{DS} =0V	-	-	-100	nA
On characteristics (T _J =25°C, unless otherwise specified)						
Gate threshold voltage	V _{GS(TH)}	V _{DS} =V _{GS} , I _D =250μA	2.0	-	4.0	V
Static drain-source on-resistance	R _{DS(ON)}	V _{GS} =10V, I _D =20A	-	50	65	mΩ
Forward Transconductance ^[4]	G _{FS}	V _{DS} =15V, I _D =20A	-	65	-	S
Dynamic characteristics (Essentially independent of operating temperature)						
Input capacitance	C _{ISS}	V _{DS} =25V, V _{GS} =0V, f=1.0 MHz	-	2800	-	pF
Output capacitance	C _{OSS}		-	305	-	pF
Reverse transfer capacitance	C _{RSS}		-	110	-	pF
Turn-on delay time	t _{D(ON)}	V _{DD} =100V, I _D =20A, R _G =3.9Ω, V _{GS} =10V	-	20	-	ns
Rise time	t _R		-	30	-	ns
Turn-off delay time	t _{D(OFF)}		-	65	-	ns
Fall time	t _F		-	25	-	ns
Switching characteristics (Essentially independent of operating temperature)						
Total gate charge	Q _G	V _{DD} =100V, I _D =20A V _{GS} =0 to 10V	-	97	-	nC
Gate-source charge	Q _{GS}		-	14	-	nC
Gate-drain charge	Q _{GD}		-	39	-	nC
Switching characteristics (T _J =25°C, unless otherwise specified)						
Drain-source diode forward voltage	V _{SD}	V _{GS} =0V, I _S =40A	-	-	1.5	V
Continuous drain-source current ^[4]	I _{SD}	Integral PN-diode in MOSFET	-	-	40	A
Pulsed drain-source current ^[4]	I _{SM}		-	-	160	A
Reverse recovery time	t _{rr}	V _{GS} =0V, I _F =20A	-	280	-	ns
Reverse recovery charge	Q _{rr}	di _F /dt=100A/μs	-	420	-	μC

NOTE:[1] T_J=+25°C to +150°C ;

[2] Repetitive rating; pulse width limited by maximum junction temperature;

[3] I_{SD}= 20A di/dt < 100 A/μs, V_{DD} < BVDSS, T_J=+150°C;

[4] Pulse width≤380μs; duty cycle≤2%.

8. Test circuits and waveforms

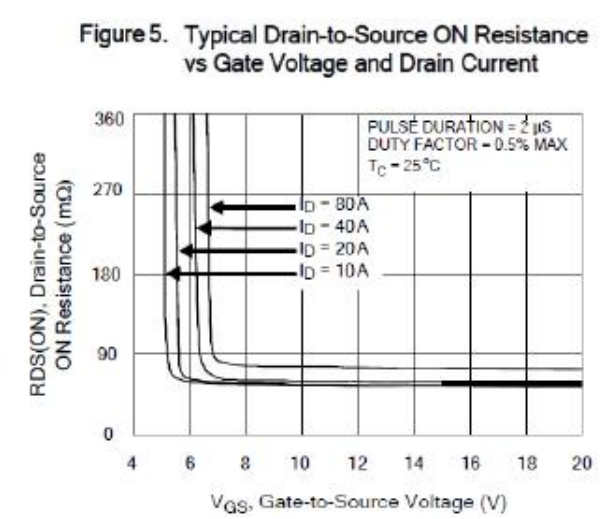
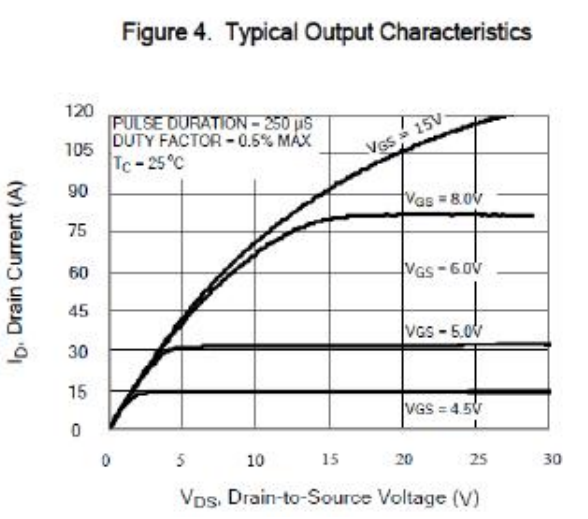
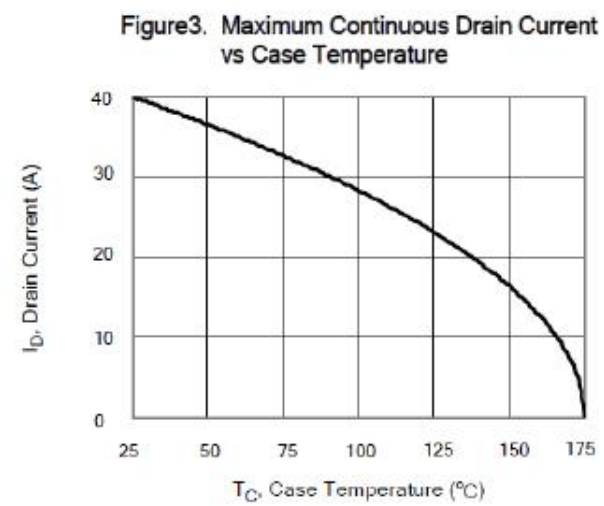
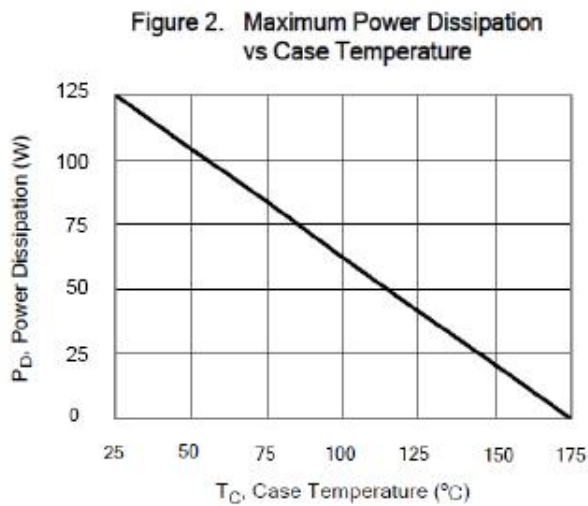
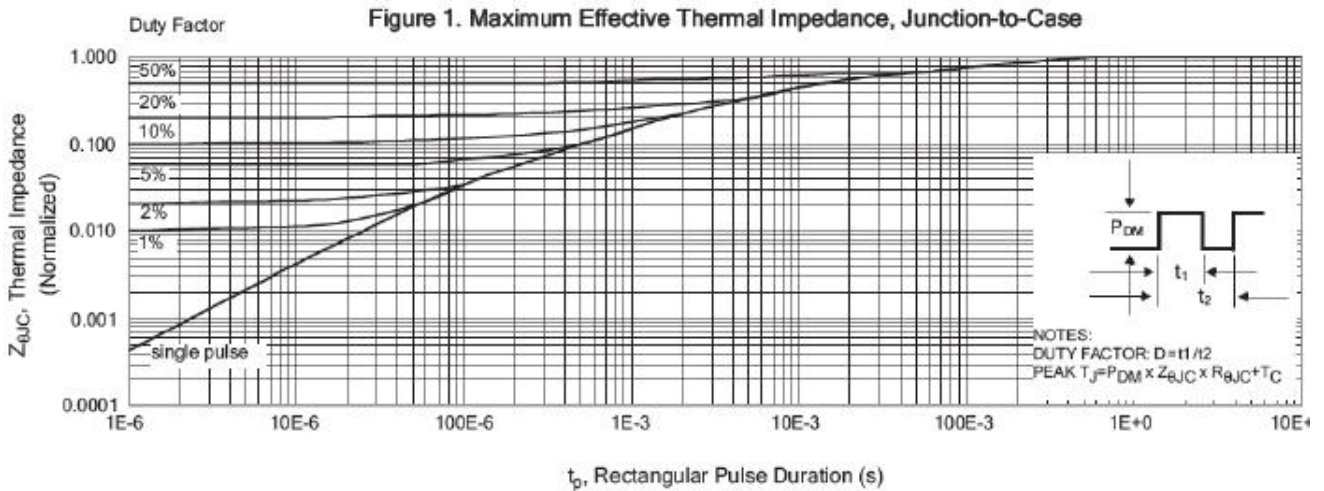

Figure 6. Maximum Peak Current Capability

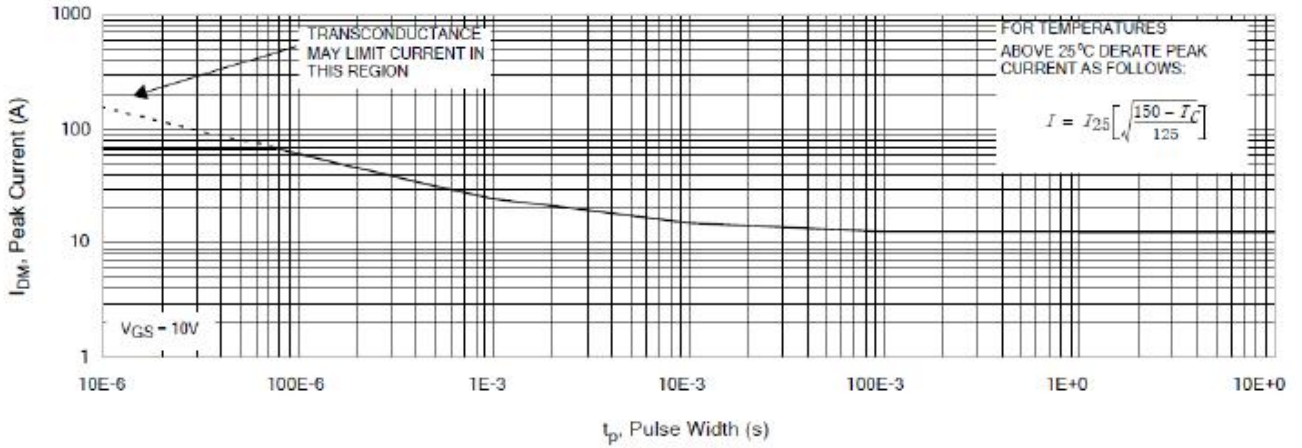

Figure 7. Typical Transfer Characteristics

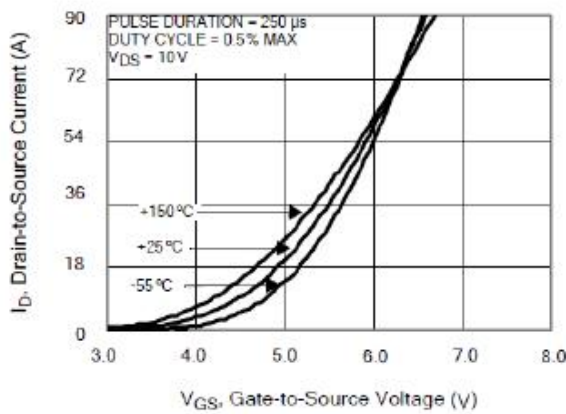

Figure 9. Typical Drain-to-Source ON Resistance vs Drain Current

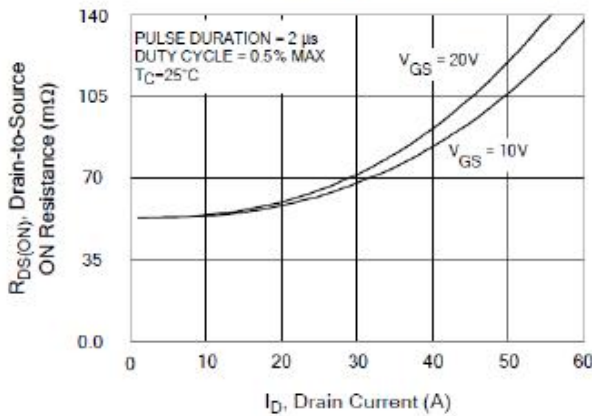

Figure 8. Unclamped Inductive Switching Capability

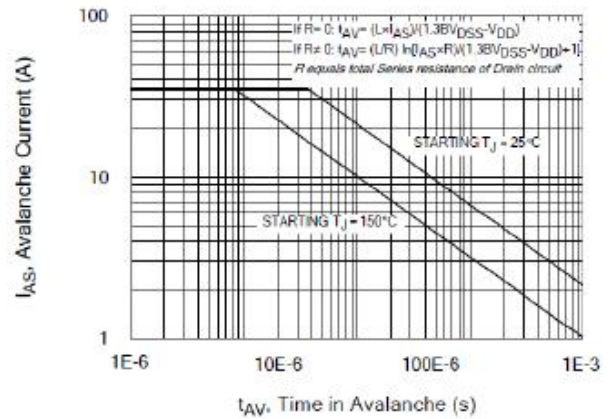

Figure 10. Typical Drain-to-Source ON Resistance vs Junction Temperature

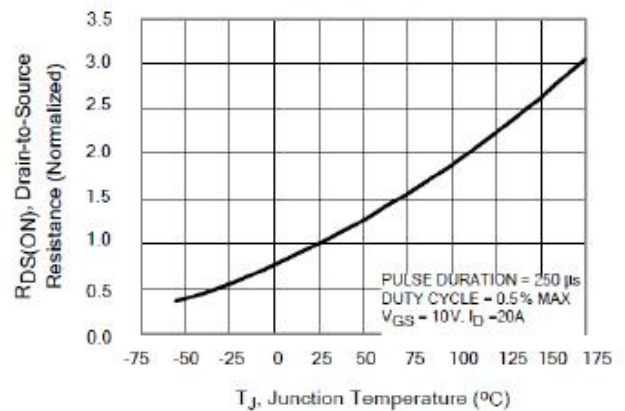

Figure 11. Typical Breakdown Voltage vs Junction Temperature

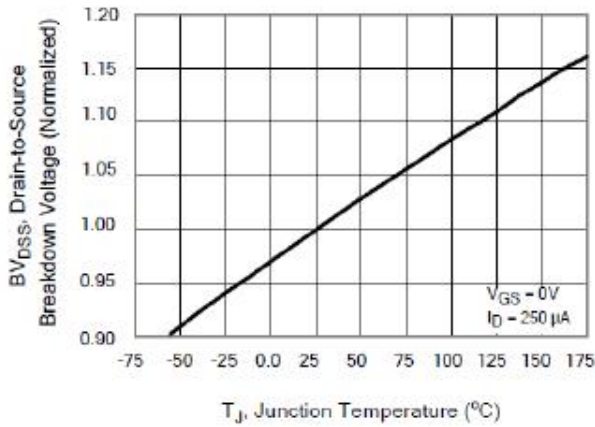

Figure 12. Typical Threshold Voltage vs Junction Temperature

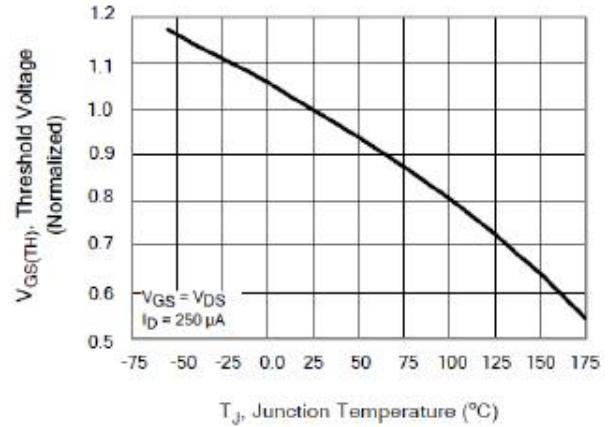

Figure 13. Maximum Forward Bias Safe Operating Area

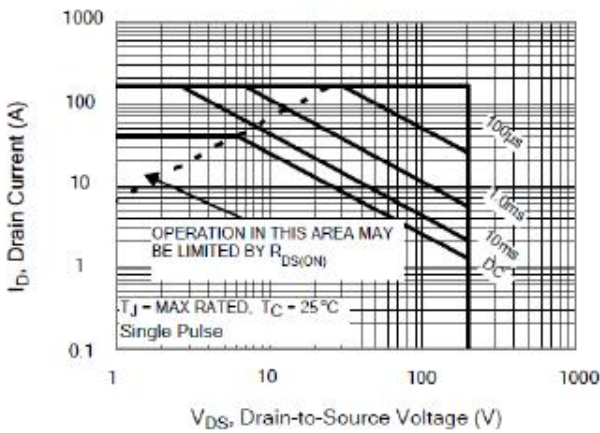

Figure 14. Typical Capacitance vs Drain-to-Source Voltage

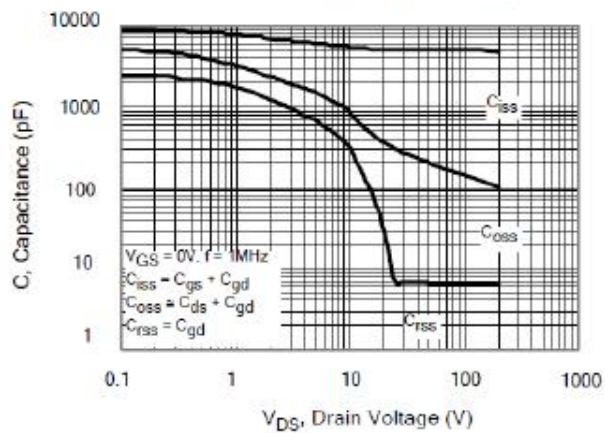

Figure 15. Typical Gate Charge

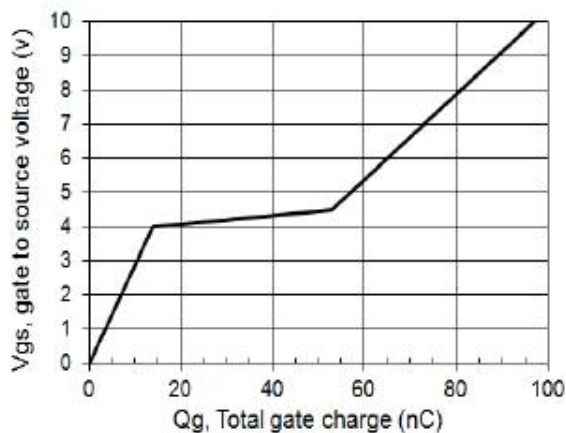
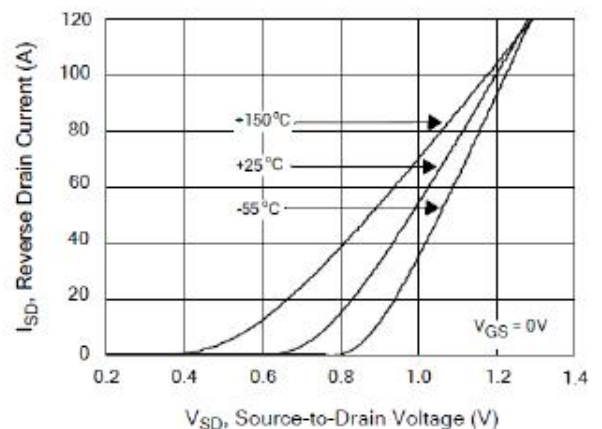

Figure 16. Typical Body Diode Transfer Characteristics



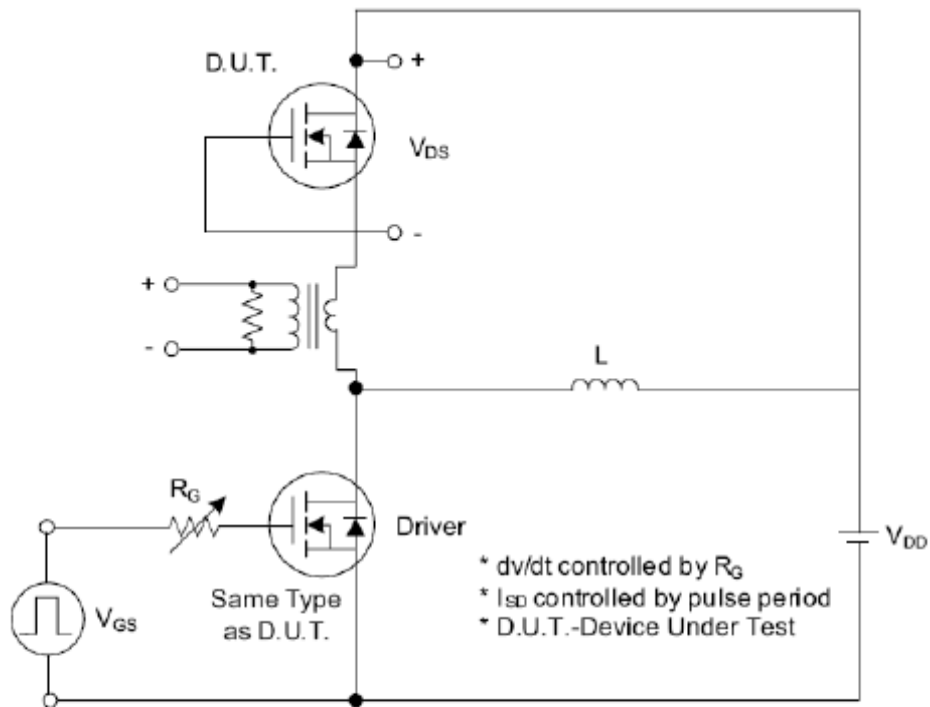

Fig. 1.1 Peak Diode Recovery dv/dt Test Circuit

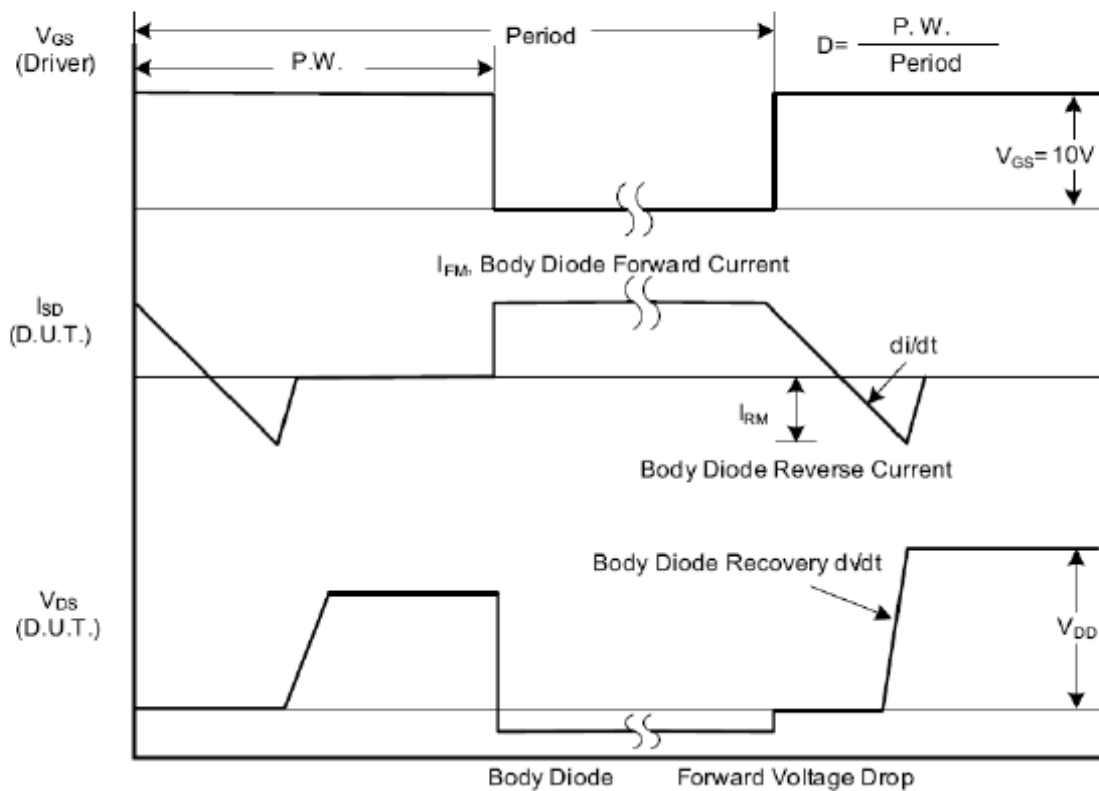

Fig. 1.2 Peak Diode Recovery dv/dt Waveforms

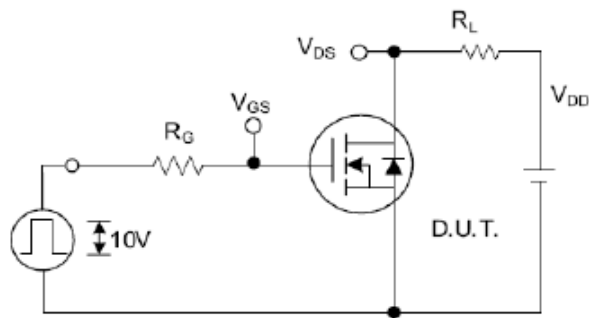

Fig. 2.1 Switching Test Circuit

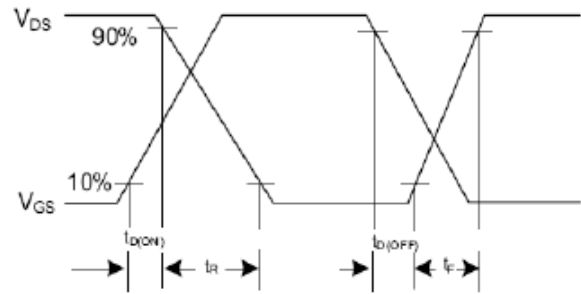

Fig. 2.2 Switching Waveforms

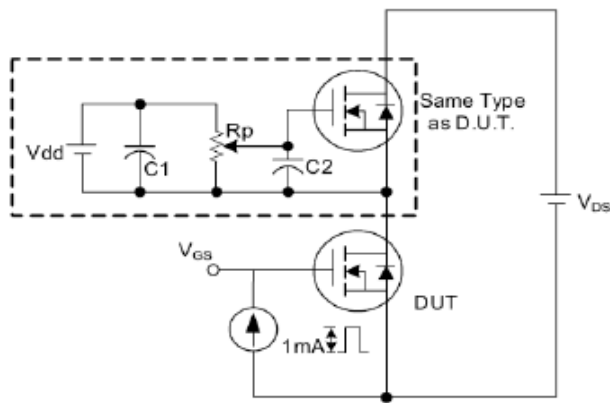

Fig. 3.1 Gate Charge Test Circuit

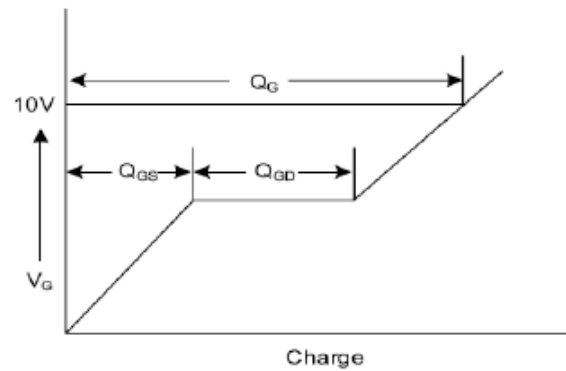

Fig. 3.2 Gate Charge Waveform

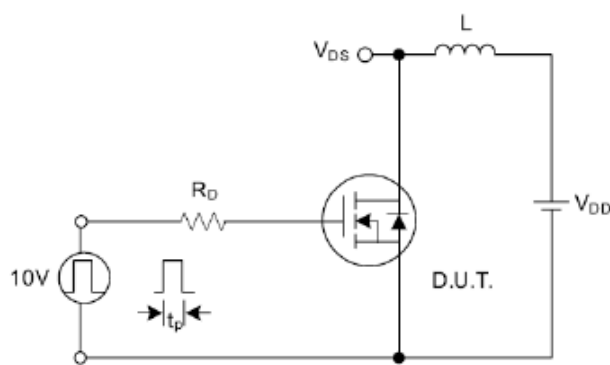

Fig. 4.1 Unclamped Inductive Switching Test Circuit

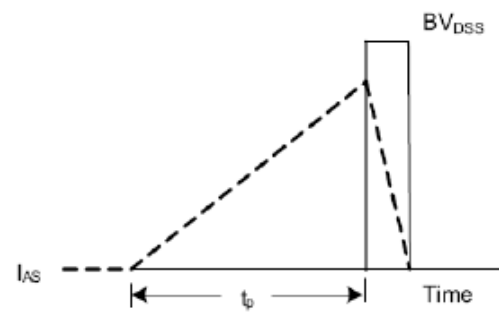

Fig. 4.2 Unclamped Inductive Switching Waveforms

X-ON Electronics

Largest Supplier of Electrical and Electronic Components

Click to view similar products for [MOSFET](#) category:

Click to view products by [KIA](#) manufacturer:

Other Similar products are found below :

[614233C](#) [648584F](#) [FDPF9N50NZ](#) [IRFD120](#) [IRFF430](#) [JANTX2N5237](#) [2N7000](#) [FCA20N60_F109](#) [FDZ595PZ](#) [2SK2267\(Q\)](#) [2SK2545\(Q,T\)](#)
[405094E](#) [423220D](#) [MIC4420CM-TR](#) [VN1206L](#) [614234A](#) [715780A](#) [SSM6J414TU,LF\(T](#) [751625C](#) [PSMN4R2-30MLD](#)
[TK31J60W5,S1VQ\(O](#) [2SK2614\(TE16L1,Q\)](#) [DMN1017UCP3-7](#) [EFC2J004NUZTDG](#) [FCAB21350L1](#) [P85W28HP2F-7071](#) [DMN1053UCP4-7](#)
[NTE2384](#) [NTE2969](#) [NTE6400A](#) [DMN61D9UWQ-13](#) [US6M2GTR](#) [DMN31D5UDJ-7](#) [SSM6P54TU,LF](#) [DMP22D4UFO-7B](#)
[IPS60R3K4CEAKMA1](#) [DMN1006UCA6-7](#) [DMN16M9UCA6-7](#) [STF5N65M6](#) [STU5N65M6](#) [C3M0021120D](#) [DMN13M9UCA6-7](#)
[BSS340NWH6327XTSA1](#) [MCM3400A-TP](#) [DMTH10H4M6SPS-13](#) [IPS60R1K0PFD7SAKMA1](#) [IPS60R360PFD7SAKMA1](#)
[IPS60R600PFD7SAKMA1](#) [IPS60R210PFD7SAKMA1](#) [DMN2990UFB-7B](#)