

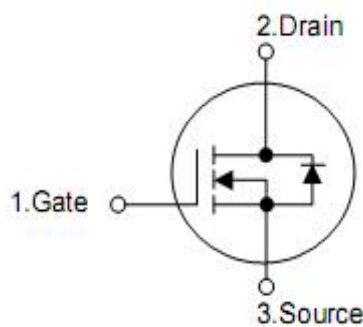
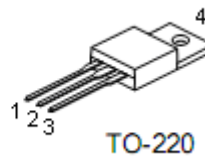
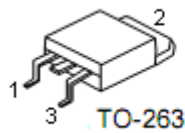
## 1. General Features

- n Proprietary New Trench Technology
- n  $R_{DS(ON),typ.}=4.0m\Omega@V_{GS}=10V$
- n Low Gate Charge Minimize Switching Loss
- n Fast Recovery Body Diode

## 2. Applications

- n High efficiency DC/DC converters
- n Synchronous Rectification
- n UPS Inverter

## 3. Pin configuration



Pin	Function
1	Gate
2	Drain
3	Source
4	Drain

## 4. Ordering Information

Part Number	Package	Brand
KNP2708A	TO-220	KIA
KNB2708A	TO-263	KIA

## 5. Absolute maximum ratings

(T<sub>C</sub>= 25 °C , unless otherwise specified)

Symbol	Parameter	Rating	Unit
V <sub>DSS</sub>	Drain-to-Source Voltage <sup>[1]</sup>	80	V
V <sub>GSS</sub>	Gate-to-Source Voltage	±20	
I <sub>D</sub>	Continuous Drain Current <sup>[2]</sup>	160	A
	Continuous Drain Current <sup>[3]</sup>	80	
I <sub>D</sub> @ T <sub>C</sub> =100°C	Continuous Drain Current@T <sub>C</sub> =100 °C <sup>[2]</sup>	116	
I <sub>DM</sub>	Pulsed Drain Current at V <sub>GS</sub> =10V <sup>[2,4]</sup>	640	
E <sub>AS</sub>	Single Pulse Avalanche Energy	1100	mJ
dv /dt	Peak Diode Recovery dv/dt <sup>[3]</sup>	5.0	V/ns
P <sub>D</sub>	Power Dissipation	313	W
	Derating Factor above 25 °C	2.08	W/ °C
T <sub>L</sub> T <sub>PAK</sub>	Maximum Temperature for Soldering Leads at 0.063in (1.6mm) from Case for 10 seconds, Package Body for 10 seconds	300 260	°C
T <sub>J</sub> &T <sub>STG</sub>	Operating and Storage Temperature Range	-55 to 175	

*Caution: Stresses greater than those listed in the “Absolute Maximum Ratings” may cause permanent damage to the device.*

## 6. Thermal characteristics

Symbol	Parameter	Rating	Unit
R <sub>θJC</sub>	Thermal Resistance, Junction-to-Case	0.48	°C /W
R <sub>θJA</sub>	Thermal Resistance, Junction-to-Ambient	62	

## 7. Electrical characteristics

OFF Characteristics		(T <sub>J</sub> =25°C, unless otherwise specified)				
Symbol	Parameter	Test Conditions	Min.	Typ.	Max.	Unit
B <sub>V</sub> DSS	Drain-to-Source Breakdown Voltage	V <sub>GS</sub> =0V, I <sub>D</sub> =250μA	80	--	--	V
I <sub>DSS</sub>	Drain-to-Source Leakage Current	V <sub>DS</sub> =80V, V <sub>GS</sub> =0V	--	--	5	μA
		V <sub>DS</sub> =64V, V <sub>GS</sub> =0V, T <sub>J</sub> =125°C	--	--	100	
I <sub>GSS</sub>	Gate-to-Source Leakage Current	V <sub>GS</sub> =+20V, V <sub>DS</sub> =0V	--	--	+100	nA
		V <sub>GS</sub> =-20V, V <sub>DS</sub> =0V	--	--	-100	
ON Characteristics		(T <sub>J</sub> =25°C, unless otherwise specified)				
Symbol	Parameter	Test Conditions	Min.	Typ.	Max.	Unit
R <sub>DS(ON)</sub>	Static Drain-to-Source On-Resistance	V <sub>GS</sub> =10V, I <sub>D</sub> =24A <sup>[5]</sup>	--	4.0	4.8	mΩ
V <sub>GS(TH)</sub>	Gate Threshold Voltage	V <sub>DS</sub> =V <sub>GS</sub> , I <sub>D</sub> =250μA	2.0	--	4.0	V
g <sub>fs</sub>	Forward Transconductance	V <sub>DS</sub> =10V, I <sub>D</sub> =80A <sup>[5]</sup>	-	130	-	S
Dynamic Characteristics		Essentially independent of operating temperature				
Symbol	Parameter	Test Conditions	Min.	Typ.	Max.	Unit
C <sub>iss</sub>	Input Capacitance	V <sub>GS</sub> =0V, V <sub>DS</sub> =25V, f=1.0MHZ	--	9300	--	pF
C <sub>oss</sub>	Output Capacitance		--	650	--	
C <sub>rss</sub>	Reverse Transfer Capacitance		--	260	--	
R <sub>g</sub>	Gate Series Resistance	f=1.0MHZ	--	2.7	--	Ω
Q <sub>g</sub>	Total Gate Charge	V <sub>DD</sub> =40V, I <sub>D</sub> =80A, V <sub>GS</sub> =0 to 10V	--	115	--	nC
Q <sub>gs</sub>	Gate-to-Source Charge		--	40	--	
Q <sub>gd</sub>	Gate-to-Drain (Miller) Charge		--	30	--	
Resistive Switching Characteristics		Essentially independent of operating temperature				
Symbol	Parameter	Test Conditions	Min.	Typ.	Max.	Unit
t <sub>d(ON)</sub>	Turn-on Delay Time	V <sub>DD</sub> =40V, I <sub>D</sub> =40A, V <sub>GS</sub> = 10V, R <sub>G</sub> =10Ω	--	50	--	nS
t <sub>rise</sub>	Rise Time		--	135	--	
t <sub>d(OFF)</sub>	Turn-Off Delay Time		--	112	--	
t <sub>fall</sub>	Fall Time		--	75	--	
Source-Drain Body Diode Characteristics		(T <sub>J</sub> =25°C, unless otherwise specified)				
Symbol	Parameter	Test Conditions	Min	Typ.	Max.	Unit
I <sub>SD</sub>	Continuous Source Current <sup>[2]</sup>	Integral PN-diode in MOSFET	--	--	160	A
I <sub>SM</sub>	Pulsed Source Current <sup>[2]</sup>		--	--	640	
V <sub>SD</sub>	Diode Forward Voltage	I <sub>S</sub> =80A, V <sub>GS</sub> =0V	--	--	1.2	V
t <sub>rr</sub>	Reverse recovery time	V <sub>GS</sub> =0V, I <sub>F</sub> =80A, diF/dt=100A/μs	--	85	--	ns
Q <sub>rr</sub>	Reverse recovery charge		--	205	--	nC

Note:[1] T<sub>J</sub> = +25 °C to +175 °C.

[2] Silicon limited current only.

[3] Package limited current .

[4] Repetitive rating; pulse width limited by maximum junction temperature.

[5] Pulse width ≤ 380μs; duty cycle ≤ 2%.

8. Test circuits and waveforms

Figure 1. Maximum Effective Thermal Impedance, Junction-to-Case

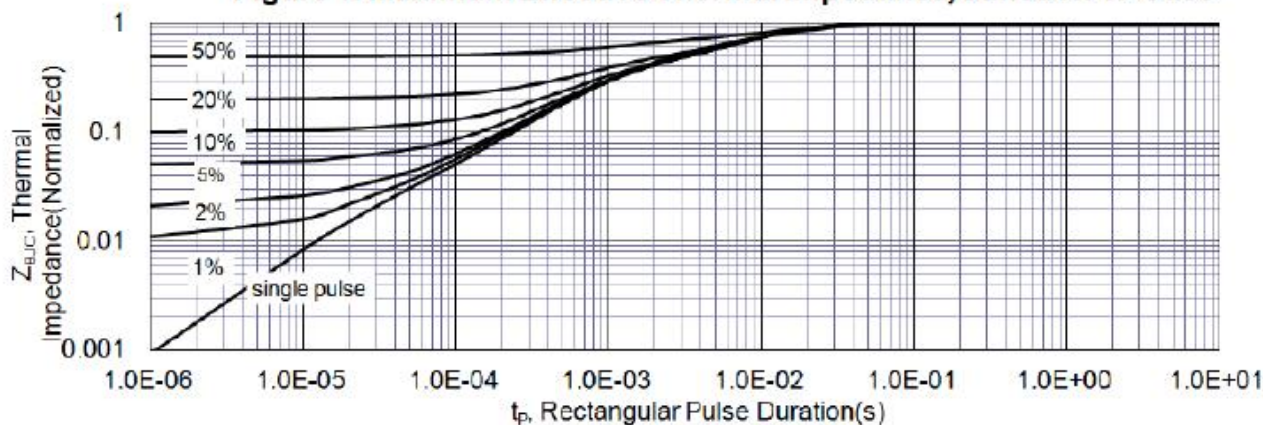


Figure 2. Maximum Power Dissipation vs. Case Temperature

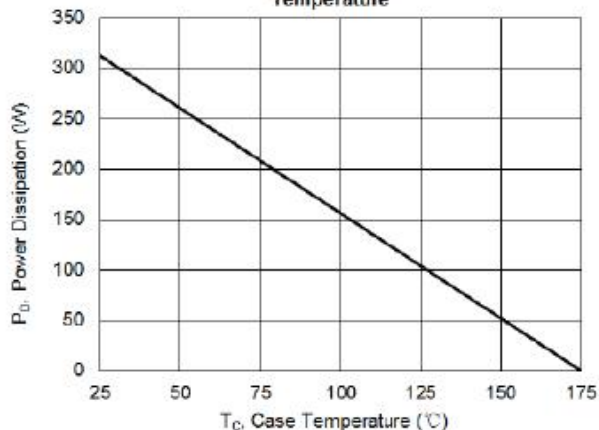


Figure 3. Maximum Continuous Drain Current vs. Case Temperature

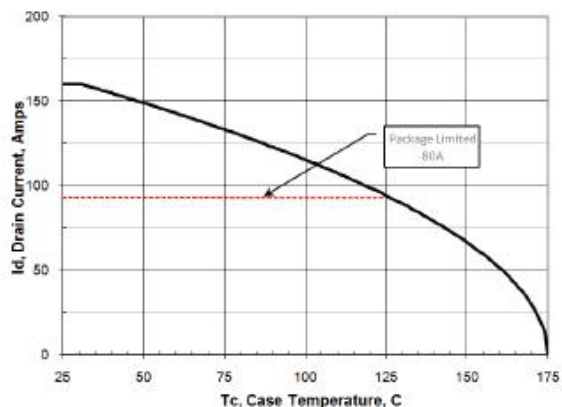


Figure 4. Typical Output Characteristics

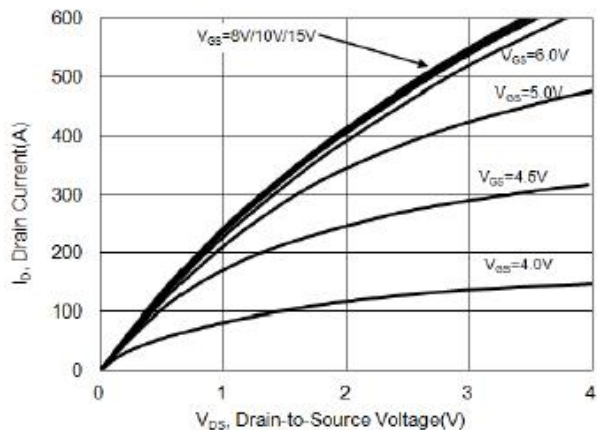
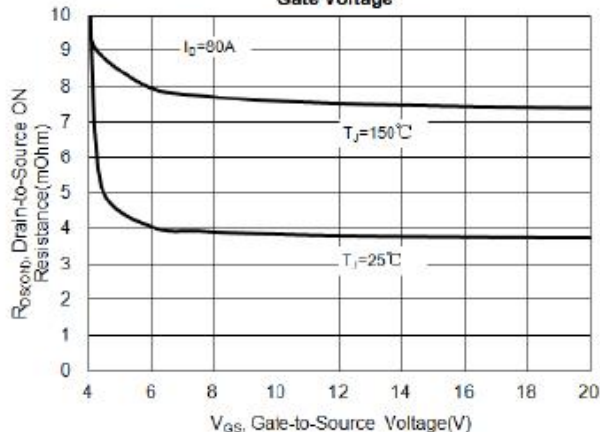
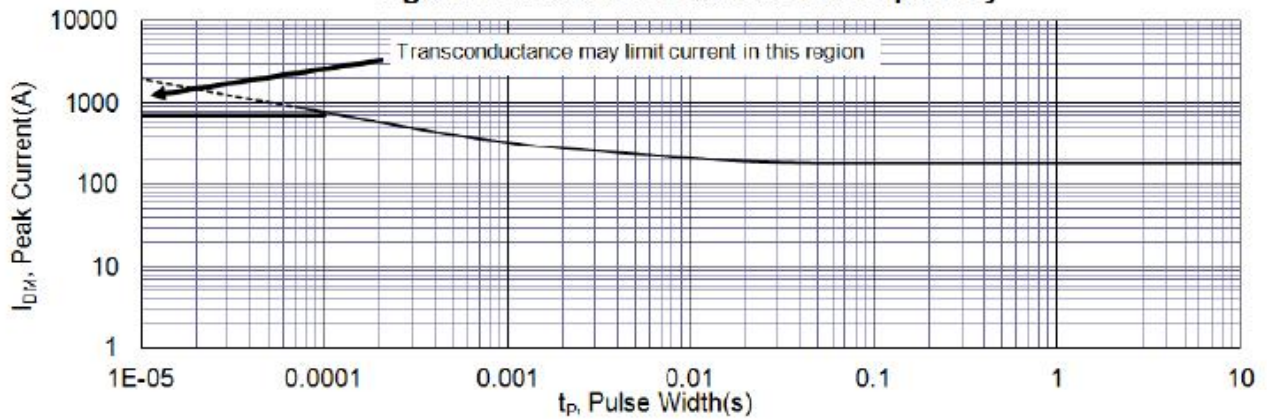


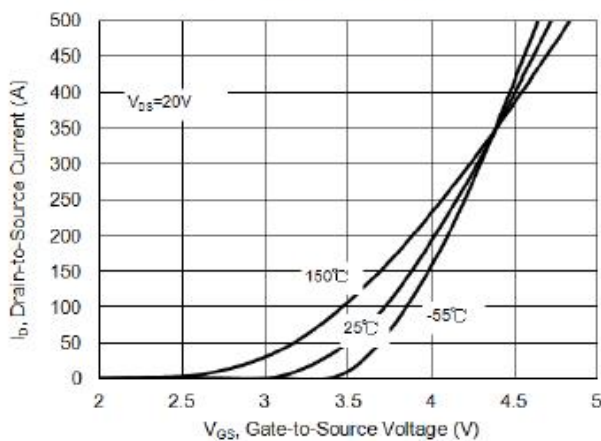
Figure 5. Typical Drain-to-Source ON Resistance vs. Gate Voltage



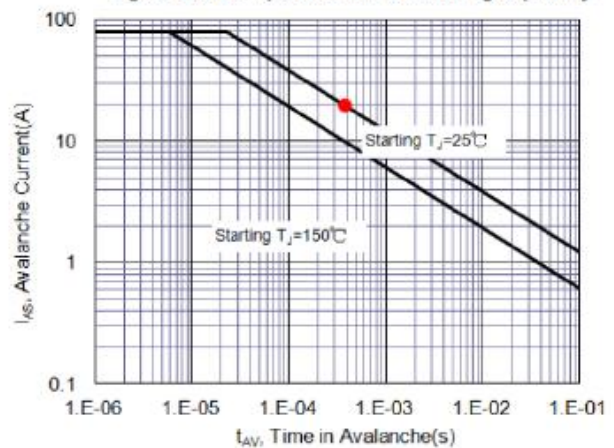
**Figure 6. Maximum Peak Current Capability**



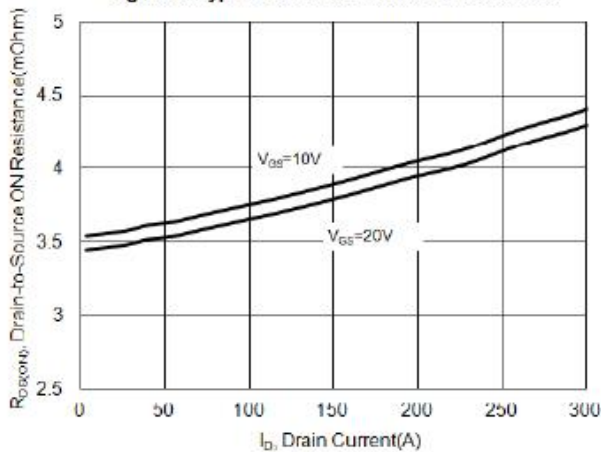
**Figure 7. Typical Transfer Characteristics**



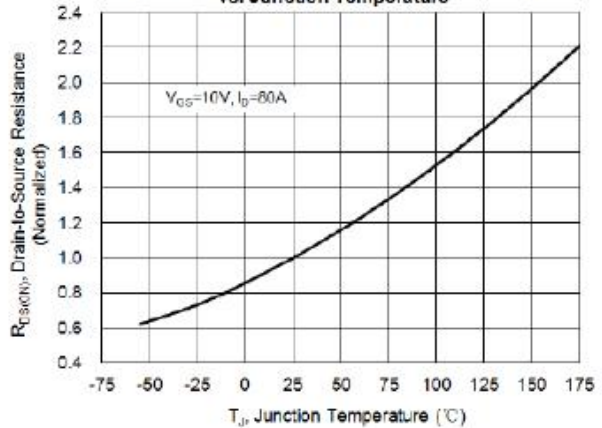
**Figure 8. Unclamped Inductive Switching Capability**

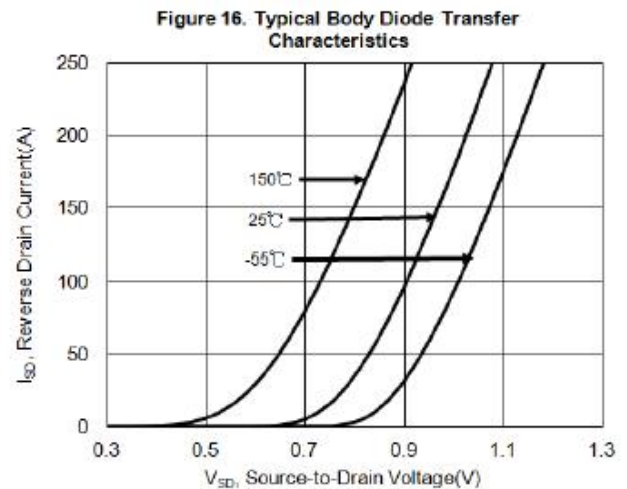
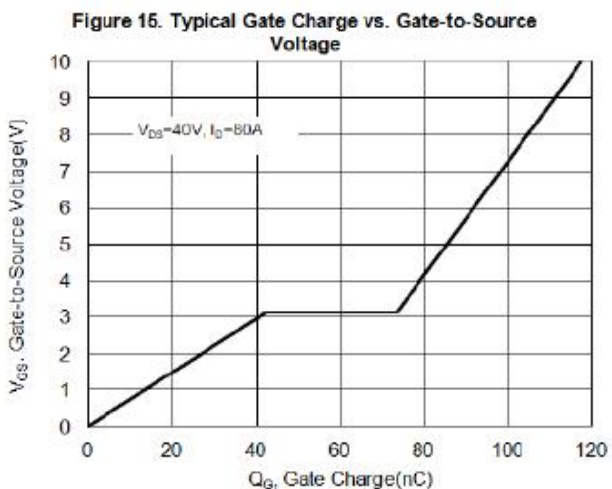
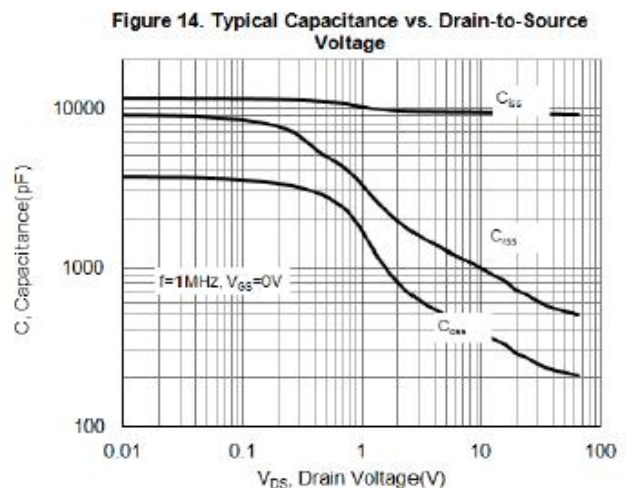
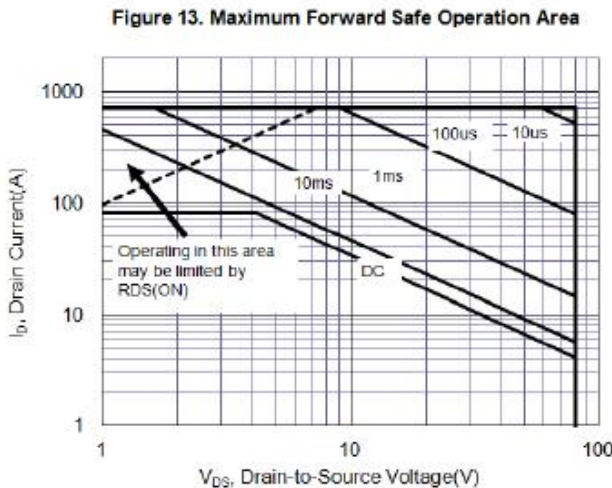
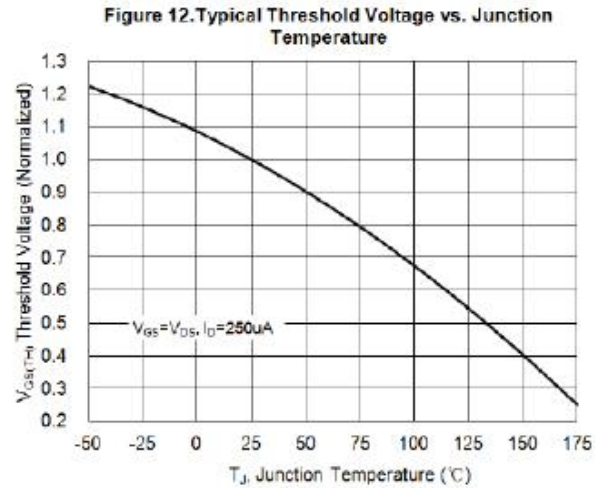
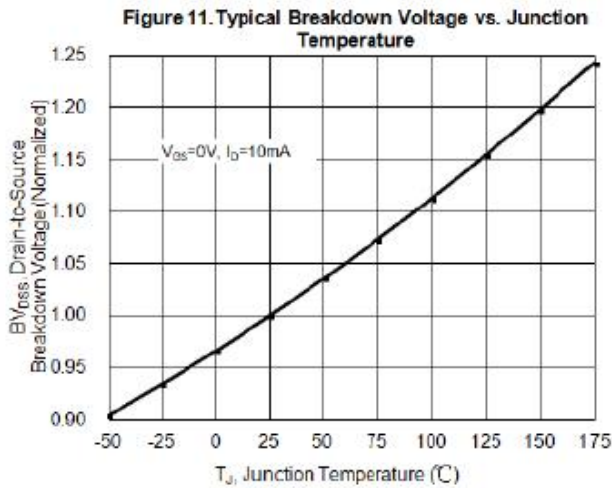


**Figure 9. Typical Drain-to-Source ON Resistance**



**Figure 10. Typical Drain-to-Source On Resistance vs. Junction Temperature**





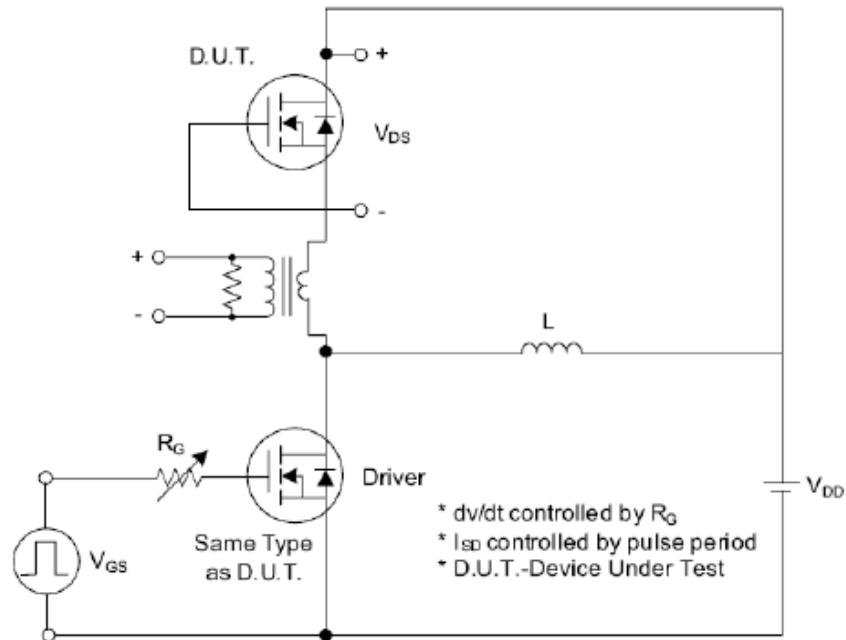


Fig. 1.1 Peak Diode Recovery  $dv/dt$  Test Circuit

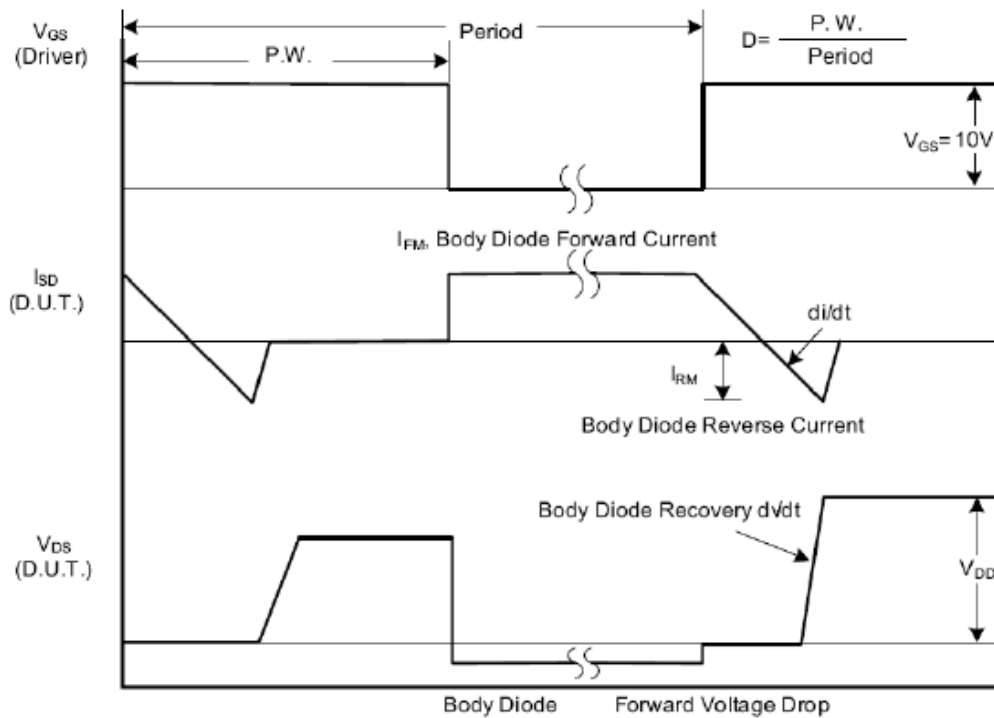


Fig. 1.2 Peak Diode Recovery  $dv/dt$  Waveforms

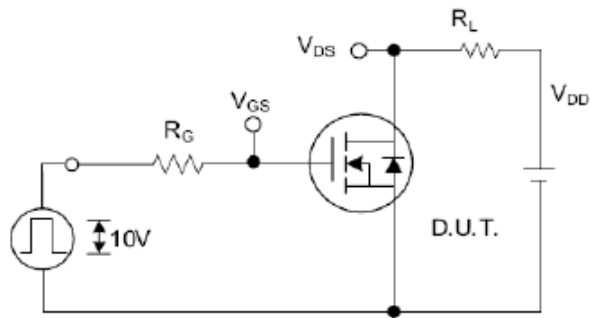


Fig. 2.1 Switching Test Circuit

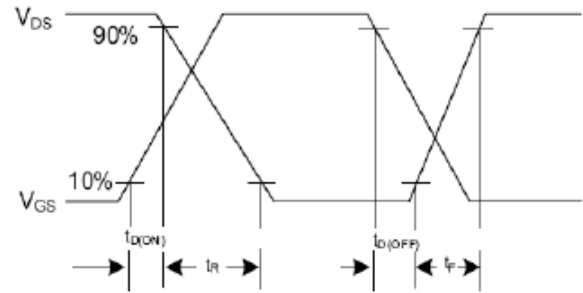


Fig. 2.2 Switching Waveforms

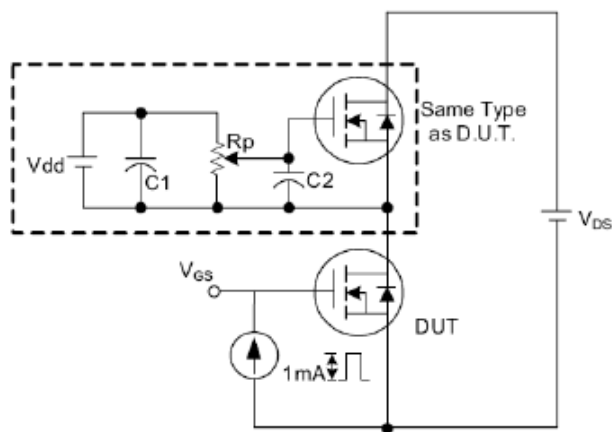


Fig. 3.1 Gate Charge Test Circuit

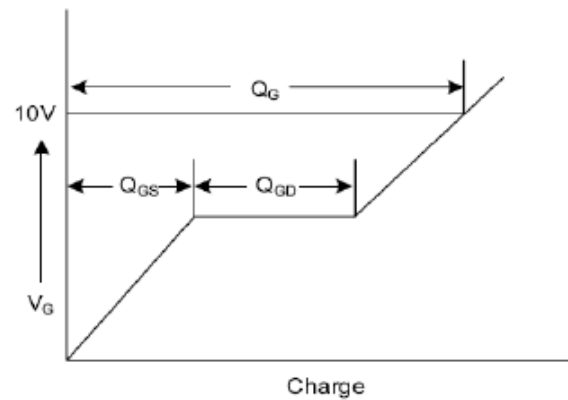


Fig. 3.2 Gate Charge Waveform

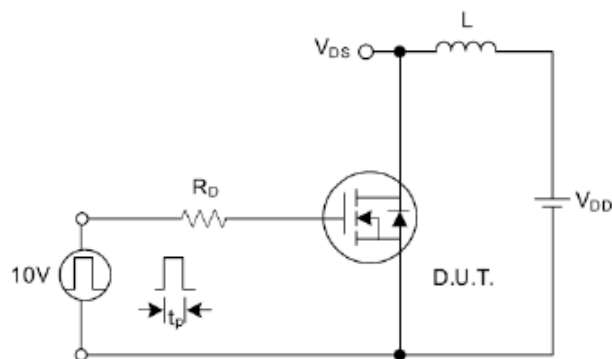


Fig. 4.1 Unclamped Inductive Switching Test Circuit

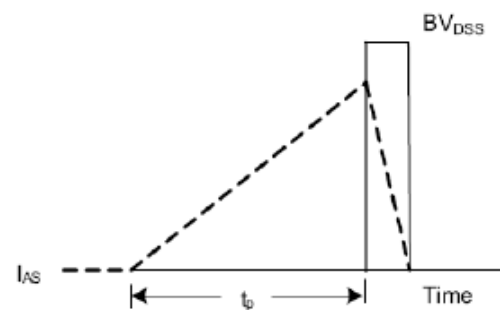


Fig. 4.2 Unclamped Inductive Switching Waveforms



## X-ON Electronics

Largest Supplier of Electrical and Electronic Components

*Click to view similar products for [MOSFET](#) category:*

*Click to view products by [KIA](#) manufacturer:*

Other Similar products are found below :

[IRFD120](#) [JANTX2N5237](#) [BUK455-60A/B](#) [MIC4420CM-TR](#) [VN1206L](#) [NDP4060](#) [SI4482DY](#) [IPS70R2K0CEAKMA1](#) [SQD23N06-31L-GE3](#)  
[TK16J60W,S1VQ\(O](#) [2SK2614\(TE16L1,Q\)](#) [DMN1017UCP3-7](#) [DMN1053UCP4-7](#) [SQJ469EP-T1-GE3](#) [NTE2384](#) [DMC2700UDMQ-7](#)  
[DMN2080UCB4-7](#) [DMN61D9UWQ-13](#) [US6M2GTR](#) [DMN31D5UDJ-7](#) [DMP22D4UFO-7B](#) [DMN1006UCA6-7](#) [DMN16M9UCA6-7](#)  
[STF5N65M6](#) [IRF40H233XTMA1](#) [STU5N65M6](#) [DMN6022SSD-13](#) [DMN13M9UCA6-7](#) [DMTH10H4M6SPS-13](#) [DMN2990UFB-7B](#)  
[IPB80P04P405ATMA2](#) [2N7002W-G](#) [MCAC30N06Y-TP](#) [MCQ7328-TP](#) [BXP7N65D](#) [BXP4N65F](#) [AOL1454G](#) [WMJ80N60C4](#) [BXP2N20L](#)  
[BXP2N65D](#) [BXT1150N10J](#) [BXT1700P06M](#) [TSM60NB380CP](#) [ROG](#) [RQ7L055BGTCR](#) [DMNH15H110SK3-13](#) [SLF10N65ABV2](#)  
[BSO203SP](#) [BSO211P](#) [IPA60R230P6](#) [IPA60R460CE](#)