

Part Number: AA3528SURSK

Hyper Red

Features

- Single color.
- Suitable for all SMT assembly and solder process.
- Available on tape and reel.
- Ideal for backlighting.
- Package : 2000pcs / reel.
- Moisture sensitivity level : level 3.
- RoHS compliant.

Description

The Hyper Red source color devices are made with AlGaInP on GaAs substrate Light Emitting Diode.

Package Dimensions

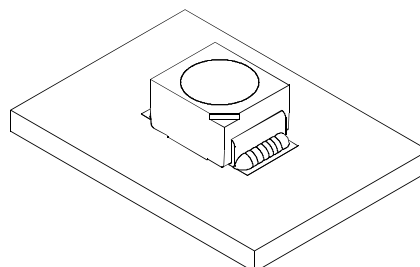
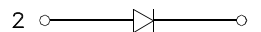
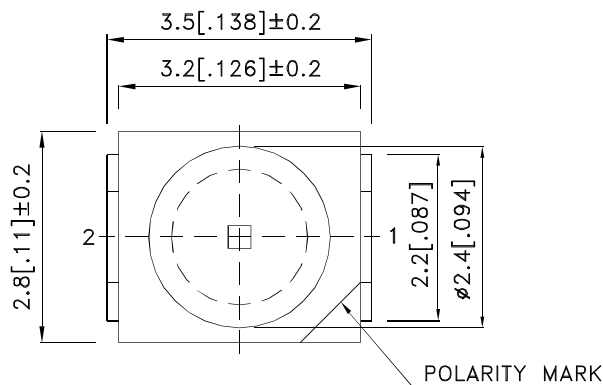

Notes:

1. All dimensions are in millimeters (inches).
2. Tolerance is ±0.25(0.01") unless otherwise noted.
3. The specifications, characteristics and technical data described in the datasheet are subject to change without prior notice.
4. The device has a single mounting surface. The device must be mounted according to the specifications.



Handling Precautions

Compare to epoxy encapsulant that is hard and brittle, silicone is softer and flexible. Although its characteristic significantly reduces thermal stress, it is more susceptible to damage by external mechanical force.

As a result, special handling precautions need to be observed during assembly using silicone encapsulated LED products. Failure to comply might lead to damage and premature failure of the LED.

1. Handle the component along the side surfaces by using forceps or appropriate tools.

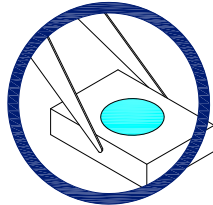

2. Do not directly touch or handle the silicone lens surface. It may damage the internal circuitry.



3. Do not stack together assembled PCBs containing exposed LEDs. Impact may scratch the silicone lens or damage the internal circuitry.

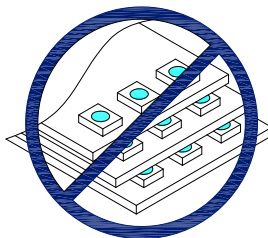

- 4.1. The inner diameter of the SMD pickup nozzle should not exceed the size of the LED to prevent air leaks.
- 4.2. A pliable material is suggested for the nozzle tip to avoid scratching or damaging the LED surface during pickup.
- 4.3. The dimensions of the component must be accurately programmed in the pick-and-place machine to insure precise pickup and avoid damage during production.



5. As silicone encapsulation is permeable to gases, some corrosive substances such as H_2S might corrode silver plating of leadframe. Special care should be taken if an LED with silicone encapsulation is to be used near such substances.

All design applications should refer to Kingbright application notes available at <http://www.KingbrightUSA.com/ApplicationNotes>

Selection Guide

Part No.	Dice	Lens Type	Iv (mcd) [2] @ 20mA		Viewing Angle [1]
			Min.	Typ.	2θ1/2
AA3528SURSK	Hyper Red (AlGaInP)	Water Clear	150	350	120°
			*55	*100	

Notes:

1. θ1/2 is the angle from optical centerline where the luminous intensity is 1/2 of the optical peak value.
 2. Luminous intensity/ luminous Flux: +/-15%.
- * Luminous intensity value is traceable to the CIE127-2007 compliant national standards.

Electrical / Optical Characteristics at TA=25°C

Symbol	Parameter	Device	Typ.		Max.	Units	Test Conditions
λpeak	Peak Wavelength	Hyper Red	650	*645		nm	IF=20mA
λD [1]	Dominant Wavelength	Hyper Red	630	*630		nm	IF=20mA
Δλ1/2	Spectral Line Half-width	Hyper Red	28			nm	IF=20mA
C	Capacitance	Hyper Red	35			pF	VF=0V;f=1MHz
VF [2]	Forward Voltage	Hyper Red	1.95		2.5	V	IF=20mA
IR	Reverse Current	Hyper Red			10	uA	VR=5V

Notes:

1. Wavelength: +/-1nm.
 2. Forward Voltage: +/-0.1V.
- * Wavelength value is traceable to the CIE127-2007 compliant national standards.

Absolute Maximum Ratings at TA=25°C

Parameter	Hyper Red	Units
Power dissipation	75	mW
DC Forward Current	30	mA
Peak Forward Current [1]	185	mA
Reverse Voltage	5	V
Operating Temperature	-40°C To +85°C	
Storage Temperature	-40°C To +85°C	

Note:

1. 1/10 Duty Cycle, 0.1ms Pulse Width.

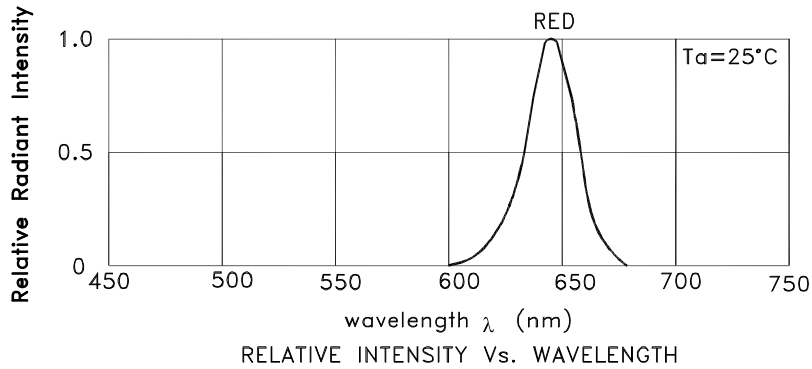

Hyper Red

AA3528SURSK

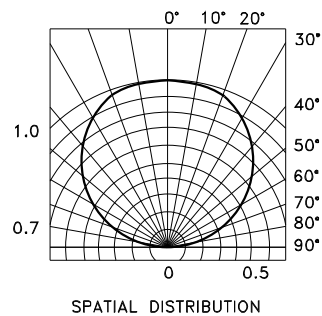
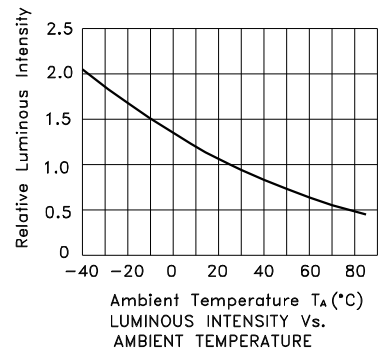
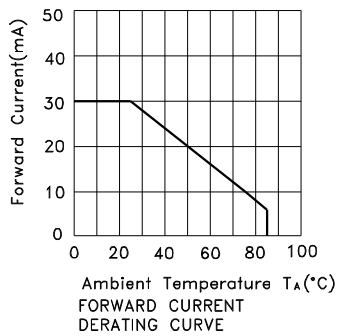
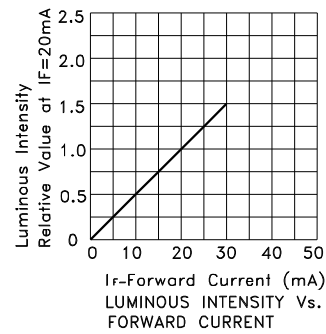
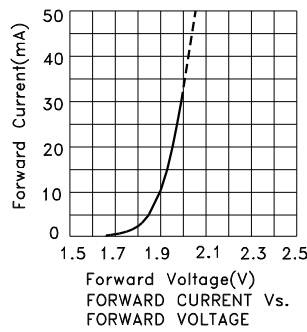

Kingbright

PACKING & LABEL SPECIFICATIONS

AA3528SURSK

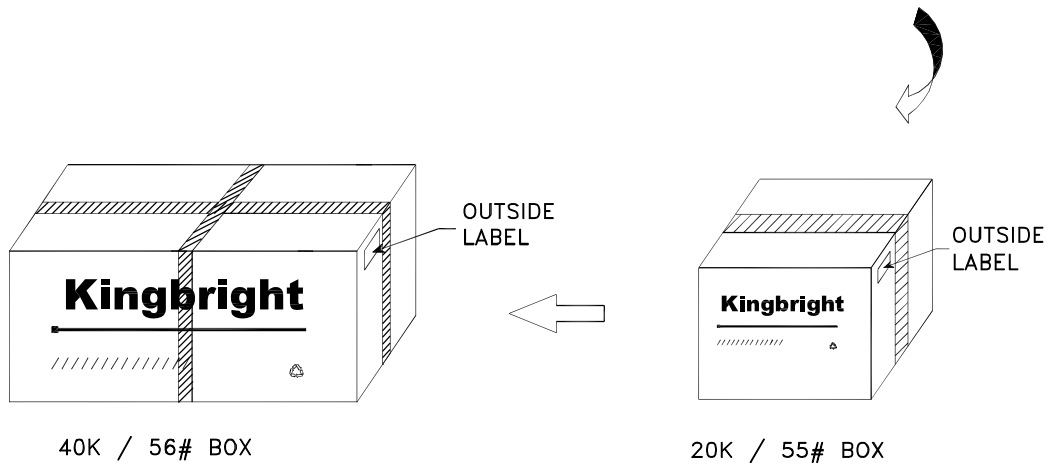
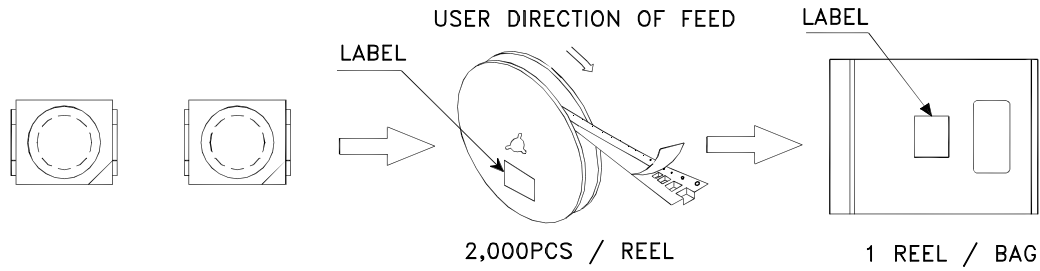

<h1>Kingbright</h1>	
P/NO: AA3528xxx	
QTY: 2,000 pcs	Q.C. Q C XX XX XXXX PASSED
S/N: XXXX	
CODE: XXX	
LOT NO:	
 <small>XXXXXXXXXXXXXXXXXXXXXXXXXXXX</small>	
RoHS Compliant	

X-ON Electronics

Largest Supplier of Electrical and Electronic Components

Click to view similar products for [Standard LEDs - SMD category](#):

Click to view products by [Kingbright manufacturer](#):

Other Similar products are found below :

[LTST-C190KYKT](#) [LTST-C19GD2WT](#) [LTST-N683GBEW](#) [LTW-170ZDC](#) [LTW-M140SZS40](#) [598-8110-100F](#) [598-8170-100F](#) [598-8610-202F](#) [67-22VRVGC/TR8](#) [AAAF5060QBFSEEZGS](#) [HLMA-QG00-S0021](#) [HLMP-6305-L0011](#) [ALMD-LB36-SV002](#) [APT1608QGW](#) [15-21UYC/S530-A3/TR8](#) [EAST2012YA0](#) [EASV1803BA0](#) [LG M67K-H1J2-24-0-2-R18-Z](#) [LS A676-P2S1-1](#) [SML310BATT86](#) [SML-LX0606SISUGC/A](#) [SML-LXL1307SRC-TR](#) [SML-LXR851SIUPGUBC](#) [LT1ED53A](#) [FAT801-S](#) [AM27ZGC03](#) [APB3025SGNC](#) [APFA3010SURKCGKQBDC](#) [APHK1608VGCA](#) [APT2012QGW](#) [LTST-C250KGKT](#) [LTW-010DCG](#) [LTW-020ZDCG](#) [LTW-21TS5](#) [LTW-220DS5](#) [LY L29K-H1J2-26](#) [UYGT801-S](#) [42-21UYC/S530-A3/TR8](#) [LO T67F-V1AB-24-1](#) [YGFR411-H](#) [598-8330-117F](#) [SML-LX0402IC-TR](#) [CMDA20AYAA7D1S](#) [CMDA16AYDR7A1X](#) [598-8040-100F](#) [598-8070-100F](#) [598-8140-100F](#) [598-8610-200F](#) [EAST2012GA0](#) [EAPL3527GA5](#)