



ATTENTION
OBSERVE PRECAUTIONS
FOR HANDLING
ELECTROSTATIC
DISCHARGE
SENSITIVE
DEVICES

Part Number: AAAF5051-04

Blue
Reddish-Orange
Green

Features

- Chips can be controlled separately.
- Suitable for all SMT assembly and solder process.
- Available on tape and reel.
- White SMD package, silicone resin.
- Package: 500pcs / reel.
- Moisture sensitivity level : level 3.
- RoHS compliant.

Descriptions

- The Blue source color devices are made with InGaN on Al₂O₃ substrate Light Emitting Diode.
- The Reddish-Orange source color devices are made with AlGaInP on AlN substrate Light Emitting Diode.
- The Green source color devices are made with InGaN on Al₂O₃ substrate Light Emitting Diode.
- Electrostatic discharge and power surge could damage the LEDs.
- It is recommended to use a wrist band or anti-electrostatic glove when handling the LEDs.
- All devices, equipments and machineries must be electrically grounded.

Package Dimensions

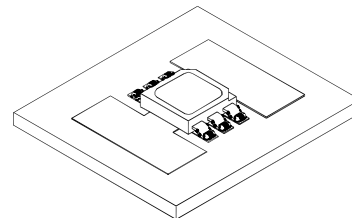
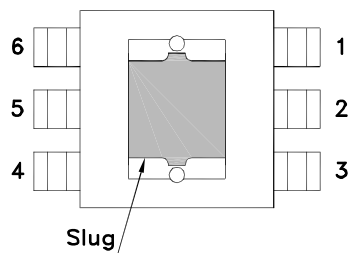
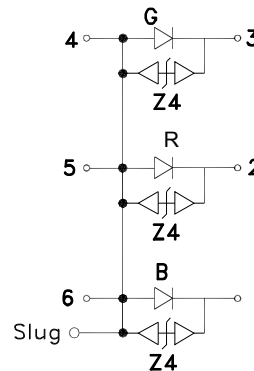
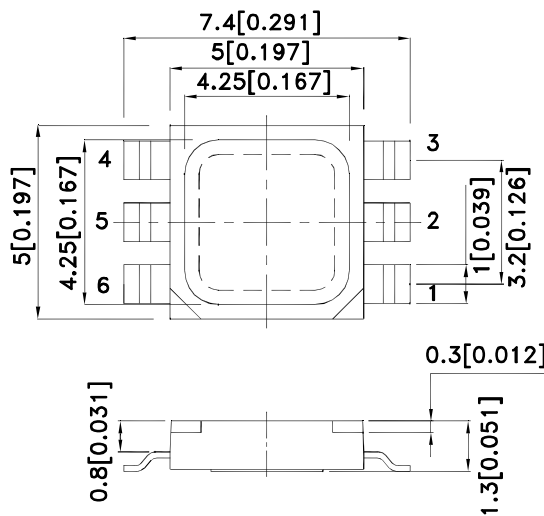

Notes:

1. All dimensions are in millimeters (inches).
2. Tolerance is $\pm 0.15 [\pm 0.006]$ unless otherwise noted.
3. The specifications, characteristics and technical data described in the datasheet are subject to change without prior notice.
4. The device has a single mounting surface. The device must be mounted according to the specifications.



Handling Precautions

Compare to epoxy encapsulant that is hard and brittle, silicone is softer and flexible. Although its characteristic significantly reduces thermal stress, it is more susceptible to damage by external mechanical force.

As a result, special handling precautions need to be observed during assembly using silicone encapsulated LED products. Failure to comply might lead to damage and premature failure of the LED.

1. Handle the component along the side surfaces by using forceps or appropriate tools.

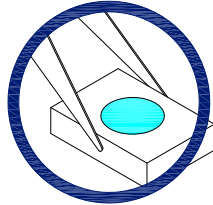

2. Do not directly touch or handle the silicone lens surface. It may damage the internal circuitry.

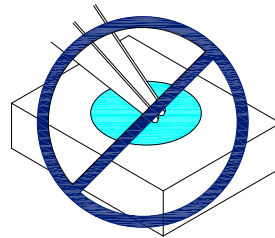
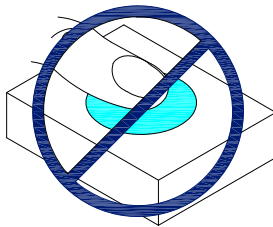

3. Do not stack together assembled PCBs containing exposed LEDs. Impact may scratch the silicone lens or damage the internal circuitry.

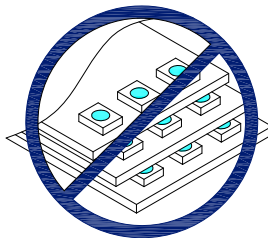

- 4.1. The inner diameter of the SMD pickup nozzle should not exceed the size of the LED to prevent air leaks.
- 4.2. A pliable material is suggested for the nozzle tip to avoid scratching or damaging the LED surface during pickup.
- 4.3. The dimensions of the component must be accurately programmed in the pick-and-place machine to insure precise pickup and avoid damage during production.

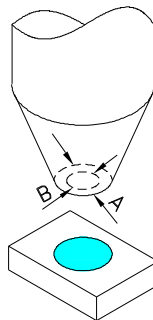

5. As silicone encapsulation is permeable to gases, some corrosive substances such as H₂S might corrode silver plating of leadframe. Special care should be taken if an LED with silicone encapsulation is to be used near such substances.

Selection Guide

Part No.	Dice	Lens Type	Iv (mcd) [2] @ 150mA		Φv (lm) [2] @ 150mA*		Viewing Angle [1]
			Min.	Typ.	Min.	Typ.	2θ1/2
AAAF5051-04	Blue (InGaN)	Water Clear	1000	1500	4.2	6	120°
	Reddish-Orange (AlGaInP)		2700	3200	10	12	
	Green (InGaN)		5000	6300	17	20	

Notes:

1. θ1/2 is the angle from optical centerline where the luminous intensity is 1/2 of the optical peak value.
2. Luminous intensity/ luminous Flux: +/-15%. *LEDs are binned according to their luminous flux.
3. Luminous intensity/ luminous Flux value is traceable to the CIE127-2007 compliant national standards.

Absolute Maximum Ratings at Ta=25°C

Parameter	Symbol	Device	Value	Unit	Test Conditions
Power dissipation	Pd	Blue	0.6	W	If=150mA If=150mA If=150mA
		Reddish-Orange	0.45		
		Green	0.6		
Junction temperature	Tj	Blue	110	°C	If=150mA If=150mA If=150mA
		Reddish-Orange	110		
		Green	110		
Operating Temperature	Top	Blue	-40 To +85	°C	If=150mA If=150mA If=150mA
		Reddish-Orange			
		Green			
Storage Temperature	Tstg	Blue	-40 To +85	°C	If=150mA If=150mA If=150mA
		Reddish-Orange			
		Green			
DC Forward Current [1]	If	Blue	150	mA	If=150mA If=150mA If=150mA
		Reddish-Orange	150		
		Green	150		
Peak Forward Current [2]	IfM	Blue	300	mA	If=150mA If=150mA If=150mA
		Reddish-Orange	300		
		Green	300		
Thermal resistance	Rth j-a	Blue	220	°C/W	If=150mA If=150mA If=150mA
		Reddish-Orange	270		
		Green	200		
Thermal resistance	Rth j-s	Blue	25	°C/W	If=150mA If=150mA If=150mA
		Reddish-Orange	40		
		Green	33		
Reverse Current	IR	Blue	10	uA	VR=5V
		Reddish-Orange	10		
		Green	10		

Notes:

1. Results from mounting on Aluminum Board.
2. 1/10 Duty Cycle, 0.1ms Pulse Width.

Electrical / Optical Characteristics at T_a=25°C

Parameter	Symbol	Device	Value			Unit
			Min.	Typ.	Max.	
Wavelength at peak emission I _F =150mA	λ peak	Blue		452		nm
Wavelength at peak emission I _F =150mA		Reddish-Orange		635		
Wavelength at peak emission I _F =150mA		Green		515		
Dominant Wavelength I _F =150mA	λ dom [1]	Blue		460		nm
Dominant Wavelength I _F =150mA		Reddish-Orange		624		
Dominant Wavelength I _F =150mA		Green		525		
Spectral Line Half-width I _F =150mA	Δλ1/2	Blue		25		nm
Spectral Line Half-width I _F =150mA		Reddish-Orange		20		
Spectral Line Half-width I _F =150mA		Green		30		
Forward Voltage I _F =150mA	V _F [2]	Blue	3.0	3.5	4.0	V
Forward Voltage I _F =150mA		Reddish-Orange	2.0	2.5	3.0	
Forward Voltage I _F =150mA		Green	3.0	3.5	4.0	
Reverse Voltage	V _R	Blue		5		V
		Reddish-Orange		5		
		Green		5		
Temperature coefficient of λ peak I _F =150mA, -10 ° C ≤ T ≤ 100 ° C	TC λ peak	Blue		0.12		nm/° C
Temperature coefficient of λ peak I _F =150mA, -10 ° C ≤ T ≤ 100 ° C		Reddish-Orange		0.09		
Temperature coefficient of λ peak I _F =150mA, -10 ° C ≤ T ≤ 100 ° C		Green		0.13		
Temperature coefficient of λ dom I _F =150mA, -10 ° C ≤ T ≤ 100 ° C	TC λ dom	Blue		0.1		nm/° C
Temperature coefficient of λ dom I _F =150mA, -10 ° C ≤ T ≤ 100 ° C		Reddish-Orange		0.03		
Temperature coefficient of λ dom I _F =150mA, -10 ° C ≤ T ≤ 100 ° C		Green		0.11		
Temperature coefficient of V _F I _F =150mA, -10 ° C ≤ T ≤ 100 ° C	TC _V	Blue		-2.3		mV/° C
Temperature coefficient of V _F I _F =150mA, -10 ° C ≤ T ≤ 100 ° C		Reddish-Orange		-2.7		
Temperature coefficient of V _F I _F =150mA, -10 ° C ≤ T ≤ 100 ° C		Green		-3.9		

Notes:

- 1.Wavelength: +/-1nm.
- 2.Forward Voltage: +/-0.2V.
- 3.Wavelength value is traceable to the CIE127-2007 compliant national standards.
- 4.Excess driving current and/or operating temperature higher than recommended conditions may result in severe light degradation or premature failure.

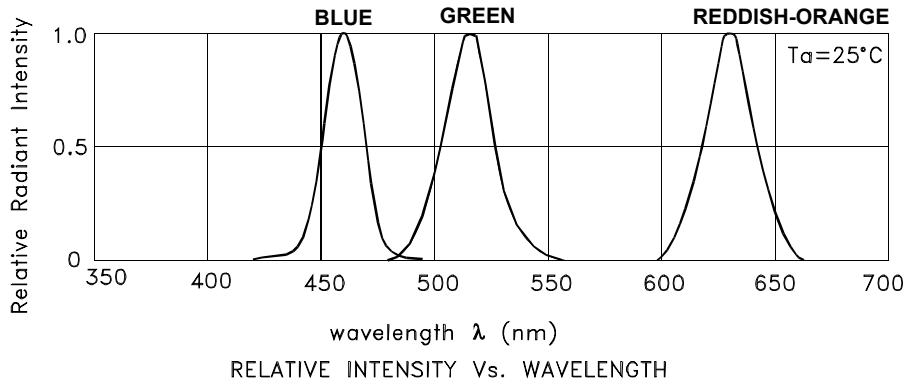

AAAF5051-04
Blue

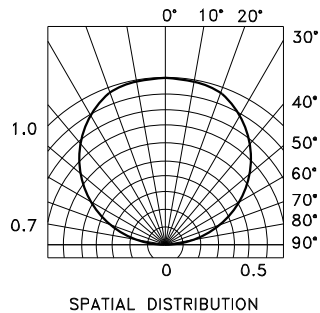
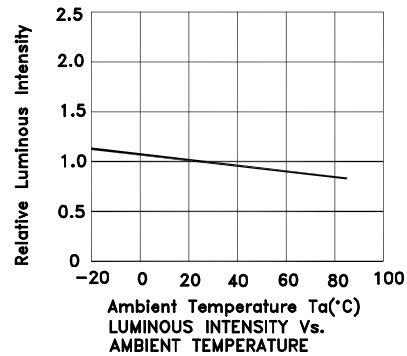
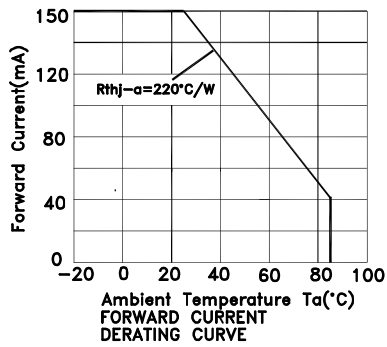
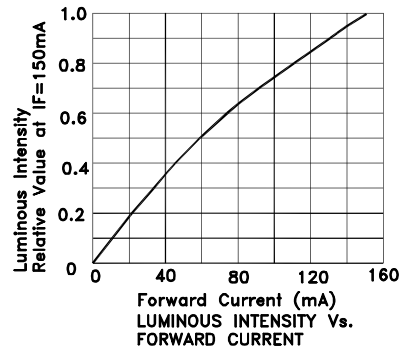
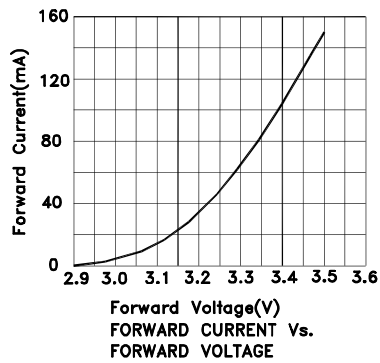

Reddish-orange

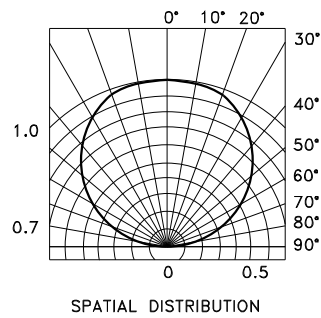
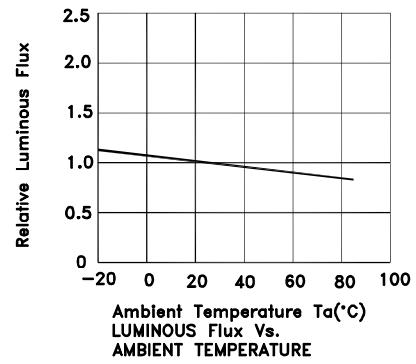
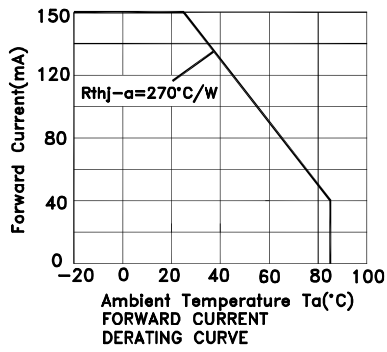
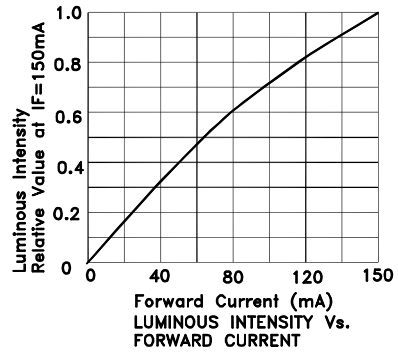
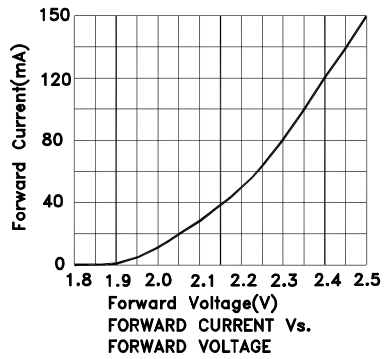

Green

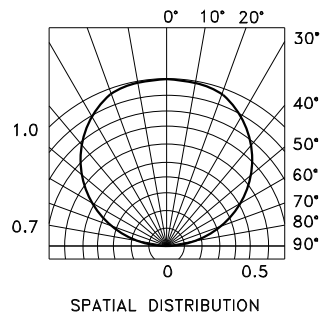
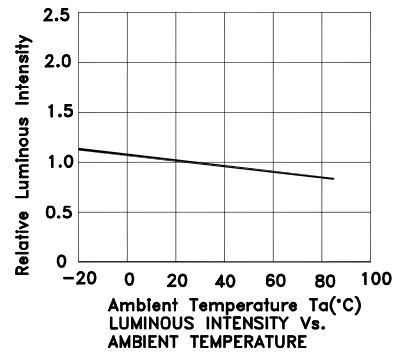
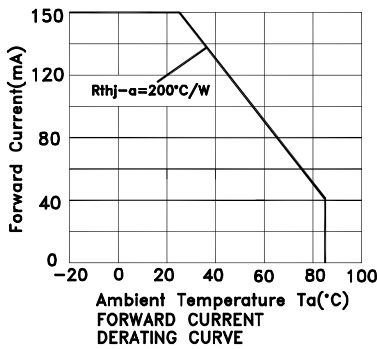
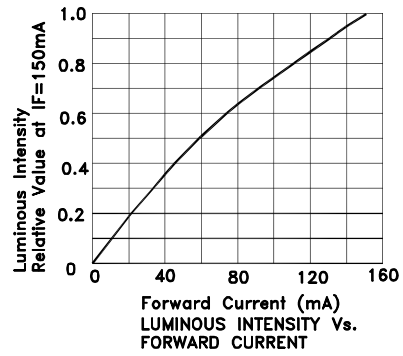
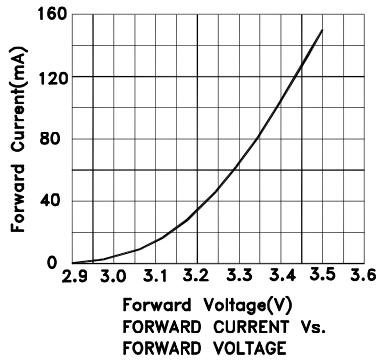

AAAF5051-04

Reflow soldering is recommended and the soldering profile is shown below.
Other soldering methods are not recommended as they might cause damage to the product.

Reflow Soldering Profile For Lead-free SMT Process.

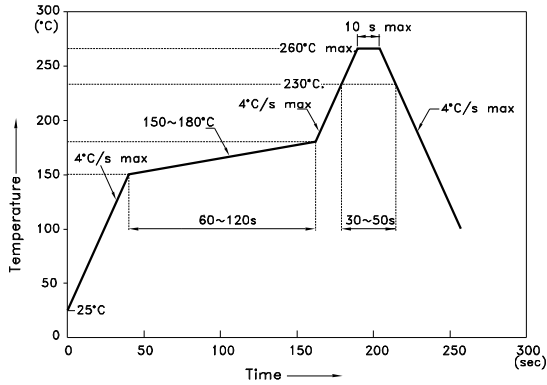

- NOTES:
1. We recommend the reflow temperature 245°C(+/-5°C). The maximum soldering temperature should be limited to 260°C.
 2. Don't cause stress to the epoxy resin while it is exposed to high temperature.
 3. Number of reflow process shall be 2 times or less.

Reel Dimension

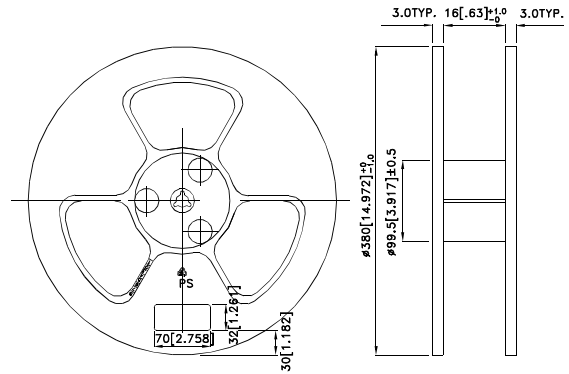

Recommended Soldering Pattern (Units : mm; Tolerance: ± 0.1)

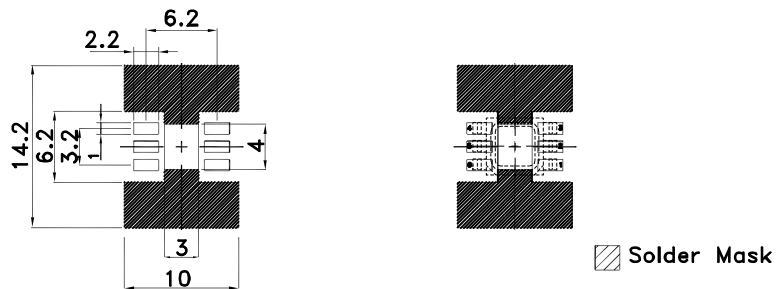

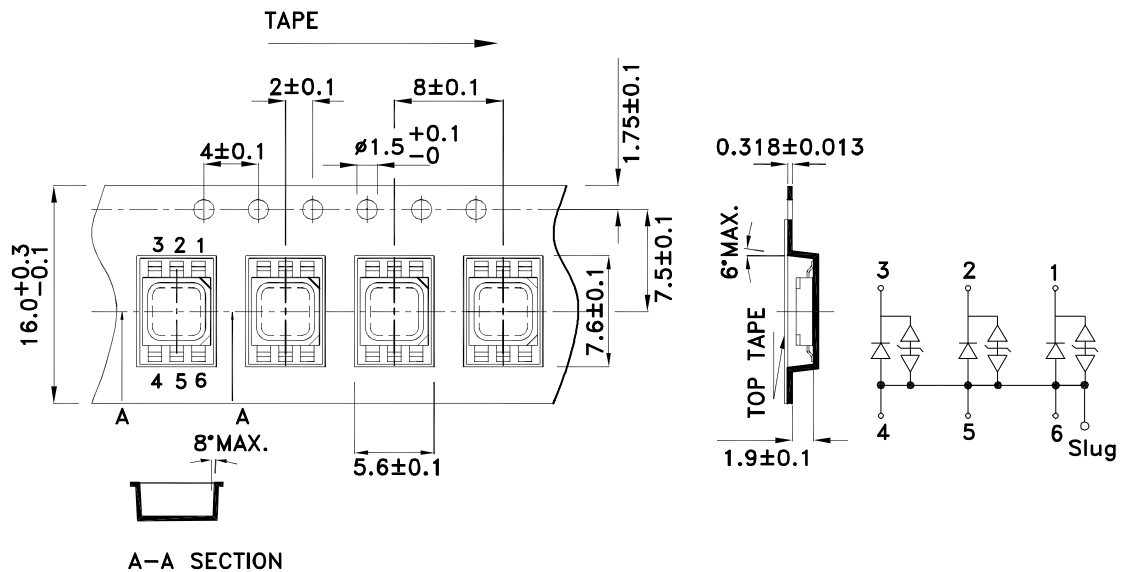

Tape Specifications (Units : mm)

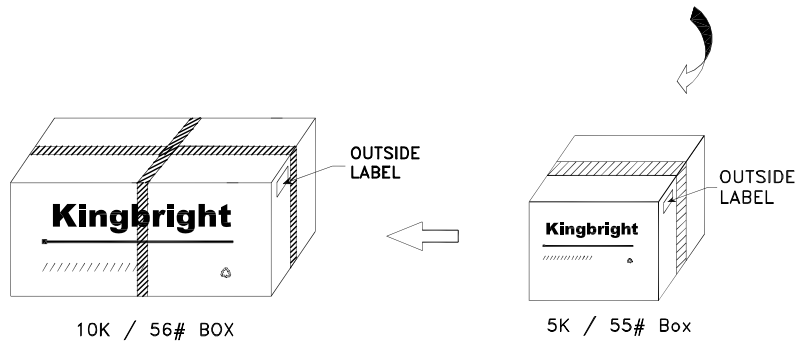
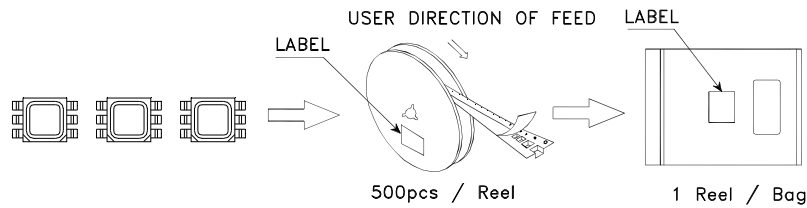

PACKING & LABEL SPECIFICATIONS

AAAF5051-04



Kingbright	
P/N0: AAAF5051xxx	
QTY: 500 pcs	Q.C. Q C xx xx xxxx PASSED
S/N: XXXX	
CODE: XXX	
LOT NO:	
 xxxxxxxxxxxxxxxxxxxxxx	
RoHS Compliant	

Terms and conditions for the usage of this document

- 1.The information included in this document reflects representative usage scenarios and is intended for technical reference only.
- 2.The part number, type, and specifications mentioned in this document are subject to future change and improvement without notice. Before production usage customer should refer to the latest datasheet for the updated specifications.
- 3.When using the products referenced in this document, please make sure the product is being operated within the environmental and electrical limits specified in the datasheet. If customer usage exceeds the specified limits, Kingbright will not be responsible for any subsequent issues.
- 4.The information in this document applies to typical usage in consumer electronics applications. If customer's application has special reliability requirements or have life-threatening liabilities, such as automotive or medical usage, please consult with Kingbright representative for further assistance.
- 5.The contents and information of this document may not be reproduced or re-transmitted without permission by Kingbright.
- 6.All design applications should refer to Kingbright application notes available at <http://www.KingbrightUSA.com/ApplicationNotes>

X-ON Electronics

Largest Supplier of Electrical and Electronic Components

Click to view similar products for [High Power LEDs - Multi-Colour category](#):

Click to view products by [Kingbright manufacturer](#):

Other Similar products are found below :

[11-22/R8G6C-A30/2T](#) [LL-HP60NUYC](#) [OSB5XZE1E1E](#) [OSG5XDE5E1E](#) [OSR5XAE1E1E](#) [OSR5XAE3E1E](#) [OSR5XME1E1E](#)
[OSY5XAE1E1E](#) [OSY5XDE5E1E](#) [PC8N-5LTS-C](#) [PK2N-3LAE-SD](#) [PK2N-3LGE-SD](#) [PK2N-3LRE-SD](#) [PM2B-3LGS-SD](#) [PQ2A-4FGE](#)
[PQ2A-4FPE-YGFC](#) [PM2E-1LAS](#) [PM2E-1LGS](#) [PM2E-1LRS](#) [PM2E-3LAE-SD](#) [PM2E-3LAS-SD](#) [PM2E-3LBS-SD](#) [PM2E-3LGS-SD](#) [PM2E-](#)
[3LRE-SD](#) [PM2E-3LRS-SD](#) [PP6N-TFFE-D60](#) [PP6N-3LFE](#) [PP6N-1LFE-P](#) [PK2N-3LLE-L](#) [OSB4XDE5E1E](#) [OSG5XME1E1E](#)
[OSR5XAT1C1E](#) [OSR5XAT3C1E](#) [OSR5XDE5E1E](#) [OSY5XAE3E1E](#) [OSY5XAT3C1E](#) [OSY5XME3E1E](#) [PC8N-5L4E-C](#) [PK2N-3LBE-SD](#)
[PM2B-1LPE-M](#) [PM2B-1LPS-M](#) [PQ2A-4FBE](#) [PQ2A-4FRE](#) [AAAF5051-05](#) [L1MC-RGB3080500MP0](#) [SBM-40-RGBW-SC41-QD100](#)
[OSB5XZE3E1E](#) [OSG5XME3E1E](#) [OSG5XZE3E1E](#) [OSY5XME1E1E](#)