



APGF0808VGTPBTSEETC

0.8 x 0.8 x 0.2 mm Full-Color Surface Mount LED

DESCRIPTIONS

- The Green source color devices are made with InGaN on SiC substrate Light Emitting Diode
- The Blue source color devices are made with InGaN on SiC substrate Light Emitting Diode
- The Hyper Red source color devices are made with AlGaInP on GaAs substrate Light Emitting Diode
- Electrostatic discharge and power surge could Damage the LEDs
- It is recommended to use a wrist band or anti-electrostatic glove when handling the LEDs
- All devices, equipments and machineries must be electrically grounded

FEATURES

- 0.8 mm x 0.8 mm SMD LED, 0.2 mm thickness
- Low power consumption
- Can produce any color in visible spectrum
- Package: 4000 pcs / reel
- Moisture sensitivity level: 3
- RoHS compliant

APPLICATIONS

- Backlight
- Status indicator
- Home and smart appliances
- Wearable and portable devices
- Healthcare applications

ATTENTION

Observe precautions for handling electrostatic discharge sensitive devices



PACKAGE DIMENSIONS

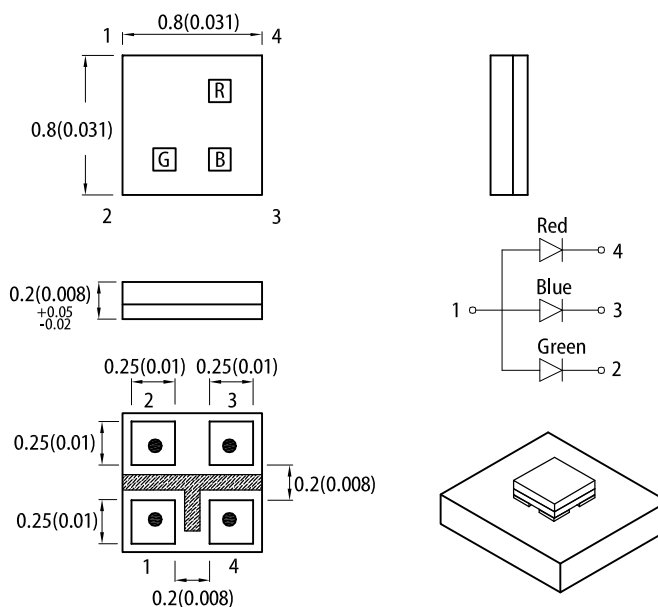

RECOMMENDED SOLDERING PATTERN

(units : mm; tolerance : ± 0.1)

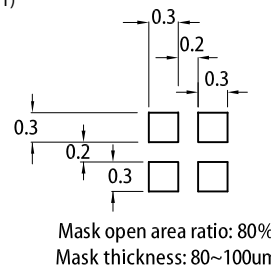

Notes:

1. All dimensions are in millimeters (inches).
2. Tolerance is ±0.1(0.004") unless otherwise noted.
3. The specifications, characteristics and technical data described in the datasheet are subject to change without prior notice.
4. The device has a single mounting surface. The device must be mounted according to the specifications.

SELECTION GUIDE

Part Number	Emitting Color (Material)	Lens Type	Iv (mcd) @ 5mA ^[2]		Viewing Angle ^[1]
			Min.	Typ.	2θ1/2
APGF0808VGTPBTSEETC	Green (InGaN)	Water Clear	30	90	150°
	Blue (InGaN)		5	20	150°
	Hyper Red (AlGaInP)		10	30	130°

Notes:

1. θ1/2 is the angle from optical centerline where the luminous intensity is 1/2 of the optical peak value.
2. Luminous intensity / luminous flux: +/-15%.
3. Luminous intensity value is traceable to CIE127-2007 standards.

ELECTRICAL / OPTICAL CHARACTERISTICS at $T_A=25^\circ\text{C}$

Parameter	Symbol	Emitting Color	Value		Unit
			Typ.	Max.	
Wavelength at Peak Emission $I_F = 5\text{mA}$	λ_{peak}	Green Blue Hyper Red	518 461 632	-	nm
Dominant Wavelength $I_F = 5\text{mA}$	$\lambda_{\text{dom}}^{[1]}$	Green Blue Hyper Red	527 467 624	-	nm
Spectral Bandwidth at 50% Φ REL MAX $I_F = 5\text{mA}$	$\Delta\lambda$	Green Blue Hyper Red	35 22 20	-	nm
Capacitance	C	Green Blue Hyper Red	100 110 25	-	pF
Forward Voltage $I_F = 5\text{mA}$	$V_F^{[2]}$	Green Blue Hyper Red	3 2.9 1.95	3.2 3.1 2.3	V
Reverse Current ($V_R = 5\text{V}$)	I_R	Green Blue Hyper Red	-	50 50 10	μA
Temperature Coefficient of λ_{peak} $I_F = 5\text{mA}$, $-10^\circ\text{C} \leq T \leq 85^\circ\text{C}$	$\text{TC}_{\lambda_{\text{peak}}}$	Green Blue Hyper Red	0.05 0.04 0.13	-	$\text{nm}/^\circ\text{C}$
Temperature Coefficient of λ_{dom} $I_F = 5\text{mA}$, $-10^\circ\text{C} \leq T \leq 85^\circ\text{C}$	$\text{TC}_{\lambda_{\text{dom}}}$	Green Blue Hyper Red	0.03 0.03 0.06	-	$\text{nm}/^\circ\text{C}$
Temperature Coefficient of V_F $I_F = 5\text{mA}$, $-10^\circ\text{C} \leq T \leq 85^\circ\text{C}$	TC_V	Green Blue Hyper Red	-3.0 -3.0 -1.9	-	$\text{mV}/^\circ\text{C}$

Notes:

- The dominant wavelength (λ_d) above is the setup value of the sorting machine. (Tolerance $\lambda_d: \pm 1\text{nm}$.)
- Forward voltage: $\pm 0.1\text{V}$.
- Wavelength value is traceable to CIE127-2007 standards.
- Excess driving current and / or operating temperature higher than recommended conditions may result in severe light degradation or premature failure.

ABSOLUTE MAXIMUM RATINGS at $T_A=25^\circ\text{C}$

Parameter	Symbol	Value			Unit
		Green	Blue	Hyper Red	
Power Dissipation	$P_D^{[1]}$	35			mW
Reverse Voltage	V_R	5	5	5	V
Junction Temperature	T_j	125	125	115	$^\circ\text{C}$
Operating Temperature	T_{op}	-40 to +85			$^\circ\text{C}$
Storage Temperature	T_{stg}	-40 to +100			$^\circ\text{C}$
DC Forward Current	$I_F^{[2]}$	10	10	10	mA
Peak Forward Current	$I_{\text{FM}}^{[3]}$	50	50	50	mA
Electrostatic Discharge Threshold (HBM)	-	1000	1000	3000	V
Thermal Resistance (Junction / Ambient)	$R_{\text{th JA}}^{[4]}$	660	365	580	$^\circ\text{C}/\text{W}$
Thermal Resistance (Junction / Solder point)	$R_{\text{th JS}}^{[4]}$	535	260	500	$^\circ\text{C}/\text{W}$

Notes:

- Within 35mW when multiple chips are lightened
- The maximum ratings are valid for the case of lighting a single chip
When two chips are lit at the same time, each chip should be driven at a current lower than 50% of the absolute maximum ratings
When three chips are lit at the same time, each chip should be driven at a current lower than 30% of the absolute maximum ratings
- Duty Cycle $\leq 1/20$, Pulse Width = 1ms.
- $R_{\text{th JA}}$, $R_{\text{th JS}}$ Results from mounting on PC board FR4 (pad size $\geq 16\text{mm}^2$ per pad).
- Relative humidity levels maintained between 40% and 60% in production area are recommended to avoid the build-up of static electricity – Ref JEDEC/JESD625-A and JEDEC/J-STD-033.

TECHNICAL DATA

RELATIVE INTENSITY vs. WAVELENGTH

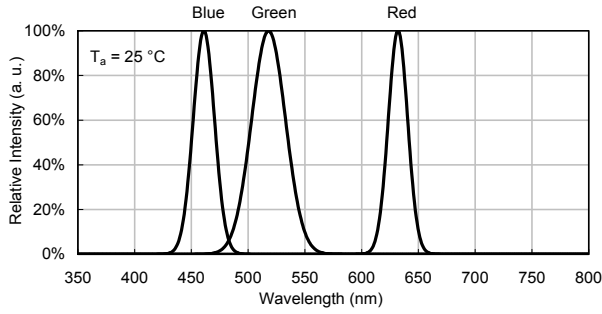

SPATIAL DISTRIBUTION

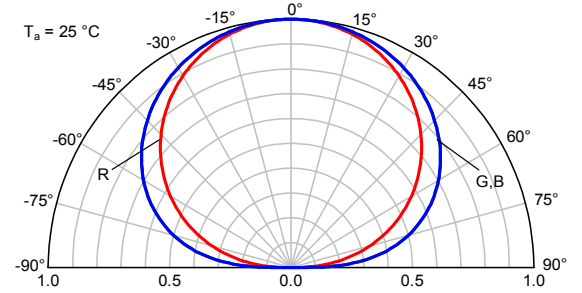

GREEN

Forward Current vs. Forward Voltage

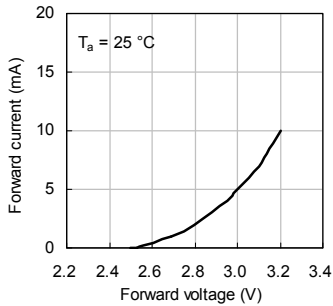

Luminous Intensity vs. Forward Current

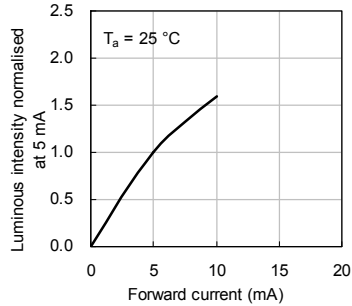

Forward Current Derating Curve

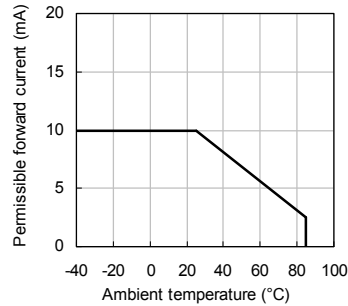

Luminous Intensity vs. Ambient Temperature

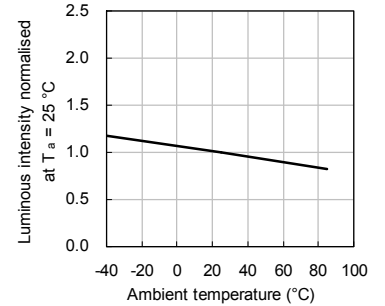

BLUE

Forward Current vs. Forward Voltage

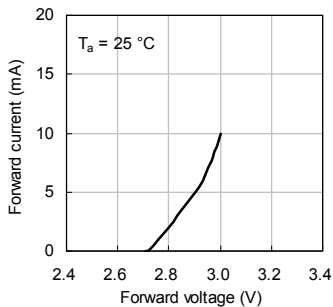

Luminous Intensity vs. Forward Current

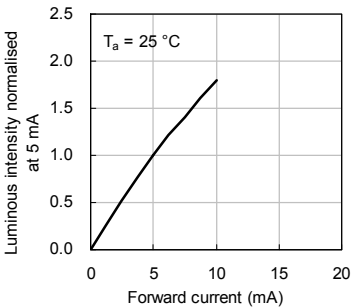

Forward Current Derating Curve

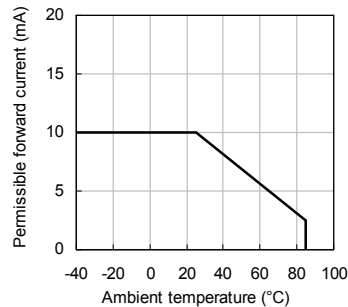

Luminous Intensity vs. Ambient Temperature

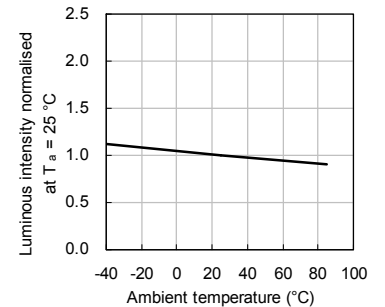

HYPER RED

Forward Current vs. Forward Voltage

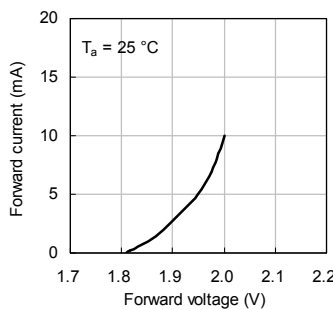

Luminous Intensity vs. Forward Current

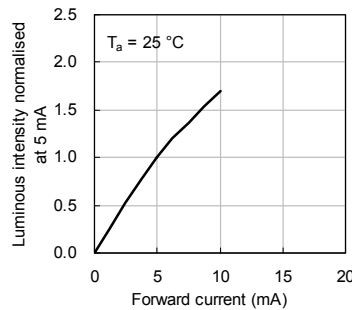

Forward Current Derating Curve

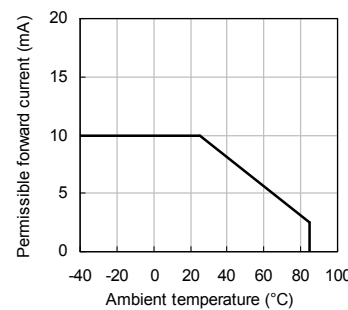

Luminous Intensity vs. Ambient Temperature

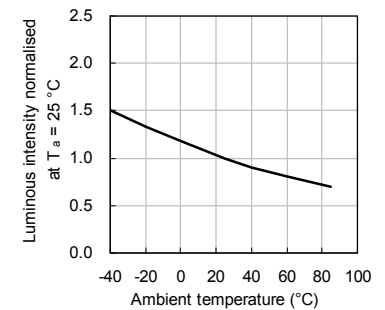

TECHNICAL DATA

REFLOW SOLDERING PROFILE for LEAD-FREE SMD PROCESS

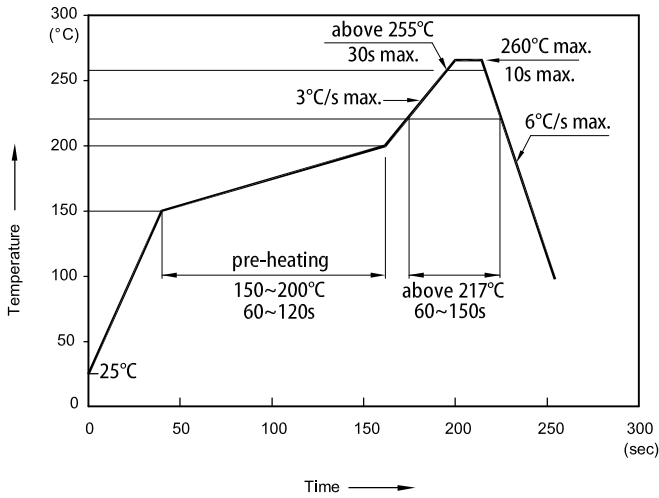

- Notes:
1. Don't cause stress to the LEDs while it is exposed to high temperature.
 2. The maximum number of reflow soldering passes is 2 times.
 3. Reflow soldering is recommended. Other soldering methods are not recommended as they might cause damage to the product.

TAPE SPECIFICATIONS (units : mm)

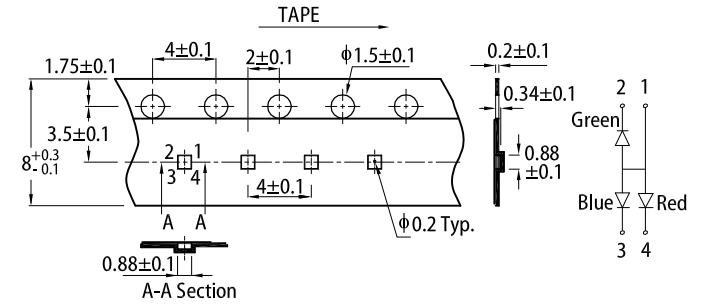

REEL DIMENSION (units : mm)

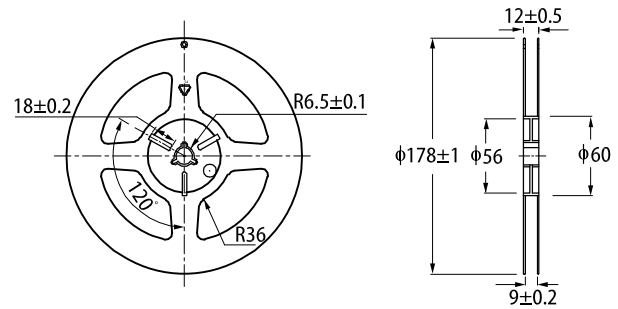

PACKING & LABEL SPECIFICATIONS

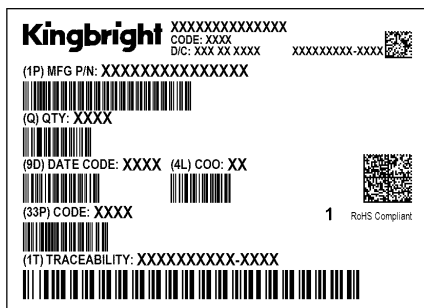
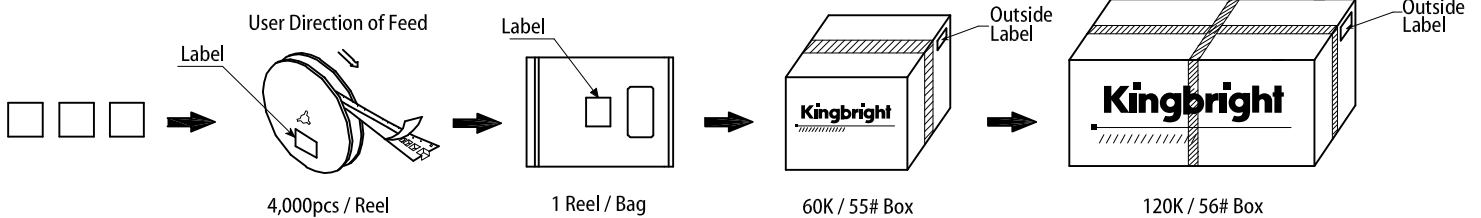

PRECAUTIONARY NOTES

1. The information included in this document reflects representative usage scenarios and is intended for technical reference only.
2. The part number, type, and specifications mentioned in this document are subject to future change and improvement without notice. Before production usage customer should refer to the latest datasheet for the updated specifications.
3. When using the products referenced in this document, please make sure the product is being operated within the environmental and electrical limits specified in the datasheet. If customer usage exceeds the specified limits, Kingbright will not be responsible for any subsequent issues.
4. The information in this document applies to typical usage in consumer electronics applications. If customer's application has special reliability requirements or have life-threatening liabilities, such as automotive or medical usage, please consult with Kingbright representative for further assistance.
5. The contents and information of this document may not be reproduced or re-transmitted without permission by Kingbright.
6. All design applications should refer to Kingbright application notes available at <http://www.KingbrightUSA.com/ApplicationNotes>

X-ON Electronics

Largest Supplier of Electrical and Electronic Components

Click to view similar products for [Standard LEDs - SMD category](#):

Click to view products by [Kingbright manufacturer](#):

Other Similar products are found below :

[LTST-C190KYKT](#) [LTST-C19GD2WT](#) [LTST-N683GBEW](#) [LTW-170ZDC](#) [LTW-M140SZS40](#) [598-8110-100F](#) [598-8170-100F](#) [598-8610-202F](#) [67-22VRVGC/TR8](#) [AAAF5060QBFSEEZGS](#) [HLMA-QG00-S0021](#) [HLMP-6305-L0011](#) [ALMD-LB36-SV002](#) [APT1608QGW](#) [15-21UYC/S530-A3/TR8](#) [EAST2012YA0](#) [EASV1803BA0](#) [LG M67K-H1J2-24-0-2-R18-Z](#) [LS A676-P2S1-1](#) [SML310BATT86](#) [SML-LX0606SISUGC/A](#) [SML-LXL1307SRC-TR](#) [SML-LXR851SIUPGUBC](#) [LT1ED53A](#) [FAT801-S](#) [AM27ZGC03](#) [APB3025SGNC](#) [APFA3010SURKCGKQBDC](#) [APHK1608VGCA](#) [APT2012QGW](#) [LTST-C250KGKT](#) [LTW-010DCG](#) [LTW-020ZDCG](#) [LTW-21TS5](#) [LTW-220DS5](#) [LY L29K-H1J2-26](#) [UYGT801-S](#) [42-21UYC/S530-A3/TR8](#) [LO T67F-V1AB-24-1](#) [YGFR411-H](#) [598-8330-117F](#) [SML-LX0402IC-TR](#) [CMDA20AYAA7D1S](#) [CMDA16AYDR7A1X](#) [598-8040-100F](#) [598-8070-100F](#) [598-8140-100F](#) [598-8610-200F](#) [EAST2012GA0](#) [EAPL3527GA5](#)