

### PRELIMINARY SPEC



**ATTENTION**  
OBSERVE PRECAUTIONS  
FOR HANDLING  
ELECTROSTATIC  
DISCHARGE  
SENSITIVE  
DEVICES

Part Number: APHFT1612PBASURKVGAC

Blue  
Hyper Red  
Green

### Features

- 1.6x1.26mm SMT LED, 0.52mm THICKNESS.
- LOW POWER CONSUMPTION.
- IDEAL FOR BACKLIGHT AND INDICATOR.
- VARIOUS COLORS AND LENS TYPES AVAILABLE.
- PACKAGE : 2000PCS / REEL.
- MOISTURE SENSITIVITY LEVEL : LEVEL 3.
- RoHS COMPLIANT.

### Description

The Blue source color devices are made with InGaN on SiC Light Emitting Diode.

The Hyper Red source color devices are made with DH InGaAlP on GaAs substrate Light Emitting Diode.

The Green source color devices are made with InGaN on G-SiC Light Emitting Diode.

Static electricity and surge damage the LEDs.

It is recommended to use a wrist band or anti-electrostatic glove when handling the LEDs.

All devices, equipment and machinery must be electrically grounded.

### Package Dimensions

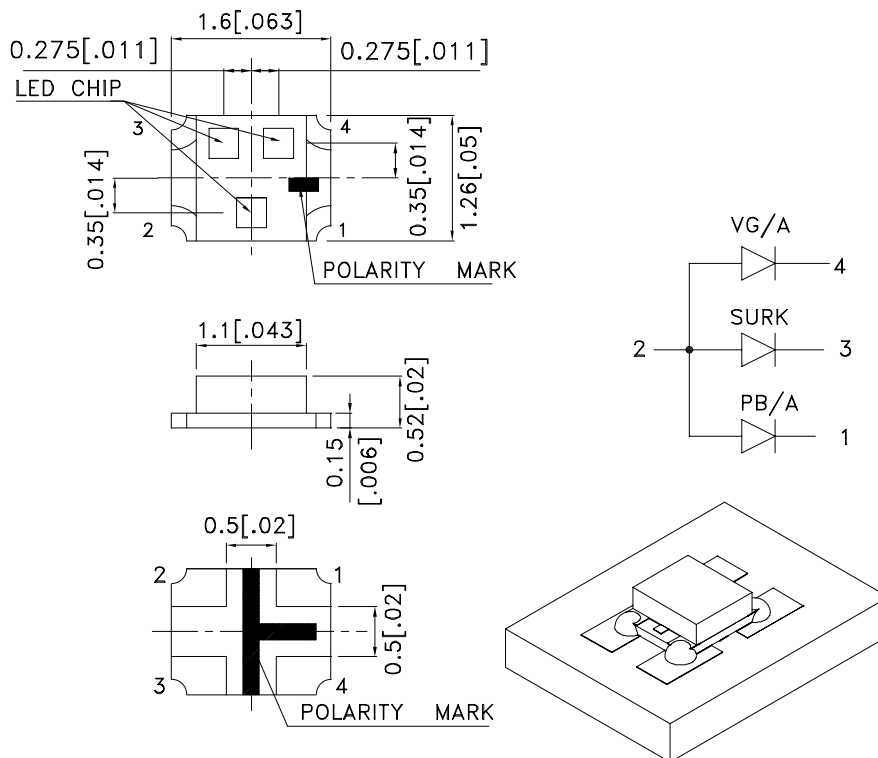

#### Notes:

1. All dimensions are in millimeters (inches).
2. Tolerance is  $\pm 0.2$  (0.008") unless otherwise noted.
3. Specifications are subject to change without notice.
4. The device has a single mounting surface. The device must be mounted according to the specifications.



## Selection Guide

Part No.	Dice	Lens Type	Iv (mcd) [2] @ 20mA		Viewing Angle [1]
			Min.	Typ.	2θ1/2
APHFT1612PBASURKVGAC	Blue (InGaN)	WATER CLEAR	18	60	120°
	Hyper Red (InGaAlP)		70	150	
	Green (InGaN)		70	180	

Notes:

1. θ1/2 is the angle from optical centerline where the luminous intensity is 1/2 the optical centerline value.
2. Luminous intensity/ luminous Flux: +/-15%.

## Electrical / Optical Characteristics at TA=25°C

Symbol	Parameter	Device	Typ.	Max.	Units	Test Conditions
λpeak	Peak Wavelength	Blue Hyper Red Green	468 650 520		nm	I <sub>F</sub> =20mA
λD [1]	Dominant Wavelength	Blue Hyper Red Green	470 635 525		nm	I <sub>F</sub> =20mA
Δλ1/2	Spectral Line Half-width	Blue Hyper Red Green	21 28 35		nm	I <sub>F</sub> =20mA
C	Capacitance	Blue Hyper Red Green	100 35 100		pF	V <sub>F</sub> =0V;f=1MHz
V <sub>F</sub> [2]	Forward Voltage	Blue Hyper Red Green	3.2 1.95 3.2	4 2.5 4	V	I <sub>F</sub> =20mA
I <sub>R</sub>	Reverse Current	Blue Hyper Red Green		10 10 10	μA	V <sub>R</sub> =5V

Notes:

1. Wavelength: +/-1nm.
2. Forward Voltage: +/-0.1V.

## Absolute Maximum Ratings at TA=25°C

Parameter	Blue	Hyper Red	Green	Units
Power dissipation	120	75	120	mW
DC Forward Current	30	30	30	mA
Peak Forward Current [1]	100	185	100	mA
Reverse Voltage	5			V
Operating Temperature	-40°C To +85°C			
Storage Temperature	-40°C To +85°C			

Notes:

1. 1/10 Duty Cycle, 0.1ms Pulse Width.

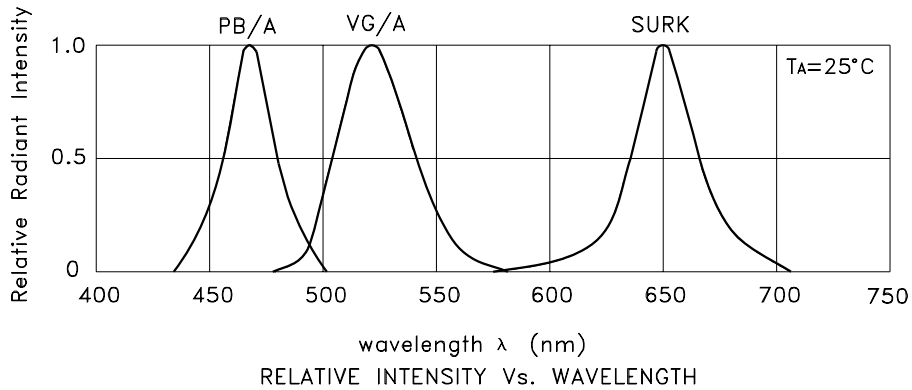

## APHFT1612PBASURKVGAC Blue

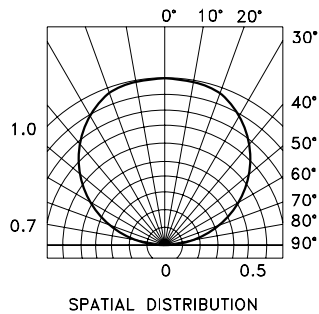
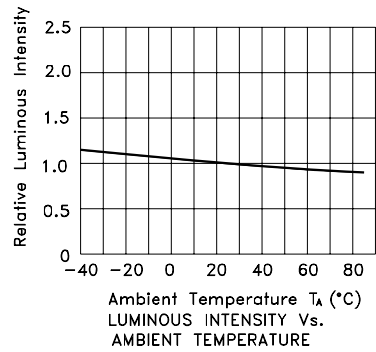
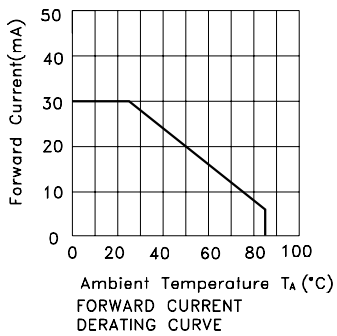
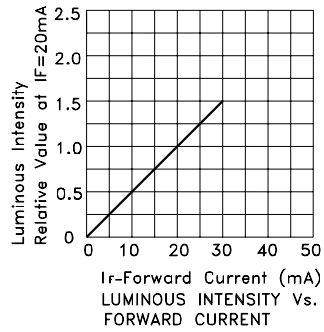
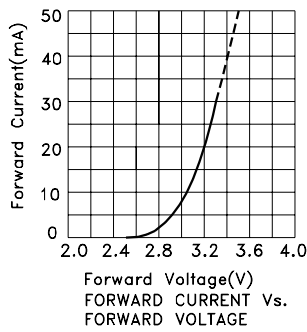

# Kingbright

## Hyper Red

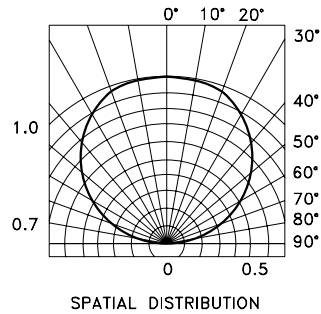
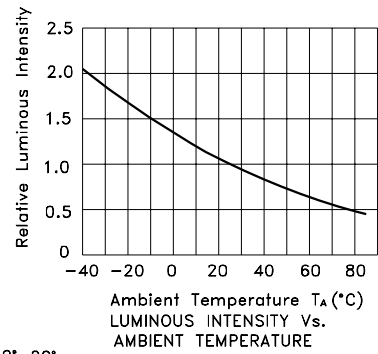
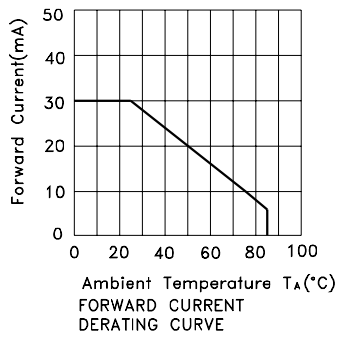
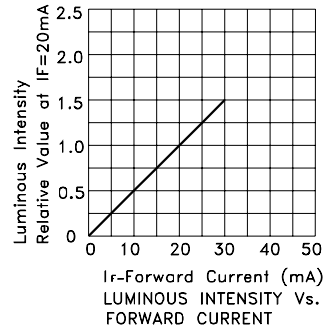
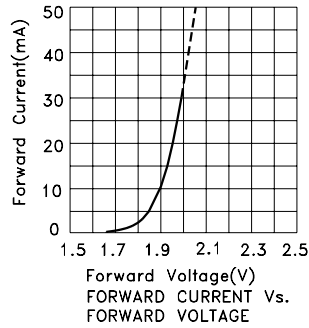

## Green

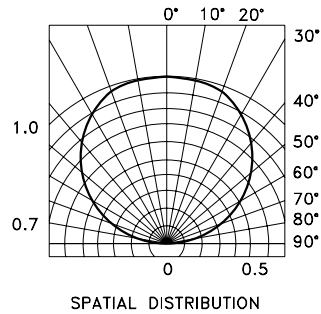
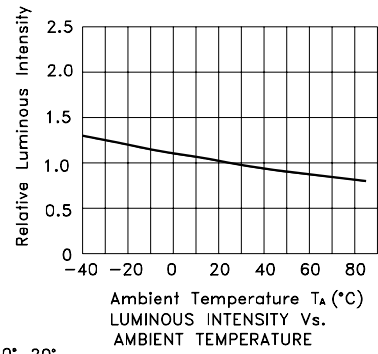
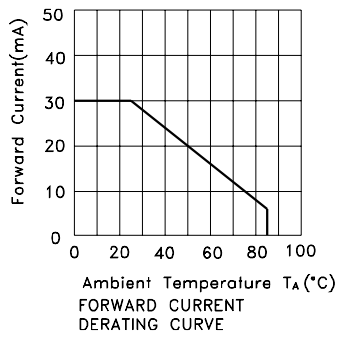
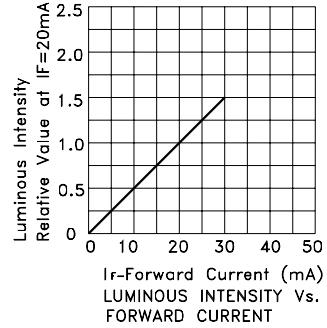
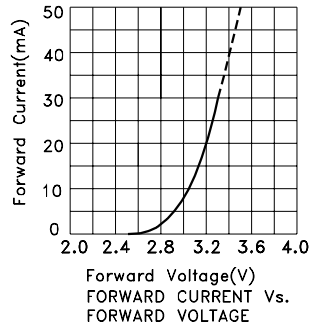

## APHFT1612PBASURKVGAC

Reflow Soldering Profile For Lead-free SMT Process.

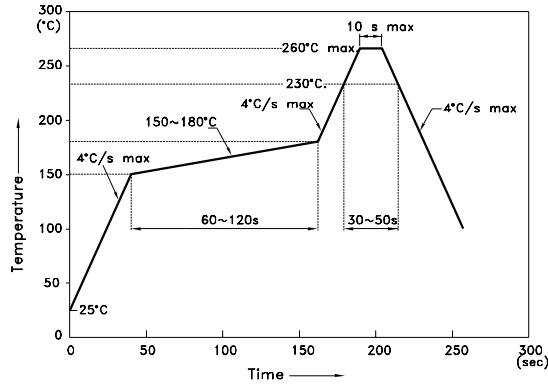

**NOTES:**

1. We recommend the reflow temperature 245°C(+/-5°C). The maximum soldering temperature should be limited to 260°C.
2. Don't cause stress to the epoxy resin while it is exposed to high temperature.
3. Number of reflow process shall be 2 times or less.

### Recommended Soldering Pattern (Units : mm; Tolerance: ± 0.1)

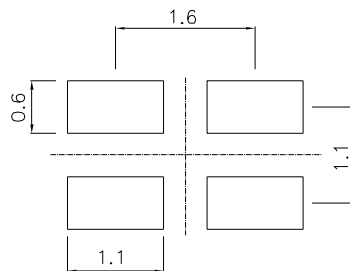

### Tape Specifications (Units : mm)

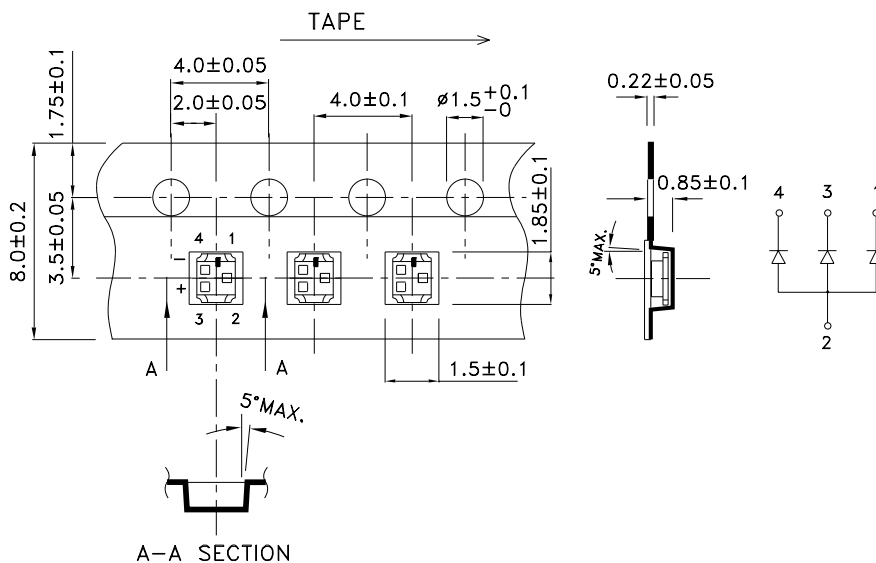

**PACKING & LABEL SPECIFICATIONS**

**APHFT1612PBASURKVGAC**

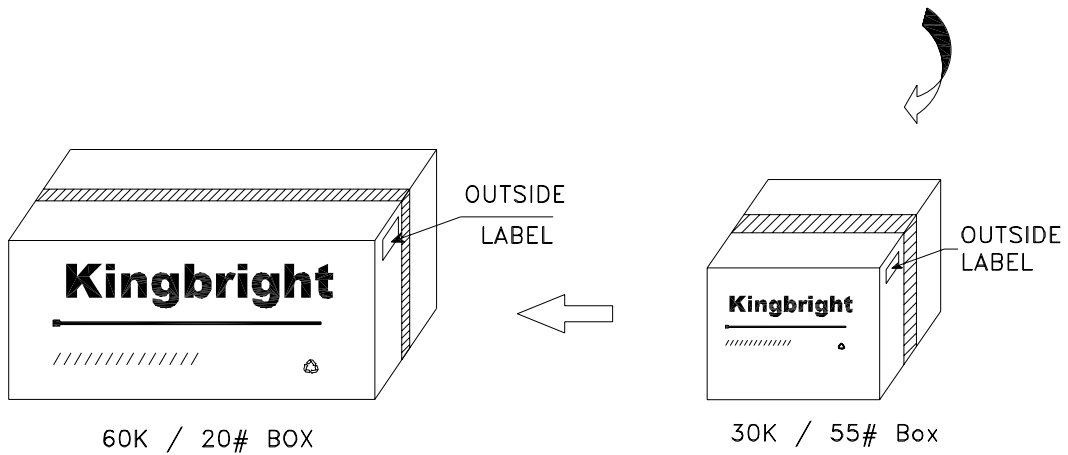
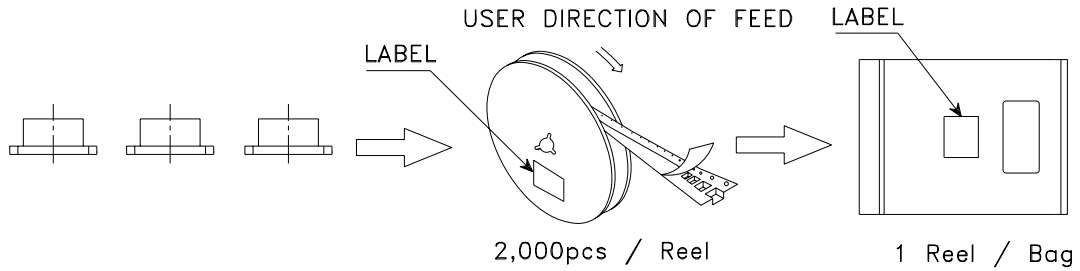

<h2 style="margin: 0;">Kingbright</h2>	
P/NO: APHFT1612xxx	
QTY: 2,000 pcs	Q.C. <span style="border: 1px solid black; border-radius: 50%; padding: 2px; display: inline-block;">Q C xx xx xxxx PASSED</span>
S/N: XXXX	
CODE: XXX	
LOT NO:	
 <small>XXXXXXXXXXXXXXXXXXXXXXXXXXXX</small>	
RoHS Compliant	

## X-ON Electronics

Largest Supplier of Electrical and Electronic Components

*Click to view similar products for [Standard LEDs - SMD category](#):*

*Click to view products by [Kingbright manufacturer](#):*

Other Similar products are found below :

[LTST-C190KYKT](#) [LTST-C19GD2WT](#) [LTST-N683GBEW](#) [LTW-170ZDC](#) [LTW-M140SZS40](#) [598-8110-100F](#) [598-8170-100F](#) [598-8610-202F](#) [67-22VRVGC/TR8](#) [AAAF5060QBFSEEZGS](#) [HLMA-QG00-S0021](#) [HLMP-6305-L0011](#) [ALMD-LB36-SV002](#) [APT1608QGW](#) [15-21UYC/S530-A3/TR8](#) [EAST2012YA0](#) [EASV1803BA0](#) [LG M67K-H1J2-24-0-2-R18-Z](#) [LS A676-P2S1-1](#) [SML310BATT86](#) [SML-LX0606SISUGC/A](#) [SML-LXL1307SRC-TR](#) [SML-LXR851SIUPGUBC](#) [LT1ED53A](#) [FAT801-S](#) [AM27ZGC03](#) [APB3025SGNC](#) [APFA3010SURKCGKQBDC](#) [APHK1608VGCA](#) [APT2012QGW](#) [LTST-C250KGKT](#) [LTW-010DCG](#) [LTW-020ZDCG](#) [LTW-21TS5](#) [LTW-220DS5](#) [LY L29K-H1J2-26](#) [UYGT801-S](#) [42-21UYC/S530-A3/TR8](#) [LO T67F-V1AB-24-1](#) [YGFR411-H](#) [598-8330-117F](#) [SML-LX0402IC-TR](#) [CMDA20AYAA7D1S](#) [CMDA16AYDR7A1X](#) [598-8040-100F](#) [598-8070-100F](#) [598-8140-100F](#) [598-8610-200F](#) [EAST2012GA0](#) [EAPL3527GA5](#)