

APT1608F3C

1.6 x 0.8 mm Infrared Emitting Diode

DESCRIPTION

- F3 Made with Gallium Arsenide Infrared Emitting diodes

FEATURES

- 1.6 mm x 0.8 mm SMD LED, 0.75 mm thickness
- Mechanically and spectrally matched to phototransistor
- Package: 2000 pcs / reel
- Moisture sensitivity level: 3
- Halogen-free
- RoHS compliant

APPLICATIONS

- Infrared Illumination for cameras
- Machine vision systems
- Surveillance systems
- Industrial electronics
- IR data transmission
- Remote control

PACKAGE DIMENSIONS

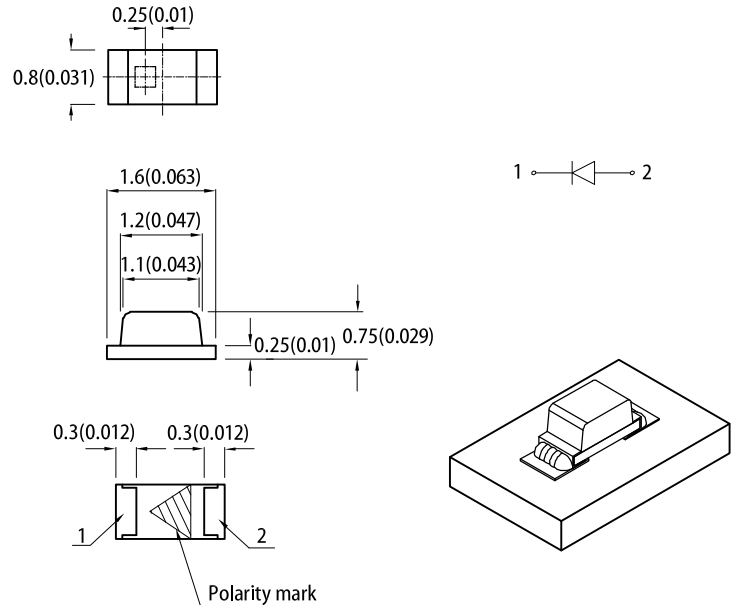

RECOMMENDED SOLDERING PATTERN

(units : mm; tolerance : ± 0.1)

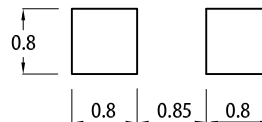

Notes:

- All dimensions are in millimeters (inches).
- Tolerance is $\pm 0.1(0.004)$ unless otherwise noted.
- The specifications, characteristics and technical data described in the datasheet are subject to change without prior notice.
- The device has a single mounting surface. The device must be mounted according to the specifications.

SELECTION GUIDE

| Part Number | Emitting Color (Material) | Lens Type | Po (mW/sr) @ 20mA ^[2] | | Viewing Angle ^[1] |
|-------------|---------------------------|-------------|----------------------------------|------|------------------------------|
| | | | Min. | Typ. | 2θ1/2 |
| APT1608F3C | Infrared (GaAs) | Water Clear | 1.2 | 3 | 150° |
| | | | *0.8 | *2 | |

Notes:
 1. $\theta_{1/2}$ is the angle from optical centerline where the luminous intensity is 1/2 of the optical peak value.
 2. Radiant Intensity / luminous flux: +/-15%.
 * Radiant intensity value is traceable to CIE127-2007 standards.

ELECTRICAL / OPTICAL CHARACTERISTICS at T_A=25°C

| Parameter | Symbol | Emitting Color | Value | | Unit |
|--------------------------------------------------------------------------------------|-------------------------------|----------------|-------|------|-------|
| | | | Typ. | Max. | |
| Wavelength at Peak Emission I _F = 20mA | λ _{peak} | Infrared | 940 | - | nm |
| Spectral Bandwidth at 50% Φ REL MAX I _F = 20mA | Δλ | Infrared | 50 | - | nm |
| Capacitance | C | Infrared | 90 | - | pF |
| Forward Voltage I _F = 20mA | V _F ^[1] | Infrared | 1.2 | 1.6 | V |
| Reverse Current (V _R = 5V) | I _R | Infrared | - | 10 | μA |
| Temperature Coefficient of Wavelength I _F = 20mA, -10°C ≤ T ≤ 85°C | TC _λ | Infrared | 0.3 | - | nm/°C |
| Temperature Coefficient of V _F I _F = 20mA, -10°C ≤ T ≤ 85°C | TC _V | Infrared | -1.2 | - | mV/°C |

Notes:

1. Forward voltage: ±0.1V.
2. Wavelength value is traceable to CIE127-2007 standards.
3. Excess driving current and / or operating temperature higher than recommended conditions may result in severe light degradation or premature failure.

ABSOLUTE MAXIMUM RATINGS at T_A=25°C

| Parameter | Symbol | Value | Unit |
|----------------------------------------------|-----------------------------------|------------|------|
| Power Dissipation | P _D | 90 | mW |
| Reverse Voltage | V _R | 5 | V |
| Junction Temperature | T _j | 115 | °C |
| Operating Temperature | T _{op} | -40 to +85 | °C |
| Storage Temperature | T _{stg} | -40 to +85 | °C |
| DC Forward Current | I _F | 50 | mA |
| Peak Forward Current | I _{FM} ^[1] | 1200 | mA |
| Electrostatic Discharge Threshold (HBM) | - | 8000 | V |
| Thermal Resistance (Junction / Ambient) | R _{th JA} ^[2] | 440 | °C/W |
| Thermal Resistance (Junction / Solder point) | R _{th JS} ^[2] | 290 | °C/W |

Notes:

1. 1/100 Duty Cycle, 10μs Pulse Width.
2. R_{th JA}, R_{th JS} Results from mounting on PC board FR4 (pad size ≥ 16 mm² per pad).
3. Relative humidity levels maintained between 40% and 60% in production area are recommended to avoid the build-up of static electricity – Ref JEDEC/JESD625-A and JEDEC/J-STD-033.

TECHNICAL DATA

RELATIVE INTENSITY vs. WAVELENGTH

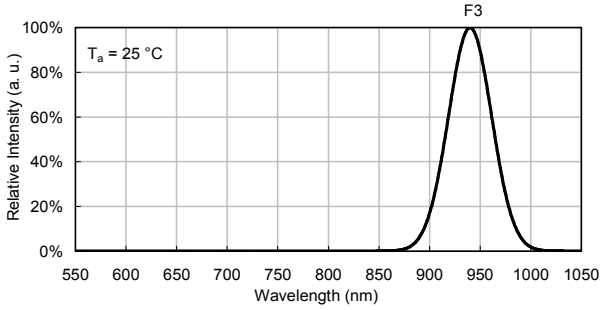

SPATIAL DISTRIBUTION

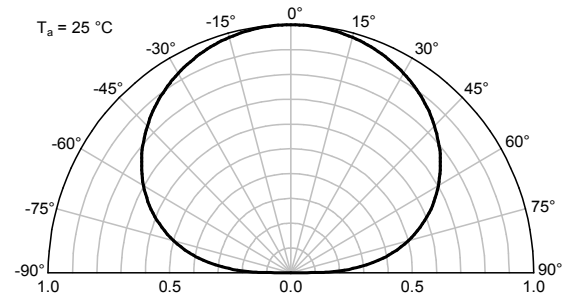

INFRARED

Forward Current vs. Forward Voltage

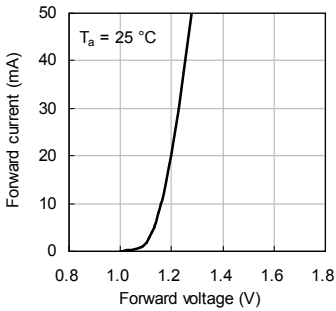

Radiant Intensity vs. Forward Current

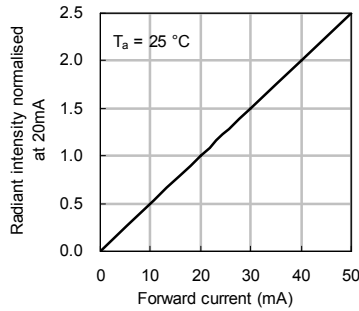

Forward Current Derating Curve

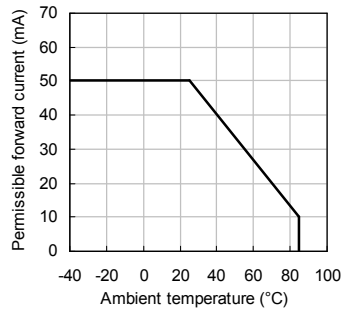

Radiant Intensity vs. Ambient Temperature

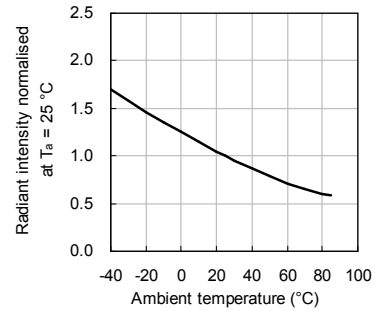

REFLOW SOLDERING PROFILE for LEAD-FREE SMD PROCESS

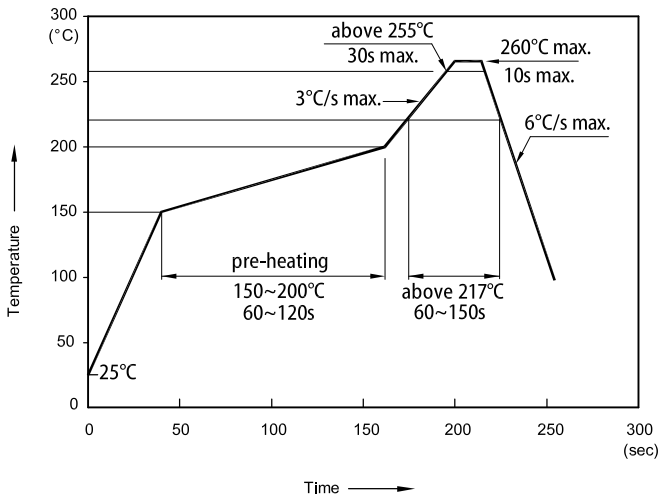

TAPE SPECIFICATIONS (units : mm)

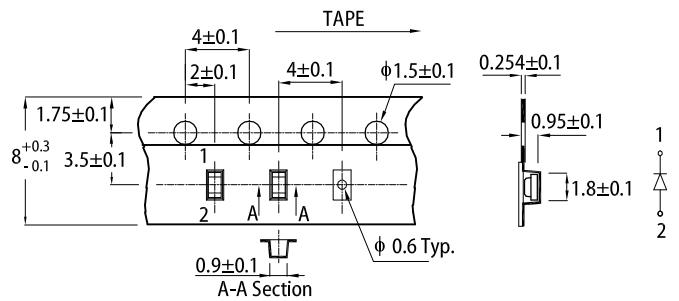

REEL DIMENSION (units : mm)

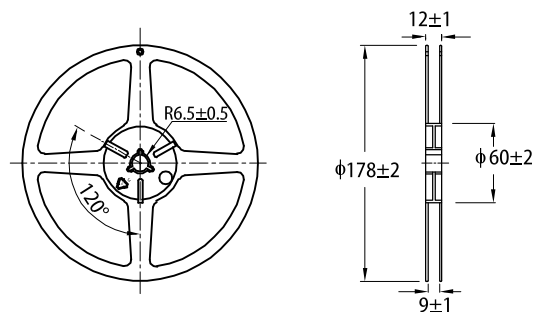

- Notes:
1. Don't cause stress to the LEDs while it is exposed to high temperature.
 2. The maximum number of reflow soldering passes is 2 times.
 3. Reflow soldering is recommended. Other soldering methods are not recommended as they might cause damage to the product.

PACKING & LABEL SPECIFICATIONS

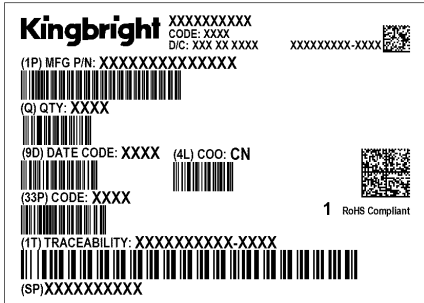
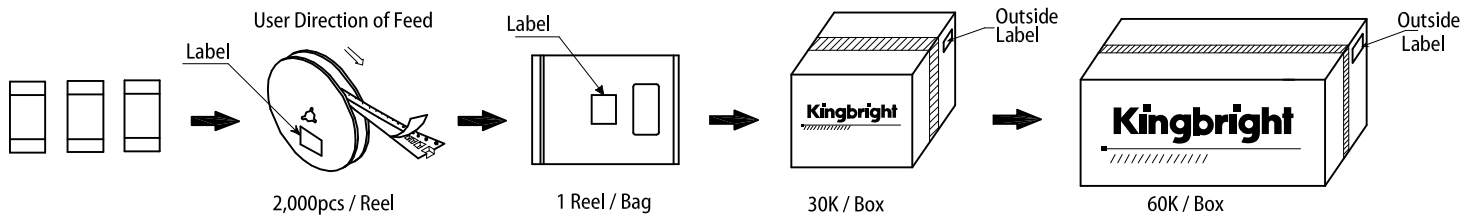

PRECAUTIONARY NOTES

1. The information included in this document reflects representative usage scenarios and is intended for technical reference only.
2. The part number, type, and specifications mentioned in this document are subject to future change and improvement without notice. Before production usage customer should refer to the latest datasheet for the updated specifications.
3. When using the products referenced in this document, please make sure the product is being operated within the environmental and electrical limits specified in the datasheet. If customer usage exceeds the specified limits, Kingbright will not be responsible for any subsequent issues.
4. The information in this document applies to typical usage in consumer electronics applications. If customer's application has special reliability requirements or have life-threatening liabilities, such as automotive or medical usage, please consult with Kingbright representative for further assistance.
5. The contents and information of this document may not be reproduced or re-transmitted without permission by Kingbright.
6. All design applications should refer to Kingbright application notes available at <https://www.KingbrightUSA.com/ApplicationNotes>

X-ON Electronics

Largest Supplier of Electrical and Electronic Components

Click to view similar products for [Infrared Emitters](#) category:

Click to view products by [Kingbright](#) manufacturer:

Other Similar products are found below :

[LTE-309](#) [LTE-3279K](#) [LTE-4206C](#) [LTE-4208C](#) [EAILP03RDAA6](#) [LTE-2871C](#) [LTE-4238](#) [ASDL-4264-C22](#) [OED-EL305F4C50-HT](#) [OP216-004](#) [LTE-3376](#) [EEL109](#) [HL-PST-1608IR1C-L4](#) [SFH 7016](#) [IN-S126DSHIR](#) [IN-S126ETHIR](#) [IN-S42CTQHIR](#) [IN-S63FTHIR](#) [MHT153IRCT](#) [MHS153IRCT](#) [HIR204C/H0](#) [HIR323C](#) [LTE-209](#) [IR12-21C/TR8](#) [IR17-21C/TR8](#) [IR26-21C/L110/TR8](#) [IR91-21C/TR10](#) [KM-4457F3C](#) [L-53F3BT](#) [WP3A10F3C](#) [LTE-4208](#) [IR42-21C/TR8](#) [HSDL-4261](#) [APA3010F3C-GX](#) [SE2460-140](#) [OP266-905](#) [OP280D](#) [LTE-2871](#) [HIR8323/C16](#) [KP-2012SF4C](#) [KPA-3010F3C](#) [L-7113SF6C](#) [HIR19-21C/L11/TR8](#) [IR19-21C/TR8](#) [IR11-21C/TR8](#) [IR204/H60](#) [L-34F3C](#) [L-34SF4C](#) [L-7104F3BT](#) [HIR204C](#)