

PRELIMINARY SPEC

Part Number: APT1608VGC/Z-PRV      Green



**ATTENTION**  
OBSERVE PRECAUTIONS  
FOR HANDLING  
ELECTROSTATIC  
DISCHARGE  
SENSITIVE  
DEVICES

**Features**

- 1.6mmX0.8mm SMT LED, 0.75mm thickness.
- Low power consumption.
- Wide viewing angle.
- Ideal for backlight and indicator.
- Various colors and lens types available.
- Package: 2000pcs / reel .
- Moisture sensitivity level : level 3.
- RoHS compliant.

**Description**

The Green source color devices are made with InGaN Light Emitting Diode.

Static electricity and surge damage the LEDs.

It is recommended to use a wrist band or anti-electrostatic glove when handling the LEDs.

All devices, equipment and machinery must be electrically grounded.

**Package Dimensions**

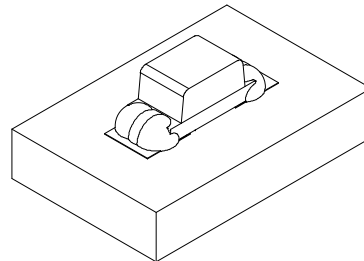
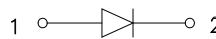
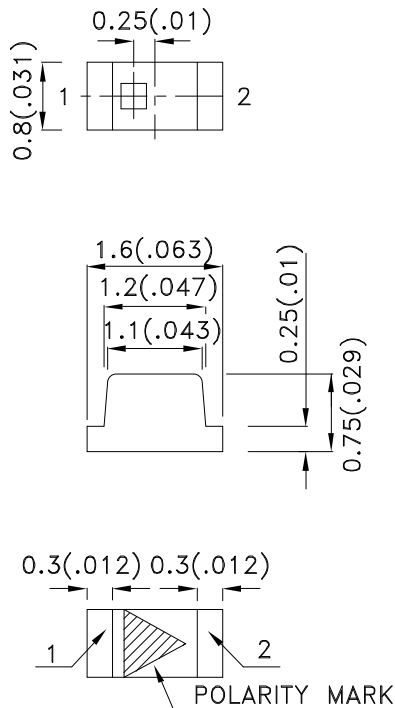

Notes:

1. All dimensions are in millimeters (inches).
2. Tolerance is  $\pm 0.1(0.004)$  unless otherwise noted.
3. Specifications are subject to change without notice.
4. The device has a single mounting surface. The device must be mounted according to the specifications.



## Selection Guide

| Part No.         | Dice          | Lens Type   | Iv (mcd) [2]<br>@ 20mA |      | Viewing<br>Angle [1] |
|------------------|---------------|-------------|------------------------|------|----------------------|
|                  |               |             | Min.                   | Typ. | 2θ1/2                |
| APT1608VGC/Z-PRV | Green (InGaN) | WATER CLEAR | 180                    | 400  | 120°                 |

Notes:

1. θ1/2 is the angle from optical centerline where the luminous intensity is 1/2 the optical centerline value.
2. Luminous intensity/ luminous Flux: +/-15%.

## Electrical / Optical Characteristics at TA=25°C

| Symbol             | Parameter                | Device | Typ. | Max. | Units | Test Conditions           |
|--------------------|--------------------------|--------|------|------|-------|---------------------------|
| λ <sub>peak</sub>  | Peak Wavelength          | Green  | 525  |      | nm    | I <sub>F</sub> =20mA      |
| λ <sub>D</sub> [1] | Dominant Wavelength      | Green  | 535  |      | nm    | I <sub>F</sub> =20mA      |
| Δλ <sub>1/2</sub>  | Spectral Line Half-width | Green  | 39   |      | nm    | I <sub>F</sub> =20mA      |
| C                  | Capacitance              | Green  | 65   |      | pF    | V <sub>F</sub> =0V;f=1MHz |
| V <sub>F</sub> [2] | Forward Voltage          | Green  | 3.2  | 3.7  | V     | I <sub>F</sub> =20mA      |
| I <sub>R</sub>     | Reverse Current          | Green  |      | 10   | uA    | V <sub>R</sub> =5V        |

Notes:

- 1.Wavelength: +/-1nm.
2. Forward Voltage: +/-0.1V.

## Absolute Maximum Ratings at TA=25°C

| Parameter                | Green          | Units |
|--------------------------|----------------|-------|
| Power dissipation        | 111            | mW    |
| DC Forward Current       | 30             | mA    |
| Peak Forward Current [1] | 100            | mA    |
| Reverse Voltage          | 5              | V     |
| Operating Temperature    | -40°C To +85°C |       |
| Storage Temperature      | -40°C To +85°C |       |

Note:

1. 1/10 Duty Cycle, 0.1ms Pulse Width.

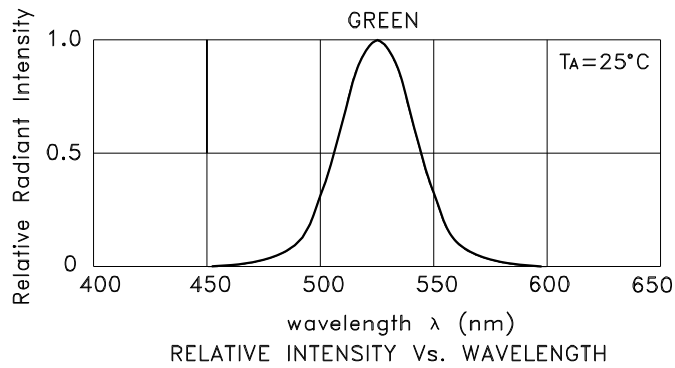

**Green**

**APT1608VGC/Z-PRV**

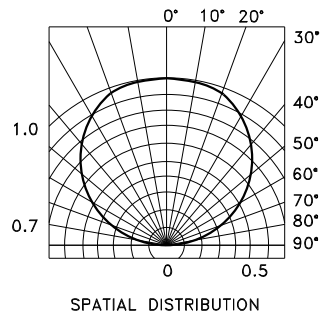
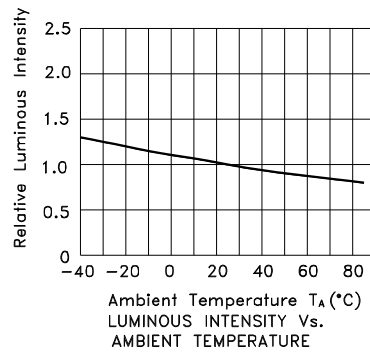
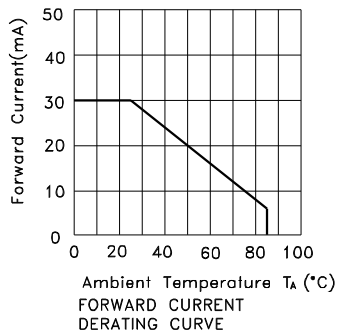
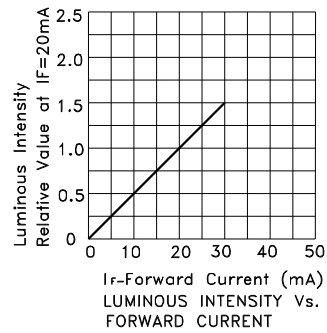
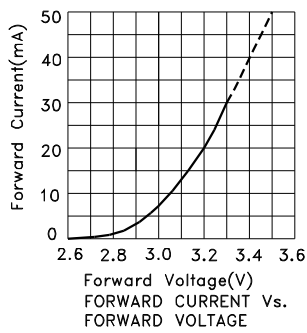

## APT1608VGC/Z-PRV

Reflow soldering is recommended and the soldering profile is shown below.  
Other soldering methods are not recommended as they might cause damage to the product.

Reflow Soldering Profile For Lead-free SMT Process.

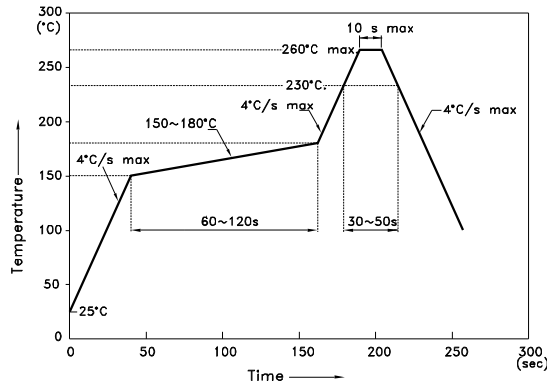

NOTES:

1. We recommend the reflow temperature 245°C(+/-5°C). The maximum soldering temperature should be limited to 260°C.
2. Don't cause stress to the epoxy resin while it is exposed to high temperature.
3. Number of reflow process shall be 2 times or less.

### Recommended Soldering Pattern (Units : mm; Tolerance: ± 0.1)

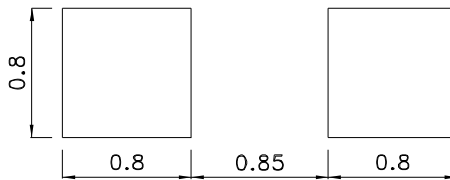

### Tape Dimensions (Units : mm)

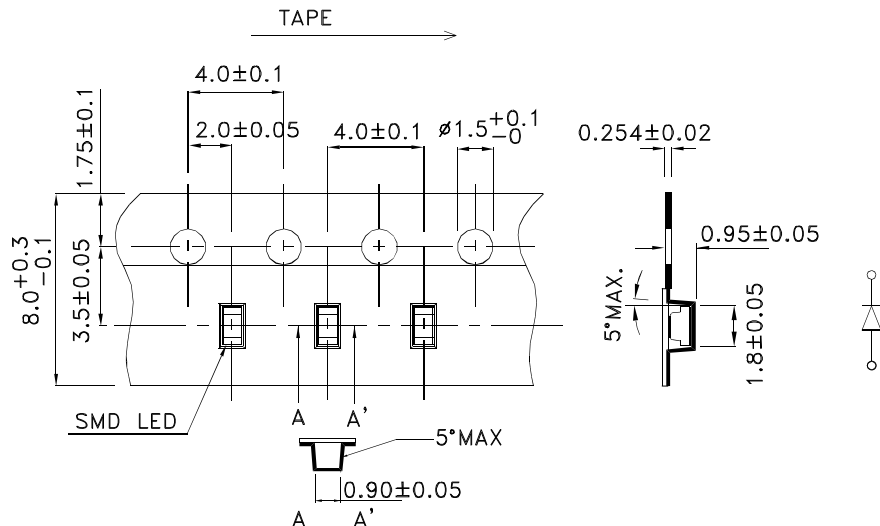

**PACKING & LABEL SPECIFICATIONS**

**APT1608VGC/Z-PRV**

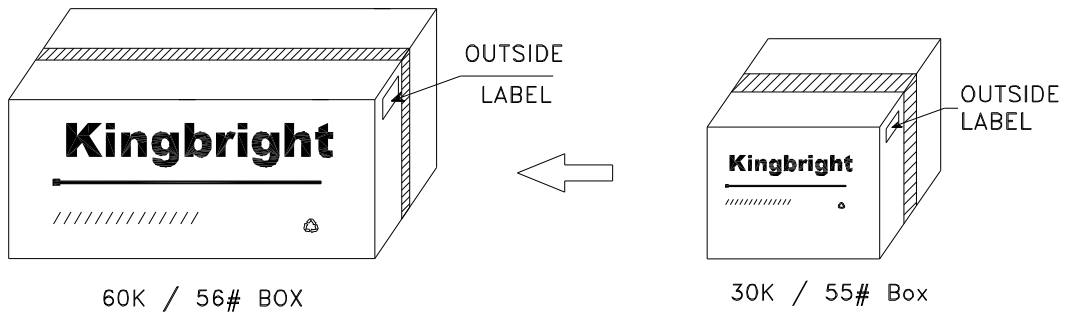
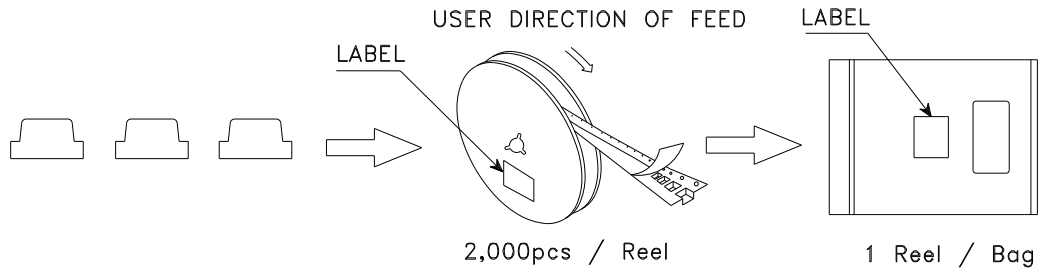

|  |   |
|--|---|
| <h2 style="margin: 0;">Kingbright</h2> |   |
| P/NO: APT1608xxx                       |   |
| QTY: 2,000 pcs                         | Q.C. <span style="border: 1px solid black; border-radius: 50%; padding: 2px; display: inline-block;">Q C<br/>xx xx xxxx<br/>PASSED</span> |
| S/N: XXXX                              |   |
| CODE: XXX                              |   |
| LOT NO:                                |   |
|  |   |
| xxxxxxxxxxxxxxxxxxxxxxxxxxxxxxxx       |   |
| RoHS Compliant                         |   |

## X-ON Electronics

Largest Supplier of Electrical and Electronic Components

*Click to view similar products for [Standard LEDs - SMD category](#):*

*Click to view products by [Kingbright manufacturer](#):*

Other Similar products are found below :

[LTST-C190KYKT](#) [LTST-C19GD2WT](#) [LTST-N683GBEW](#) [LTW-170ZDC](#) [LTW-M140SZS40](#) [598-8110-100F](#) [598-8170-100F](#) [598-8610-202F](#) [67-22VRVGC/TR8](#) [AAAF5060QBFSEEZGS](#) [HLMA-QG00-S0021](#) [HLMP-6305-L0011](#) [ALMD-LB36-SV002](#) [APT1608QGW](#) [15-21UYC/S530-A3/TR8](#) [EAST2012YA0](#) [EASV1803BA0](#) [LG M67K-H1J2-24-0-2-R18-Z](#) [LS A676-P2S1-1](#) [SML310BATT86](#) [SML-LX0606SISUGC/A](#) [SML-LXL1307SRC-TR](#) [SML-LXR851SIUPGUBC](#) [LT1ED53A](#) [FAT801-S](#) [AM27ZGC03](#) [APB3025SGNC](#) [APFA3010SURKCGKQBDC](#) [APHK1608VGCA](#) [APT2012QGW](#) [LTST-C250KGKT](#) [LTW-010DCG](#) [LTW-020ZDCG](#) [LTW-21TS5](#) [LTW-220DS5](#) [LY L29K-H1J2-26](#) [UYGT801-S](#) [42-21UYC/S530-A3/TR8](#) [LO T67F-V1AB-24-1](#) [YGFR411-H](#) [598-8330-117F](#) [SML-LX0402IC-TR](#) [CMDA20AYAA7D1S](#) [CMDA16AYDR7A1X](#) [598-8040-100F](#) [598-8070-100F](#) [598-8140-100F](#) [598-8610-200F](#) [EAST2012GA0](#) [EAPL3527GA5](#)