

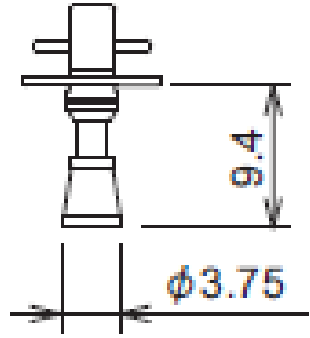

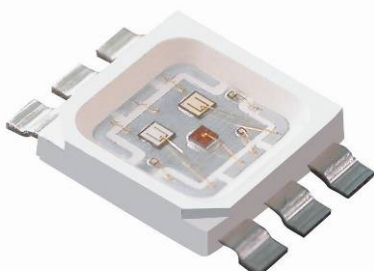

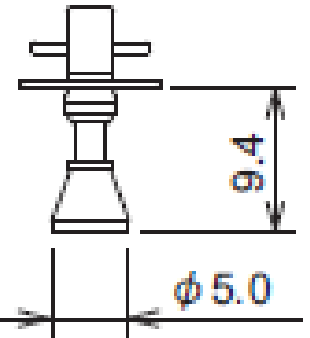





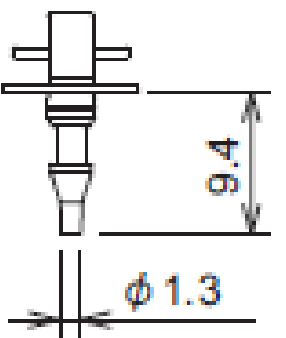

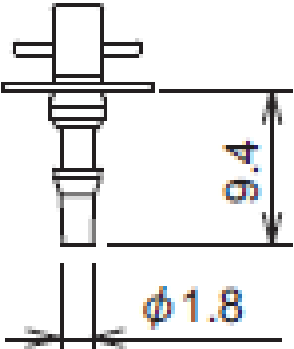

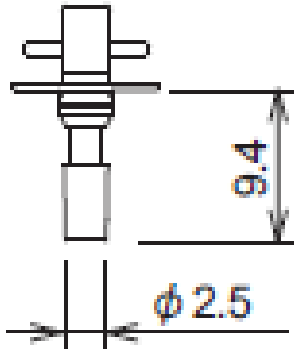
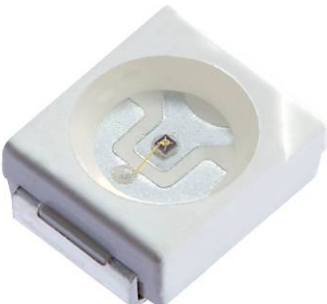
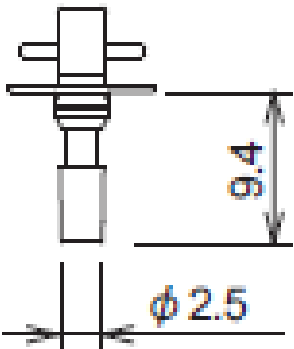

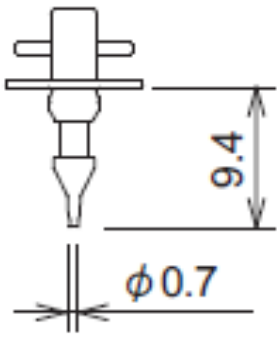
Recommended Pickup Nozzles for Kingbright SMD LED

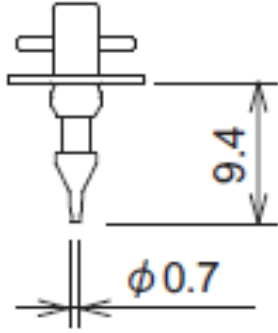

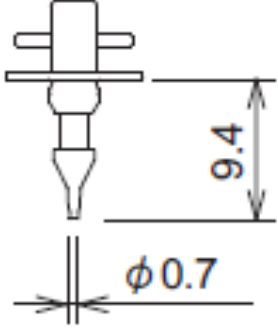

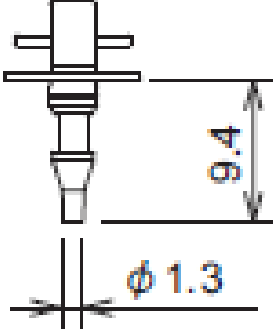
SMD LED Pickup Nozzle Suggestions

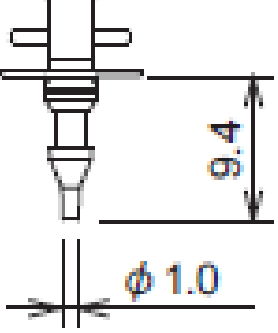

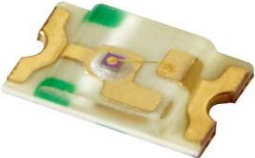
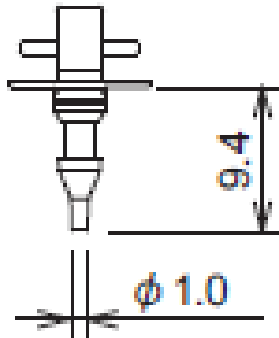
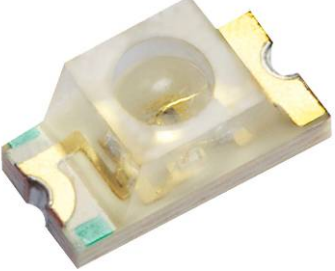
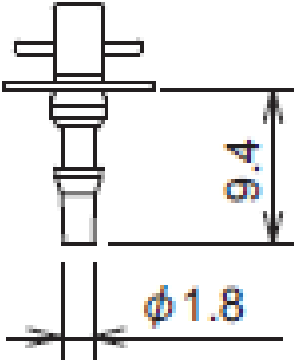
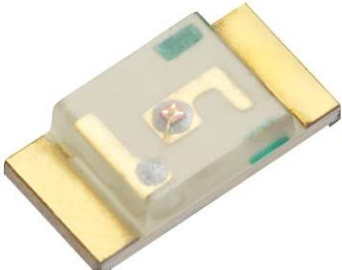
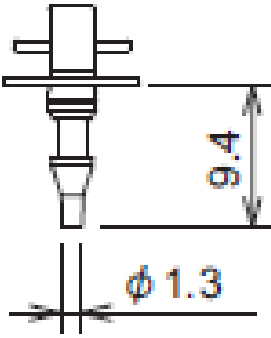
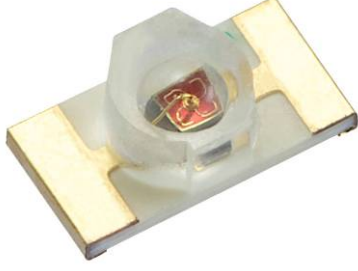
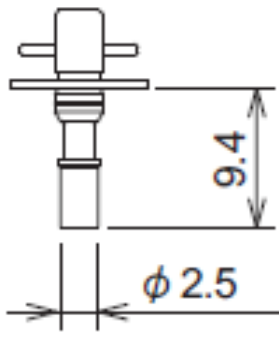

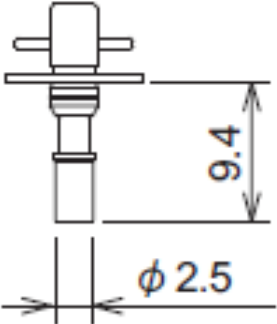

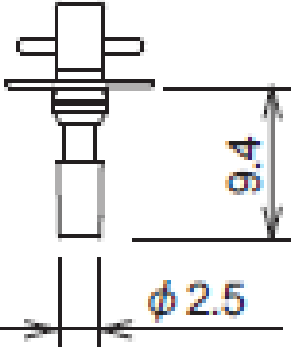
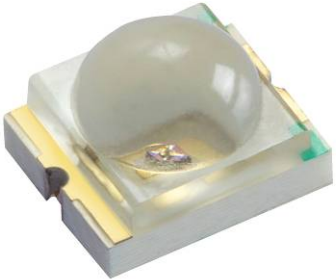
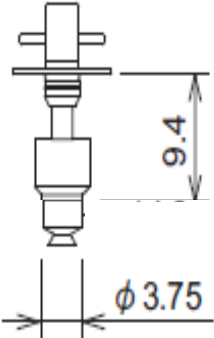
Part No.	FUJI NXT Reference Tool Number	Recommended nozzle for FUJI NXT pick & place machines
<p>0.5W HIGH BRIGHTNESS LED</p>  <p>KA-3535</p>	R07-037-070	
<p>1.5W HIGH BRIGHTNESS LED</p>  <p>KAAF-5051</p>	R07-050-070	
<p>TOP-EMITTING PLCC SMD LED</p>  <p>KA-2214</p>	R07-013-070	

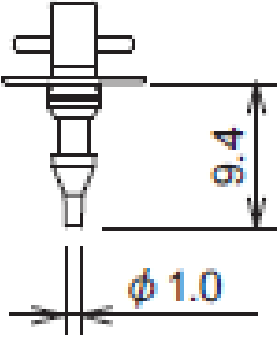

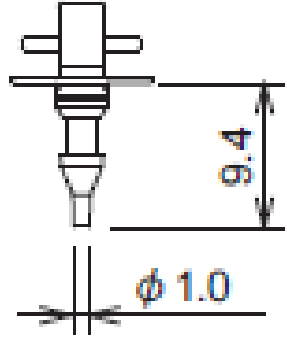

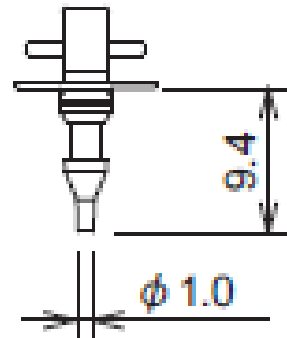
Part No.	FUJI NXT Reference Tool Number	Recommended nozzle for FUJI NXT pick & place machines
<p>TOP-EMITTING PLCC SMD LED</p>  <p>KA-3021</p>	R07-018-070	
<p>TOP-EMITTING PLCC SMD LED</p>  <p>KA-3527A</p>	R07-025-070	
<p>TOP-EMITTING PLCC SMD LED</p>  <p>KA-3528</p>	R07-025-070	
<p>TOP-EMITTING CHIP SMD LED</p>  <p>KPHHS-1005</p>	R07-007-070	

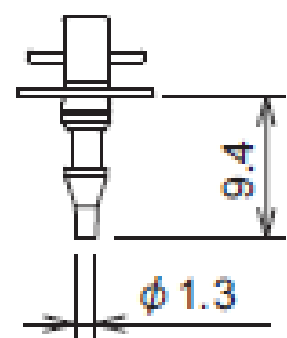

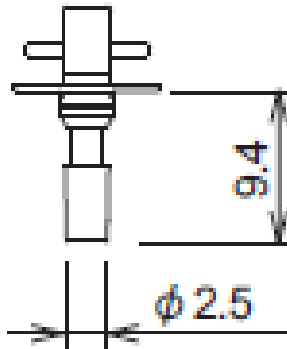

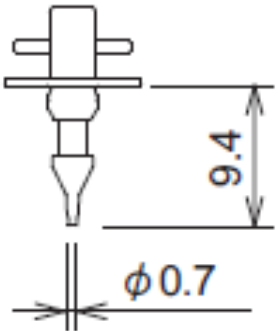
Part No.	FUJI NXT Reference Tool Number	Recommended nozzle for FUJI NXT pick & place machines
<p>TOP-EMITTING CHIP SMD LED</p>  <p>KPG-1608</p>	R07-007-070	
<p>TOP-EMITTING CHIP SMD LED</p>  <p>KPT-1608</p>	R07-007-070	
<p>TOP-EMITTING CHIP SMD LED</p>  <p>KPTD-1608</p>	R07-013G-070 (R07-010F-070)	
<p>TOP-EMITTING CHIP SMD LED</p>  <p>KPT-2012</p>	R07-010-070	

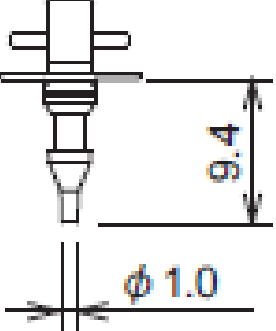
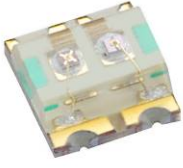
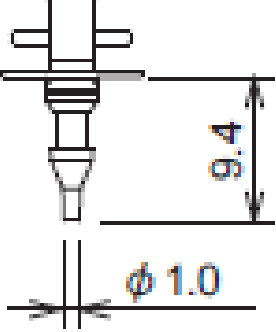

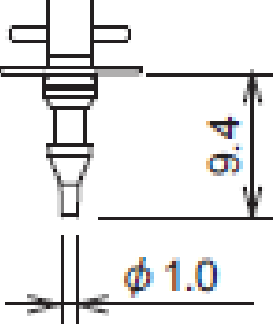

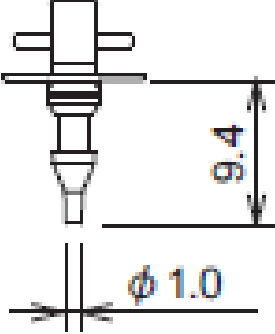
Part No.	FUJI NXT Reference Tool Number	Recommended nozzle for FUJI NXT pick & place machines
<p>TOP-EMITTING CHIP SMD LED</p>  <p>KPHCM-2012</p>	R07-010-070	
<p>TOP-EMITTING CHIP SMD LED</p>  <p>KPL-3015</p>	R07-018-070	
<p>TOP-EMITTING CHIP SMD LED</p>  <p>KPT-3216</p>	R07-013-070	
<p>TOP-EMITTING CHIP SMD LED</p>  <p>KPTL-3216</p>	R07-025G-070	

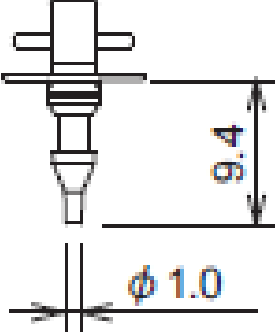
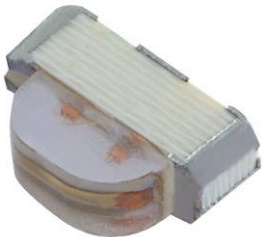
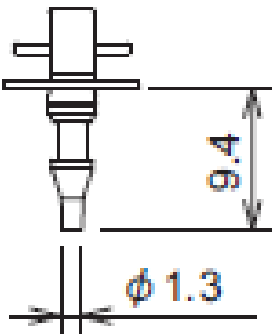

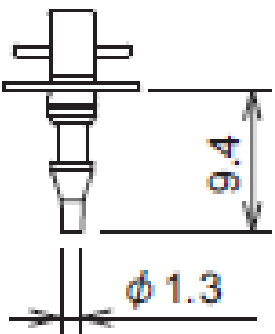

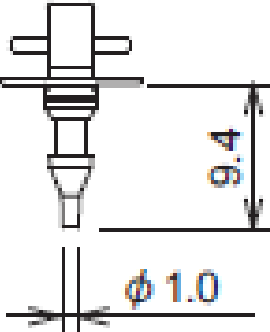
Part No.	FUJI NXT Reference Tool Number	Recommended nozzle for FUJI NXT pick & place machines
<p>TOP-EMITTING CHIP SMD LED</p>  <p>KPTD-3216</p>	R07-025G-070	
<p>TOP-EMITTING CHIP SMD LED</p>  <p>KPD-3223</p>	R07-025-070	
<p>TOP-EMITTING CHIP SMD LED</p>  <p>KPED-3528</p>	R07-037G-070	
<p>RIGHT ANGLE SMD LED</p>  <p>KPA-1606</p>	R07-010-070	

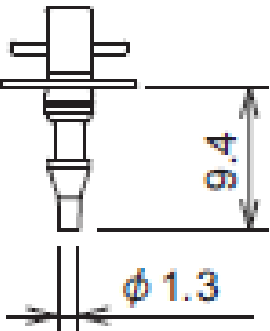

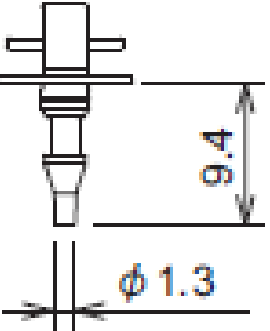
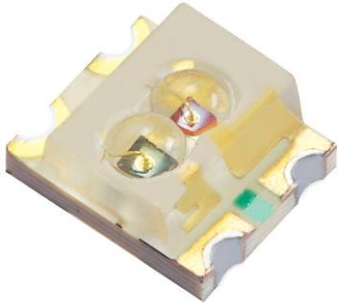
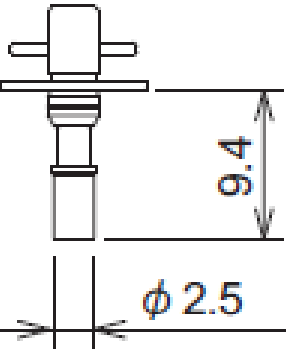

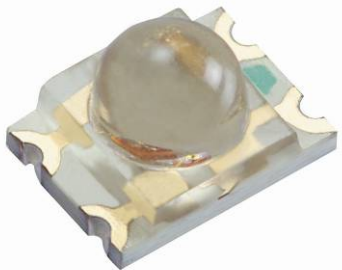
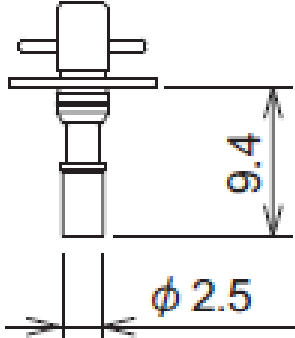
Part No.	FUJI NXT Reference Tool Number	Recommended nozzle for FUJI NXT pick & place machines
<p>RIGHT ANGLE SMD LED</p>  <p>KPA-2106</p>	R07-010-070	
<p>RIGHT ANGLE SMD LED</p>  <p>KA-2810A</p>	R07-010-070	
<p>RIGHT ANGLE SMD LED</p>  <p>KPA-3010</p>	R07-013-070	
<p>RIGHT ANGLE SMD LED</p>  <p>KA-4040</p>	R07-025-070	

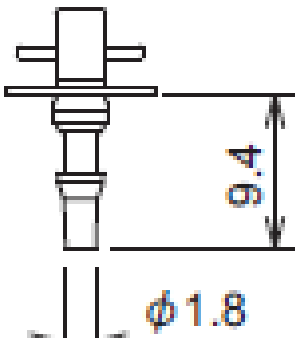
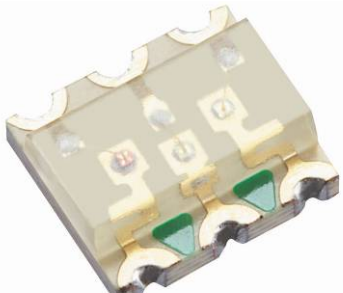
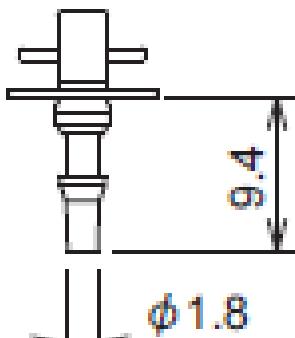
Part No.	FUJI NXT Reference Tool Number	Recommended nozzle for FUJI NXT pick & place machines
<p>MULTI-COLOR SMD LED</p>  <p>KPHB-1608</p>	R07-007-070	
<p>MULTI-COLOR SMD LED</p>  <p>KPTB-1612</p>	R07-010-070	
<p>MULTI-COLOR SMD LED</p>  <p>KPTB-1615</p>	R07-010-070	
<p>MULTI-COLOR SMD LED</p>  <p>KPTF-1616</p>	R07-010-070	

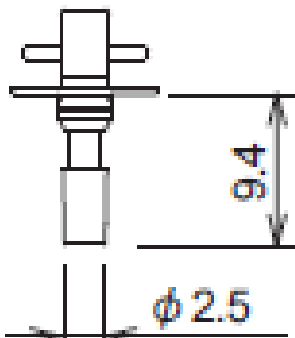
Part No.	FUJI NXT Reference Tool Number	Recommended nozzle for FUJI NXT pick & place machines
<p>MULTI-COLOR SMD LED</p>  <p>KPHBM-2012</p>	R07-010-070	
<p>MULTI-COLOR SMD LED</p>  <p>KPB-2012</p>	R07-010-070	
<p>MULTI-COLOR SMD LED</p>  <p>KPBA-3010</p>	R07-013-070	
<p>MULTI-COLOR SMD LED</p>  <p>KPFA-3010</p>	R07-013-070	

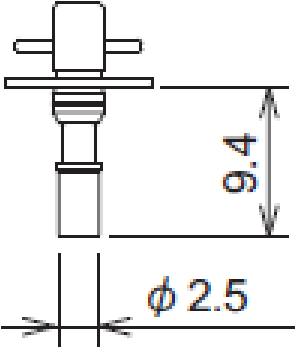
Part No.	FUJI NXT Reference Tool Number	Recommended nozzle for FUJI NXT pick & place machines
<p>MULTI-COLOR SMD LED</p>  <p>KM-23</p>	R07-010-070	
<p>MULTI-COLOR SMD LED</p>  <p>KPBDA-3020</p>	R07-013-070	
<p>MULTI-COLOR SMD LED</p>  <p>KPB-3025</p>	R07-013-070	
<p>MULTI-COLOR SMD LED</p>  <p>KPBL-3025</p>	R07-025G-070	

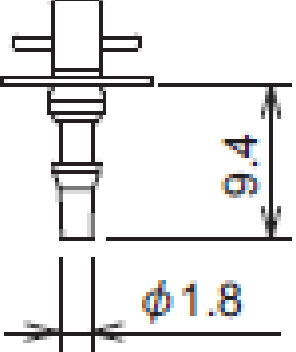
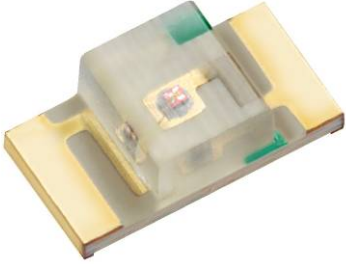
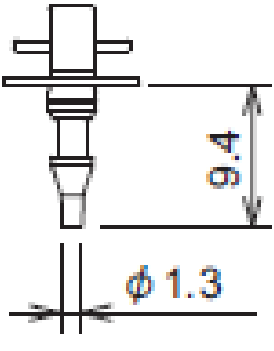
Part No.	FUJI NXT Reference Tool Number	Recommended nozzle for FUJI NXT pick & place machines
<p>MULTI-COLOR SMD LED</p>  <p>KPBD-3224</p>	R07-025G-070	
<p>MULTI-COLOR SMD LED</p>  <p>KPB-3227</p>	R07-018-070	
<p>MULTI-COLOR SMD LED</p>  <p>KPF-3236</p>	R07-018-070	
<p>MULTI-COLOR SMD LED</p>  <p>KAAF-3529</p>	R07-025-070	

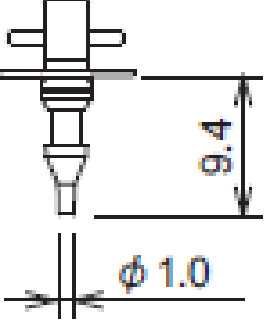
Part No.	FUJI NXT Reference Tool Number	Recommended nozzle for FUJI NXT pick & place machines
<p>SUBMINIATURE SMD LED</p>  <p>KM2520-03</p>	R07-025G-070	
<p>SUBMINIATURE SMD LED</p>  <p>KM2520-09</p>	R07-018-070	
<p>REVERSE MOUNT SMD LED</p>  <p>KPTR-3216</p>	R07-013-070	
<p>SOT-23 SMD LED</p>  <p>KM-23-F</p>	R07-010-070	

Notes:

1. If other types of pick & place machines are used, please use the appropriate tool similar to the suggested dimensions and structures for the production process.
2. For components with unique properties such as dome lenses, silicone lenses, and heavier parts, reduced picking speed may help prevent pickup issues and insure production stability.
3. To insure smooth pickup and prevent fling-out of small components such as 1005 series, please insure nozzle and feeder are well maintained to reduce vibrations and maintain picking accuracy.
4. The distance between the nozzle and the component may be set closer to improve pickup in older SMT machines.
5. For LEDs with silicone encapsulation such as the KA and KT series, the outer diameter of the pick-up nozzle must be longer than that of the LED's light emitting area. i. e. $A > C$, and B shall be shorter than the width of the LED.

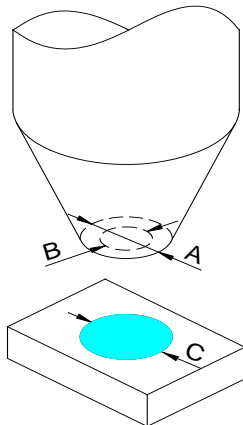

A is the outer diameter pick-up nozzle, B is the inner diameter of pick-up nozzle, and C is the light emitting area of LED

X-ON Electronics

Largest Supplier of Electrical and Electronic Components

Click to view similar products for [Standard LEDs - SMD category](#):

Click to view products by [Kingbright manufacturer](#):

Other Similar products are found below :

[LTST-C19GD2WT](#) [LTST-N683GBEW](#) [597-3006-607F](#) [597-3403-607F](#) [LTW-K140SZR40](#) [LTW-M140ZVS](#) [598-8110-100F](#) [598-8170-100F](#)
[598-8610-202F](#) [7012X7](#) [AAAF5060QBFSEEZGS](#) [12-22SURSYGC/S530-A3/E2/TR8](#) [1383SURT/S530-A3/TR1\(R\)](#) [APT1608QGW](#)
[EASV1803BA0](#) [SML310BATT86](#) [SML-512VWT86A](#) [SML-LX0606SISUGC/A](#) [SML-LXL1307SRC-TR](#) [SML-LXR851SIUPGUBC](#)
[LT1ED53A](#) [17-21/G6C-FM1N2B/3T](#) [FAT801-S](#) [SSL-LXA227IC-TR31A](#) [AM27ZGC03](#) [APB3025SGNC](#) [APHK1608VGCA](#) [APT2012QGW](#)
[CLMVC-FKA-CA1E1L81BB7C3C3](#) [CLYBA-FKA-CFHHL9BBB7A363](#) [CMD11504UR](#) [LTW-020ZDCG](#) [LTW-21TS5](#) [LTW-K140SZR30](#)
[HSMY-C177](#) [UYGT801-S](#) [KVH1C100MF6R](#) [42-21SYGC/S530-E1/TR8](#) [YGFR411-H](#) [597-2311-402F](#) [597-2712-602F](#) [5973212407NF](#)
[597-3302-607F](#) [597-5202-407F](#) [598-8330-117F](#) [SAW8WA2A-L35M40-CA](#) [SML013WBDW1](#) [SML-LX0402IC-TR](#) [CLMVC-FKA-](#)
[CLBDGL7LBB79353](#) [VLMKG3400-GS08](#)