

Part Number: PSA12-11SRWA SUPER BRIGHT RED

Features

- 1.2 INCH CHARACTER HEIGHT .
- LOW CURRENT OPERATION.
- HIGH CONTRAST AND LIGHT OUTPUT.
- EASY MOUNTING ON P.C. BOARDS OR SOCKETS.
- CATEGORIZED FOR LUMINOUS INTENSITY.
- MECHANICALLY RUGGED.
- STANDARD: GRAY FACE, WHITE SEGMENT.
- RoHS COMPLIANT.

Description

The Super Bright Red source color devices are made with Gallium Aluminum Arsenide Red Light Emitting Diode.

Package Dimensions & Internal Circuit Diagram

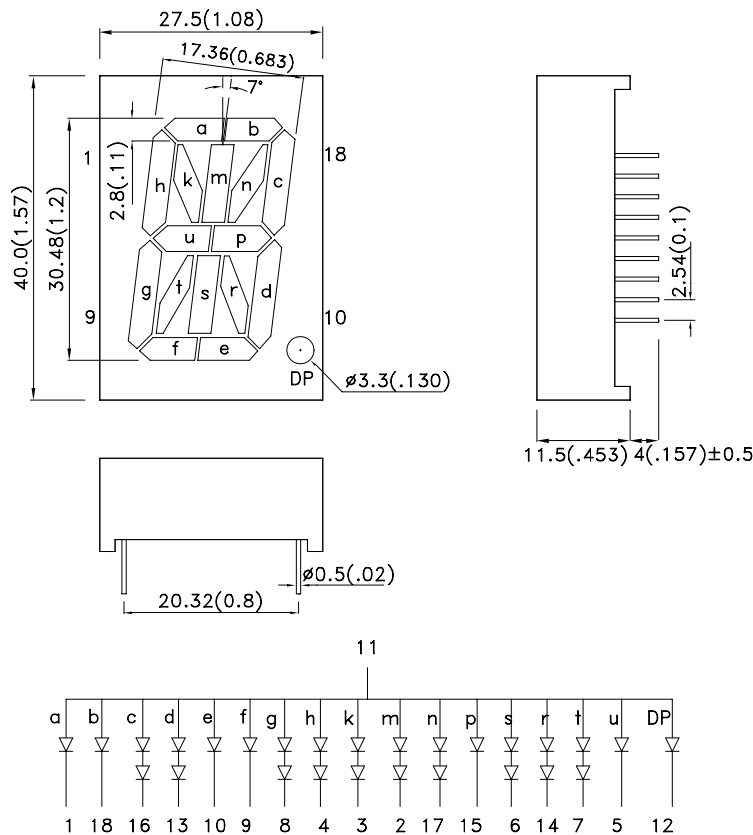

Notes:

1. All dimensions are in millimeters (inches), Tolerance is $\pm 0.25(0.01)$ " unless otherwise noted.
2. Specifications are subject to change without notice.



Selection Guide

Part No.	Dice	Lens Type	Iv (ucd) [1] @ 10mA		Description
			Min.	Typ.	
PSA12-11SRWA	SUPER BRIGHT RED (GaAlAs)	WHITE DIFFUSED	8000	26000	Common Anode, Rt. Hand Decimal

Note:

1. Luminous Intensity/ Luminous Flux: +/-15%.

Electrical / Optical Characteristics at TA=25°C

Symbol	Parameter	Device	Typ.	Max.	Units	Test Conditions
λ_{peak}	Peak Wavelength	Super Bright Red	660		nm	IF=20mA
$\lambda_D[1]$	Dominant Wavelength	Super Bright Red	640		nm	IF=20mA
$\Delta\lambda_{1/2}$	Spectral Line Half-width	Super Bright Red	20		nm	IF=20mA
C	Capacitance	Super Bright Red	45		pF	VF=0V;f=1MHz
VF[2]	Forward Voltage	c,d,g,h,k,m,n,s,r,t	3.7	5.0	V	IF=20mA
		a,b,e,f,p,u and DP	1.85	2.5		
IR	Reverse Current	c,d,g,h,k,m,n,s,r,t		10	uA	VR = 10V
		a,b,e,f,p,u and DP		10		VR = 5V

Notes:

1. Wavelength: +/-1nm.

2. Forward Voltage: +/-0.1V.

Absolute Maximum Ratings at TA=25°C

Parameter	Super Bright Red	Units
Power dissipation	c,d,g,h,k,m,n,s,r,t	150
	a,b,e,f,p,u and DP	75
DC Forward Current	c,d,g,h,k,m,n,s,r,t	30
	a,b,e,f,p,u and DP	30
Peak Forward Current [1]	c,d,g,h,k,m,n,s,r,t	155
	a,b,e,f,p,u and DP	155
Reverse Voltage	c,d,g,h,k,m,n,s,r,t	10
	a,b,e,f,p,u and DP	5
Operating/Storage Temperature	-40°C To +85°C	
Lead Solder Temperature [2]	260°C For 3-5 Seconds	

Notes:

1. 1/10 Duty Cycle, 0.1ms Pulse Width.

2. 2mm below package base.

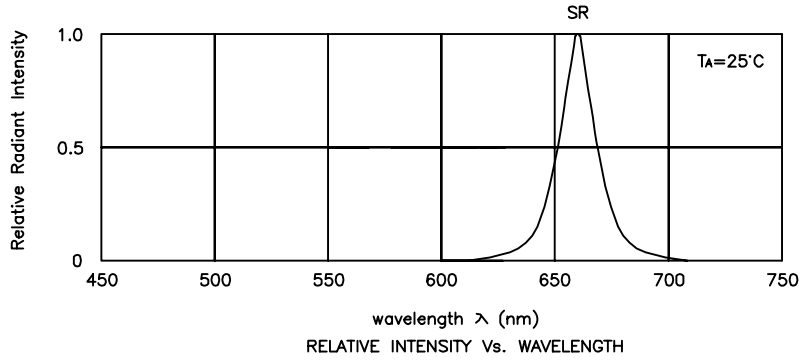

**PSA12-11SRWA
Super Bright Red**

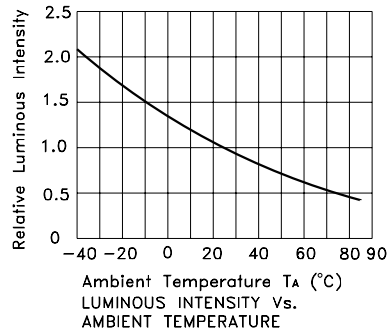
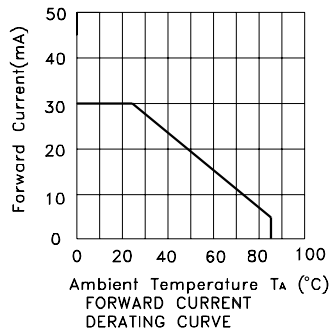
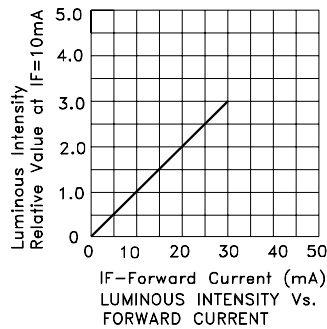
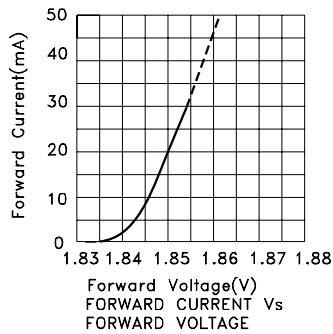

Note: the curves are on the segment a,b,e,f,p,u and DP.

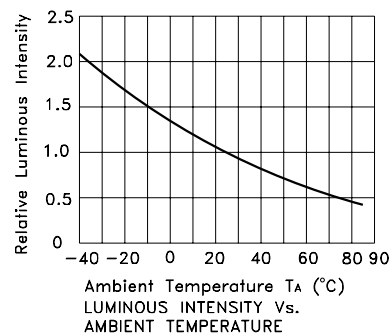
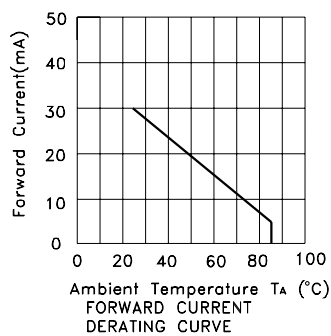
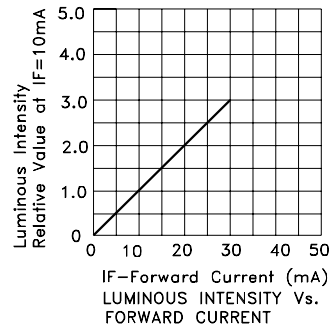
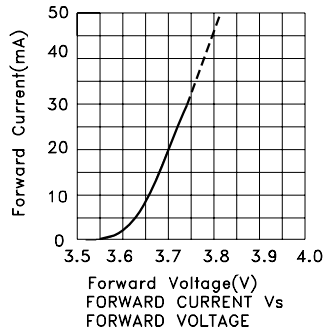

Note:the curves are on the segment c,d,g,h,k,m,n,s,r and t.

PACKING & LABEL SPECIFICATIONS

PSA12-11SRWA

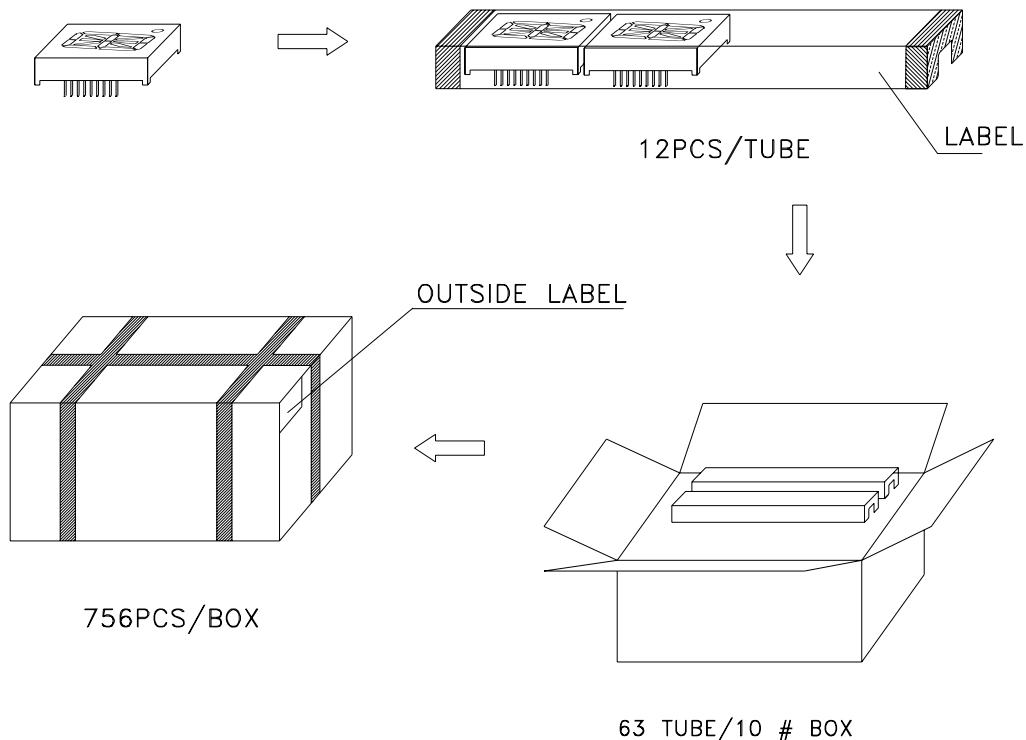

Inside LABEL Paste On The IC-tube

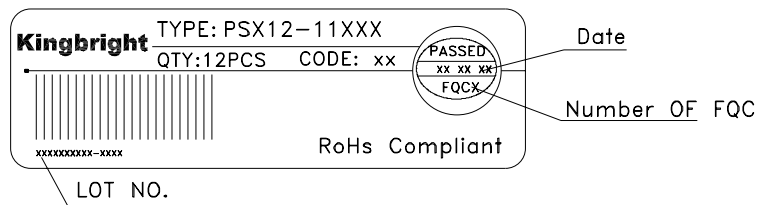

Outside LABEL Paste On The Box

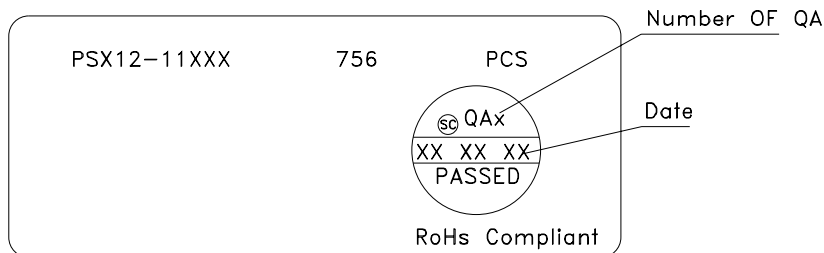

X-ON Electronics

Largest Supplier of Electrical and Electronic Components

Click to view similar products for [LED Displays & Accessories](#) category:

Click to view products by [Kingbright](#) manufacturer:

Other Similar products are found below :

[LTC-4624JD](#) [LTC-4627WC](#) [LTC-571P](#) [LTM-8522G](#) [LTP-4323P](#) [LTP-747G](#) [LTS-3361JG-06](#) [1668](#) [HT-F196NB-5323](#) [IPD2131-27](#) [SA03-12EWA](#) [LDQ-N514RI](#) [LDS-A3506RD](#) [LDS-A3926RI](#) [SC03-12HDB](#) [SI-B9T151550WW](#) [SI-B9V171550WW](#) [SLC-3PF-WL](#) [SLDN-32M-G1624](#) [LTC-2621JD](#) [LTC-2623WC](#) [LTC-4627JD](#) [LTD-322G](#) [LTD-482PC](#) [LTP-1057AHR](#) [LTP-1457AKR](#) [LTP-3784G-01](#) [LTS-313AP](#) [LTS-4812SKR-P](#) [LTS-547AE](#) [LTS-6780P](#) [446010401-3](#) [HV-7W30-6829](#) [DA43-11GWA](#) [LDD-A516RI-17](#) [LDD-E305RI](#) [LDQ-N3402RI](#) [LDQ-N3606RI](#) [LDT-M2804RI](#) [86004CB830](#) [LTP-3862JD](#) [LTP-2088AKD](#) [LTD-6740P](#) [LTS-6880Y](#) [LDS-SMC3002RISUGTR](#) [LTC-2623E](#)
[CC25-12YWA](#) [LDM-6432-P3-UR-1](#) [SR420312N/32](#)