

Part Number: SC04-11GWA

Green

Features

- 0.4 inch digit height.
- Low current operation.
- Excellent character appearance.
- Easy mounting on P.C. boards or sockets.
- Mechanically rugged.
- Standard : gray face, white segment.
- RoHS compliant.

Description

The Green source color devices are made with Gallium Phosphide Green Light Emitting Diode.

Package Dimensions & Internal Circuit Diagram

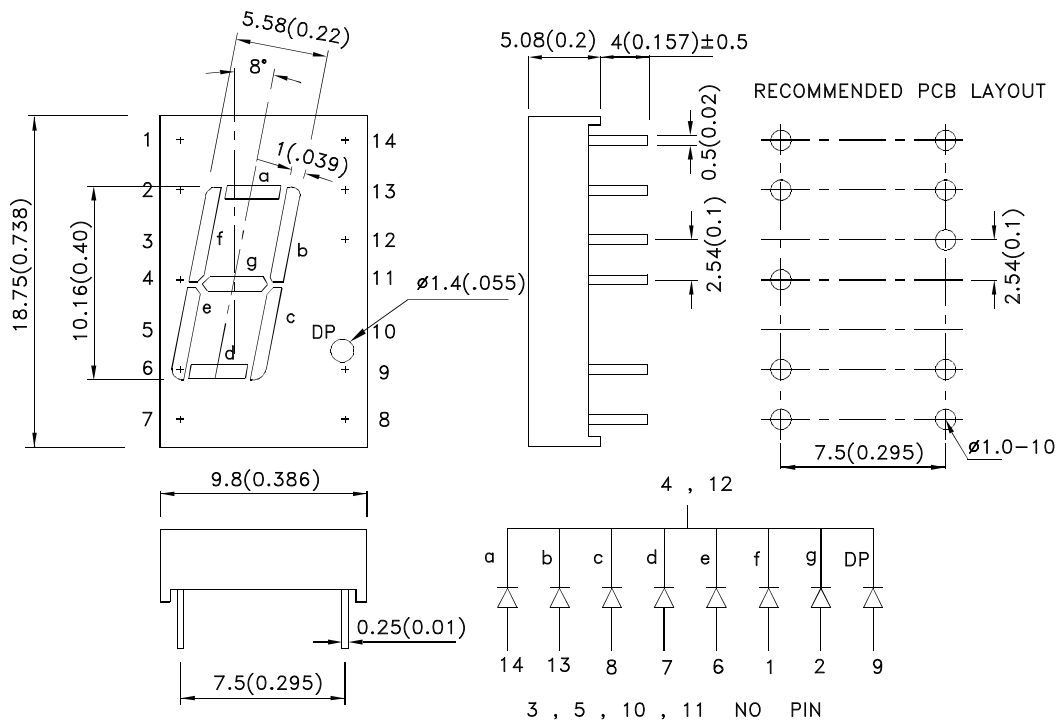

Notes:

1. All dimensions are in millimeters (inches), Tolerance is $\pm 0.25(0.01)$ unless otherwise noted.
2. The specifications, characteristics and technical data described in the datasheet are subject to change without prior notice.



Selection Guide

Part No.	Dice	Lens Type	Iv (ucd) [1] @ 10mA		Description
			Min.	Typ.	
SC04-11GWA	Green (GaP)	White Diffused	3600	8600	Common Cathode, Rt. Hand Decimal.

Note:

1. Luminous intensity/ luminous Flux: +/-15%.

Electrical / Optical Characteristics at TA=25°C

Symbol	Parameter	Device	Typ.	Max.	Units	Test Conditions
λ_{peak}	Peak Wavelength	Green	565		nm	I _F =20mA
λ_D [1]	Dominant Wavelength	Green	568		nm	I _F =20mA
$\Delta\lambda_{1/2}$	Spectral Line Half-width	Green	30		nm	I _F =20mA
C	Capacitance	Green	15		pF	V _F =0V;f=1MHz
V _F [2]	Forward Voltage	Green	2.2	2.5	V	I _F =20mA
I _R	Reverse Current	Green		10	uA	V _R =5V

Notes:

- 1.Wavelength: +/-1nm.
2. Forward Voltage: +/-0.1V.

Absolute Maximum Ratings at TA=25°C

Parameter	Green	Units
Power dissipation	62.5	mW
DC Forward Current	25	mA
Peak Forward Current [1]	140	mA
Reverse Voltage	5	V
Operating / Storage Temperature	-40°C To +85°C	
Lead Solder Temperature[2]	260°C For 3-5 Seconds	

Notes:

1. 1/10 Duty Cycle, 0.1ms Pulse Width.
2. 2mm below package base.



Green

SC04-11GWA

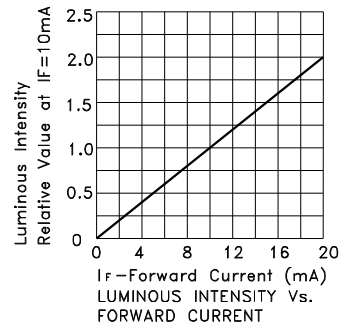

PACKING & LABEL SPECIFICATIONS

SC04-11GWA

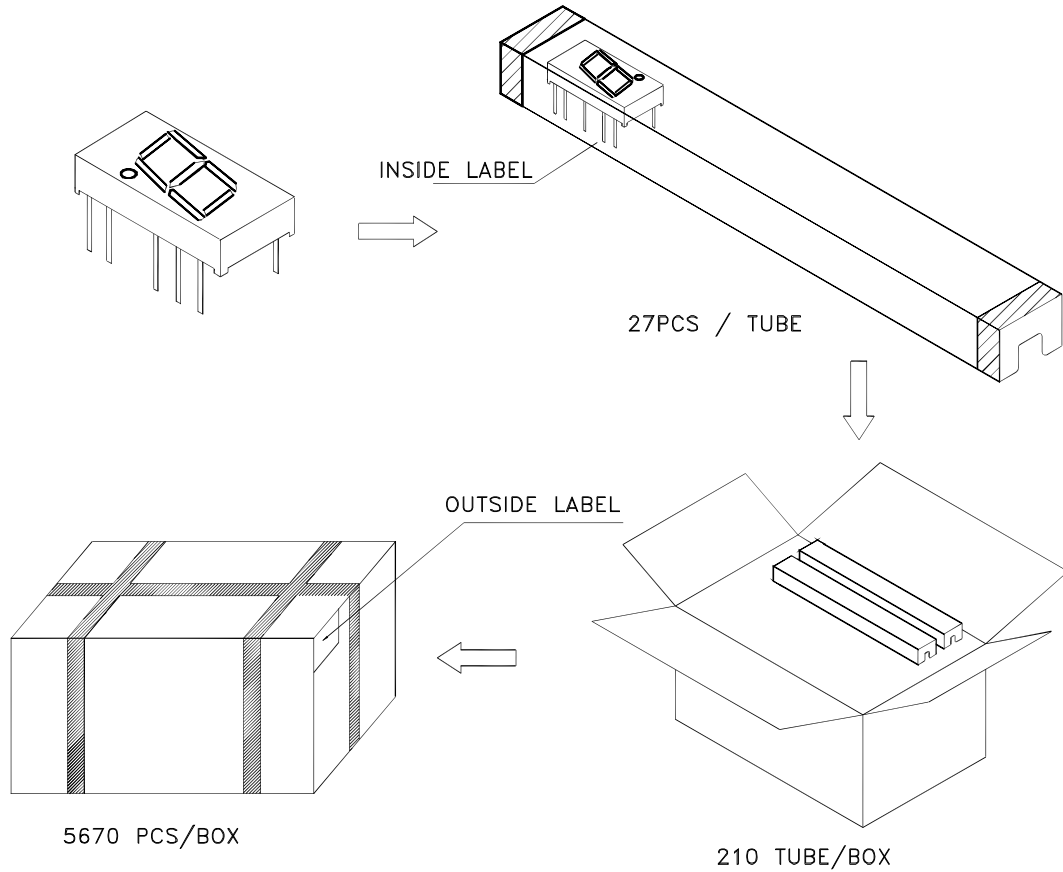

Inside Label On IC-Tube

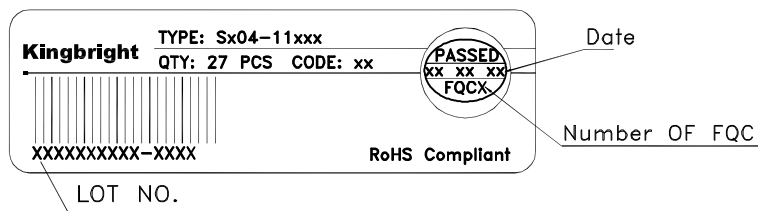

Outside Label On Box

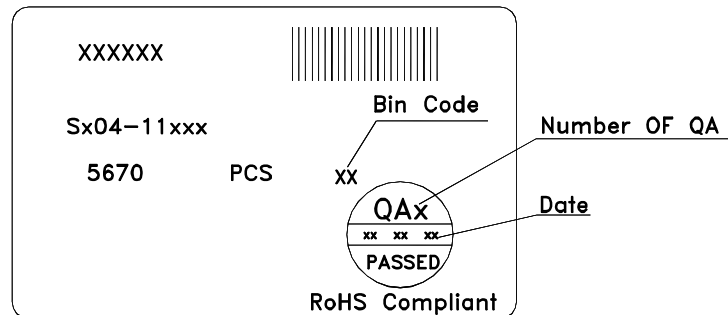

THROUGH HOLE DISPLAY MOUNTING METHOD

Lead Forming

Do not bend the component leads by hand without proper tools.
The leads should be bent by clinching the upper part of the lead firmly such that the bending force is not exerted on the plastic body.



Installation

- 1.The installation process should not apply stress to the lead terminals.
- 2.When inserting for assembly, ensure the terminal pitch matches the substrate board's hole pitch to prevent spreading or pinching the lead terminals.



DISPLAY SOLDERING CONDITIONS

Wave Soldering Profile For Lead-free Through-hole LED.

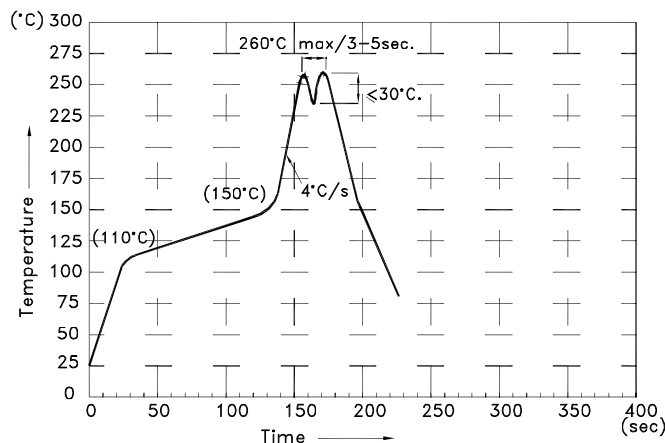

NOTES:

- 1.Recommend the wave temperature 245°C~260°C.The maximum soldering temperature should be less than 260°C.
- 2.Do not apply stress on epoxy resins when temperature is over 85°C.
- 3.The soldering profile apply to the lead free soldering (Sn/Cu/Ag alloy).
- 4.During wave soldering , the PCB top-surface temperature should be kept below 105°C
- 5.No more than once.

Soldering General Notes:

- a. Through-hole displays are incompatible with reflow soldering.
- b. If components will undergo multiple soldering processes, or other processes where the components may be subjected to intense heat, please check with Kingbright for compatibility.

CLEANING

1. Mild "no-clean" fluxes are recommended for use in soldering.
2. If cleaning is required, Kingbright recommends to wash components with water only. Do not use harsh organic solvents for cleaning, because they may damage the plastic parts. And the devices should not be washed for more than one minute.

CIRCUIT DESIGN NOTES

1. Protective current-limiting resistors may be necessary to operate the Displays.
2. LEDs mounted in parallel should each be placed in series with its own current-limiting resistor.

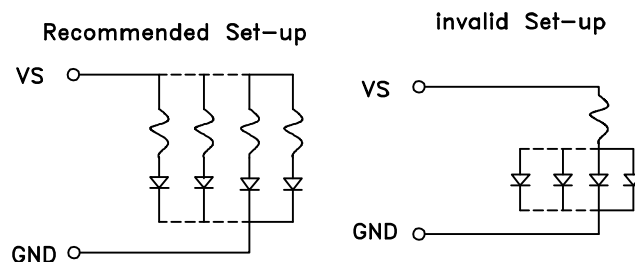

X-ON Electronics

Largest Supplier of Electrical and Electronic Components

Click to view similar products for [LED Displays & Accessories](#) category:

Click to view products by [Kingbright](#) manufacturer:

Other Similar products are found below :

[LTC-4624JD](#) [LTC-4627WC](#) [LTC-571P](#) [LTM-8522G](#) [LTP-4323P](#) [LTP-747G](#) [LTS-3361JG-06](#) [1668](#) [HT-F196NB-5323](#) [IPD2131-27](#) [SA03-12EWA](#) [LDQ-N514RI](#) [LDS-A3506RD](#) [LDS-A3926RI](#) [SC03-12HDB](#) [SI-B9T151550WW](#) [SI-B9V171550WW](#) [SLC-3PF-WL](#) [SLDN-32M-G1624](#) [LTC-2621JD](#) [LTC-2623WC](#) [LTC-4627JD](#) [LTD-322G](#) [LTD-482PC](#) [LTP-1057AHR](#) [LTP-1457AKR](#) [LTP-3784G-01](#) [LTS-313AP](#) [LTS-4812SKR-P](#) [LTS-547AE](#) [LTS-6780P](#) [446010401-3](#) [HV-7W30-6829](#) [DA43-11GWA](#) [LDD-A516RI-17](#) [LDD-E305RI](#) [LDQ-N3402RI](#) [LDQ-N3606RI](#) [LDT-M2804RI](#) [86004CB830](#) [LTP-3862JD](#) [LTP-2088AKD](#) [LTD-6740P](#) [LTS-6880Y](#) [LDS-SMC3002RISUGTR](#) [LTC-2623E](#)
[CC25-12YWA](#) [LDM-6432-P3-UR-1](#) [SR420312N/32](#)