

Part Number: WP819GGD

Green

Features

- UNIFORM LIGHT OUTPUT.
- LOW POWER CONSUMPTION.
- 3 LEADS WITH ONE COMMON CATHODE LEAD.
- I.C. COMPATIBLE.
- LONG LIFE - SOLID STATE RELIABILITY.
- RoHS COMPLIANT.

Description

The Green source color devices are made with Gallium Phosphide Green Light Emitting Diode.

Package Dimensions

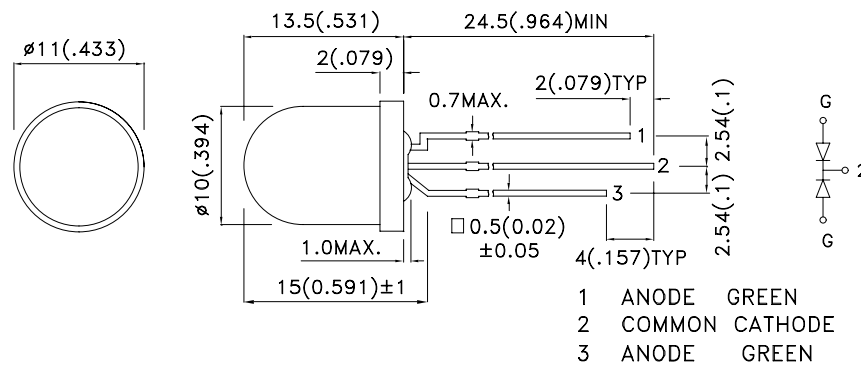

Notes:

1. All dimensions are in millimeters (inches).
2. Tolerance is $\pm 0.25(0.01)$ unless otherwise noted.
3. Lead spacing is measured where the leads emerge from the package.
4. Specifications are subject to change without notice.



Selection Guide

Part No.	Dice	Lens Type	Iv (mcd) [2] @ 20mA		Viewing Angle [1]
			Min.	Typ.	2θ1/2
WP819GGD	Green (GaP)	GREEN DIFFUSED	10	40	50°
	Green (GaP)		10	40	

Notes:

1. θ1/2 is the angle from optical centerline where the luminous intensity is 1/2 the optical centerline value.
2. Luminous intensity/ luminous Flux: +/-15%.

Electrical / Optical Characteristics at TA=25°C

Symbol	Parameter	Device	Typ.	Max.	Units	Test Conditions
λ _{peak}	Peak Wavelength	Green	565		nm	I _F =20mA
λ _D [1]	Dominant Wavelength	Green	568		nm	I _F =20mA
Δλ _{1/2}	Spectral Line Half-width	Green	30		nm	I _F =20mA
C	Capacitance	Green	15		pF	V _F =0V;f=1MHz
V _F [2]	Forward Voltage	Green	2.2	2.5	V	I _F =20mA
I _R	Reverse Current	Green		10	uA	V _R = 5V

Notes:

1. Wavelength: +/-1nm.
2. Forward Voltage: +/-0.1V.

Absolute Maximum Ratings at TA=25°C

Parameter	Green	Units
Power dissipation	62.5	mW
DC Forward Current	25	mA
Peak Forward Current [1]	140	mA
Reverse Voltage	5	V
Operating/Storage Temperature	-40°C To +85°C	
Lead Solder Temperature [2]	260°C For 3 Seconds	
Lead Solder Temperature [3]	260°C For 5 Seconds	

Notes:

1. 1/10 Duty Cycle, 0.1ms Pulse Width.
2. 2mm below package base.
3. 5mm below package base.



Green

WP819GGD

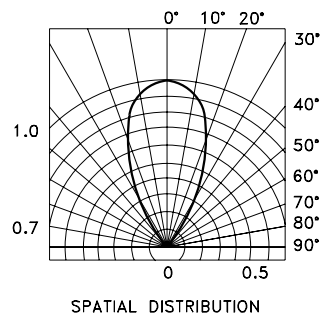
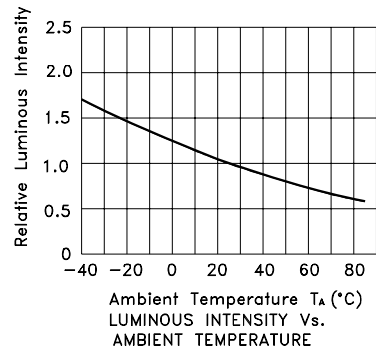
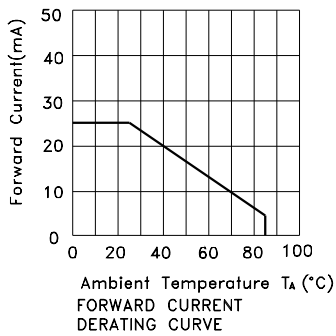
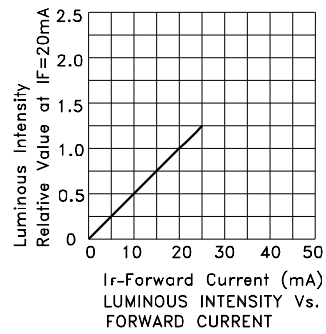
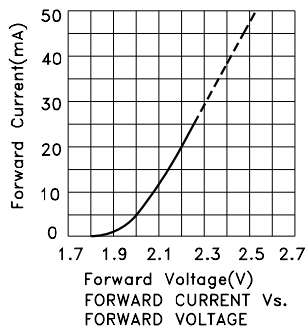

PACKING & LABEL SPECIFICATIONS

WP819GGD

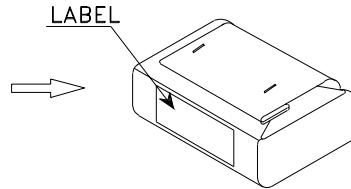
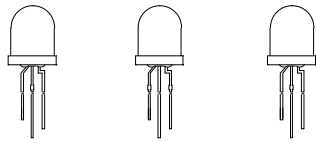

200PCS / BAG



8K / 9# BOX

OUTSIDE LABEL

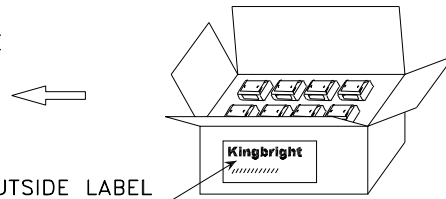

1K / 1# BOX

Kingbright				
Q.C.	<table border="1"> <tr> <td style="text-align: center;">QC</td> </tr> <tr> <td style="text-align: center;">XX XX XXXX</td> </tr> <tr> <td style="text-align: center;">PASSED</td> </tr> </table>	QC	XX XX XXXX	PASSED
QC				
XX XX XXXX				
PASSED				
TYPE NO :	WP819XXX			
QUANTITY :	200 pcs			
S/N :	XXX			
CODE:	XXX			
LOT NO:	 <small>xx-LDPxxx</small>			
RoHS Compliant				

LED MOUNTING METHOD

1. The lead pitch of the LED must match the pitch of the mounting holes on the PCB during component placement. Lead-forming may be required to insure the lead pitch matches the hole pitch. Refer to the figure below for proper lead forming procedures.

(Fig. 1)

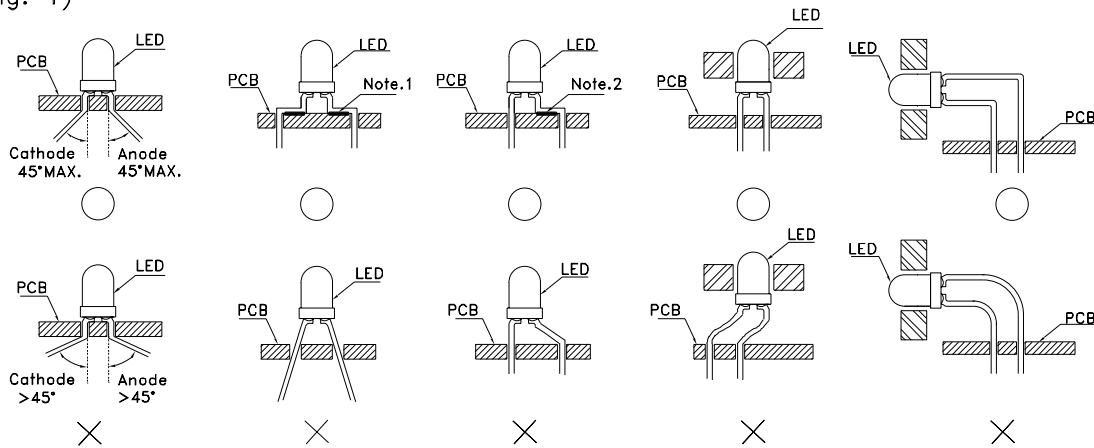

Fig.1

”○” Correct mounting method ”×” Incorrect mounting method

Note 1-2 : Do not route PCB trace in the contact area between the leadframe and the PCB to prevent short-circuits.

2. When soldering wire to the LED, use individual heat-shrink tubing to insulate the exposed leads to prevent accidental contact short-circuit.

(Fig. 2)

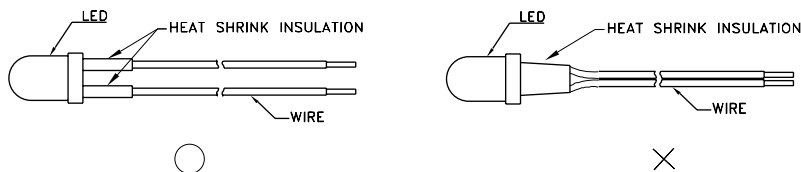

Fig. 2

3. Use stand-offs (Fig. 3) or spacers (Fig. 4) to securely position the LED above the PCB.

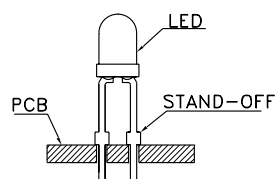

Fig. 3

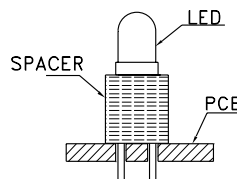

Fig. 4

LEAD FORMING PROCEDURES

1. Maintain a minimum of 2mm clearance between the base of the LED lens and the first lead bend. (Fig. 5 and 6)



Fig. 5



Fig. 6

2. Lead forming or bending must be performed before soldering, never during or after Soldering.
3. Do not stress the LED lens during lead-forming in order to fractures in the lens epoxy and damage the internal structures.
4. During lead forming, use tools or jigs to hold the leads securely so that the bending force will not be transmitted to the LED lens and its internal structures. Do not perform lead forming once the component has been mounted onto the PCB. (Fig. 7)
5. Do not bend the leads more than twice. (Fig. 8)



Fig. 7



Fig. 8

6. After soldering or other high-temperature assembly, allow the LED to cool down to 50°C before applying outside force (Fig. 9). In general, avoid placing excess force on the LED to avoid damage. For any questions please consult with Kingbright representative for proper handling procedures.

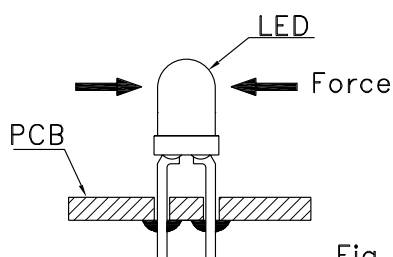

Fig. 9

X-ON Electronics

Largest Supplier of Electrical and Electronic Components

Click to view similar products for [Standard LEDs - Through Hole category](#):

Click to view products by [Kingbright manufacturer](#):

Other Similar products are found below :

[LTL-10254W](#) [LTL-1214A](#) [LTL-2231AT](#) [LTL-3251A](#) [LTL-4262N](#) [LTL-433P](#) [LTL-5234](#) [LTL87HTBK](#) [LTL-87HD4B](#) [HLMP-EL30-PS0DD](#) [1L0532V23G0TD001](#) [NSPW500CS](#) [NTE30036](#) [NTE30044](#) [NTE30059](#) [NTE3020](#) [LD CQDP-1U3U-W5-1-K](#) [LP379PPG1C0G0300001](#) [SLR-342MC3F](#) [SLX-LX3044GD](#) [SLX-LX3044ID](#) [SLX-LX3044YD](#) [1.90690.3330000](#) [SSS-LX4673ID-410B](#) [1L0532Y24I0TD001](#) [264-7SYGD/S530-E2](#) [HLMP-1301-G00FG](#) [HLMP1385](#) [LTL-10224W](#) [LTL-1224A](#) [LTL-1234A](#) [LTL-2251AT](#) [LTL-403HR](#) [LTL-4222](#) [LU7-E-B](#) [4380H1](#) [HLMP-3962-F0002](#) [HLMP-GG15-R0000](#) [323-2SURD/S530-A3](#) [L53SRC/E-Z](#) [L-7679C1ZGC](#) [4302T1-5V](#) [4306D23](#) [4363D1/5](#) [WP1503SRC/J4](#) [WP153GDT](#) [WP153YDT](#) [WP1543SGC](#) [WP1543SURC](#) [WP53MGD](#)