

3
2
1

ZONE REV. DESCRIPTION APPROVAL DATE

RoHS
Compliant

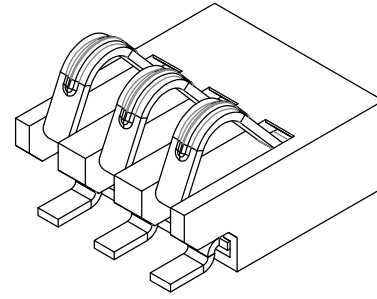

性能:

额定电流: 1.0A
 额定电压: 12V
 耐电压: 500V
 接触电阻: 30mΩ MAX
 绝缘电阻: 500MΩ
 工作温度: -40℃~+85℃
 塑件(材质): LCP E130I
 接触点(材质): 铜合金, 触点镀金3u"

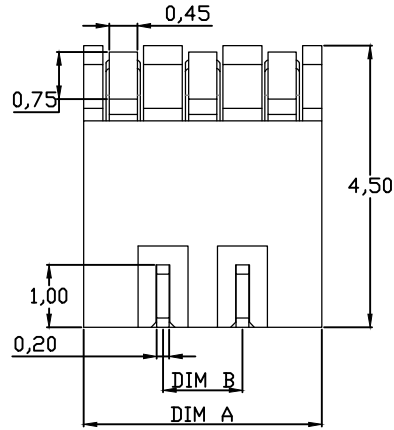
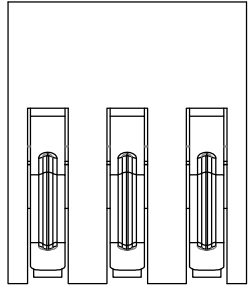

PART NO.	DIM A	DIM B
KH-12701-2P225		2.54
KH-12701-3P225		3.81
KH-12701-4P225	5.08	2.54
KH-12701-5P225	6.35	3.81
KH-12701-6P225	7.62	5.08

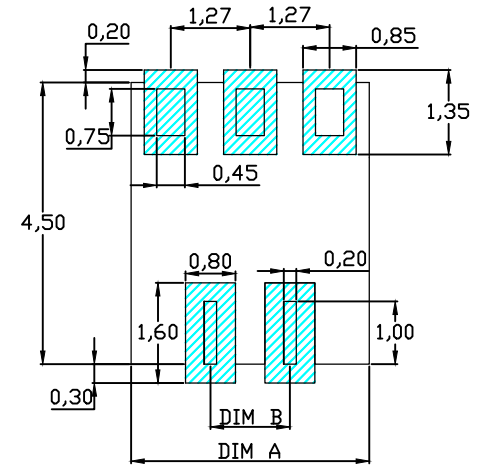
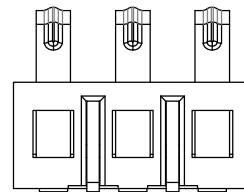
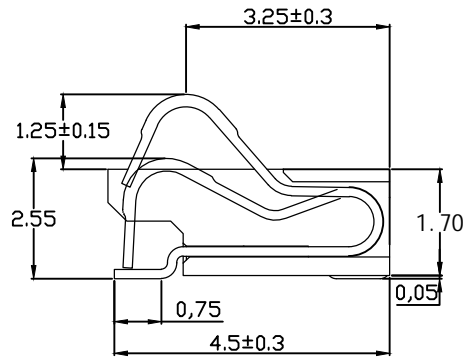
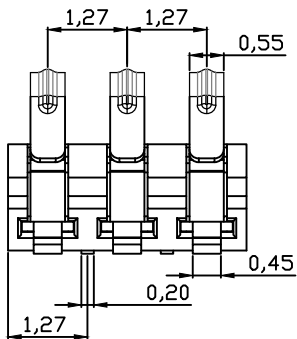

RECOMMENDED PCB LAYOUT

TOP VIEW (. XX ± 0.05)

深圳市金航标电子有限公司

www.kinghelm.com.cn

DESIGN X. Z. Huang

SCALE



TOLERANCE

PART NAME

电池座

KH-12701-5P170

0755-28190160

DRAWING

X. Z. Huang

UNIT

mm



X. ±0.35

PART NO.

KH-12701系列

CHECK

X. X. Zheng

SIZE

A4:210:297

X. X ±0.25

DWG. NO.

RBD-SP-0019

APPROVAL

M. Y. Li

VER.

01

ANGLE ±3°

DATE

2019-11-04

1

2

3

4

5

6

X-ON Electronics

Largest Supplier of Electrical and Electronic Components

Click to view similar products for [Coin Cell Battery Holders](#) category:

Click to view products by [Kingham](#) manufacturer:

Other Similar products are found below :

[PDSN-11-D](#) [799-2007](#) [BH44AAB](#) [BH48DL](#) [BH8000](#) [MY-2430-01-R](#) [BS-16-B4AA006-R](#) [KH-CR1220-2](#) [BH-18650-A1AJ006](#) [BS-02-A1BK007](#) [BH-18650-A1AJ005](#) [BS-12-B3AA009-R](#) [BS-02-A1AK010-X](#) [BS-02-A1AJ010](#) [BS-03-A1AJ001](#) [MY-FJ-131-J-R](#) [MY-FJ-04-J-R](#) [BS-08-B2AA025](#) [BS-24-A1AJ017](#) [BH-18650-A5BJ001-2D](#) [BS-12-A1AJ002-Z](#) [BS-08-B2AA032](#) [MY-2032-04-R](#) [BS-12-B3AA011-R](#) [BS-621-B4AA001-R](#) [MY-ZJ-110](#) [MY-FJ-127-R](#) [BS-06-B4AA002-R](#) [MY-1220-04](#) [BH-AAA-A1AJ001](#) [BS-12-B3AA003-T](#) [MY-FJ-115II-R](#) [BS-06-B4AK001-R](#) [BH-18650-B1BA007](#) [MY-FJ-115II](#) [BH-AAA-B5AA001](#) [BE-13-017](#) [MY-2477-01](#) [BS-12-B3AA013](#) [BC-25-5PD-300](#) [BS-08-B2AA016-R](#) [MY-AAA-22-J](#) [MY-AA-14-J](#) [MY-AAA-24-J](#) [MY-2032-28](#) [BS-06-A4BK016](#) [MY-FJ-01](#) [MY-1025-01](#) [MY-AA-5355-J](#) [BS-05-A1BJ018](#)