

RoHS
Compliant

性能:

额定电流: 2.0A
 额定电压: 12V
 耐电压: 500V
 接触电阻: 30mΩ MAX
 绝缘电阻: 500MΩ
 工作温度: -55℃~+125℃
 使用寿命: 5000次以上
 塑件(材质): LCP黑色 耐高温260度
 接触点(材质): 黄铜C2680, 接触面镀金3U"

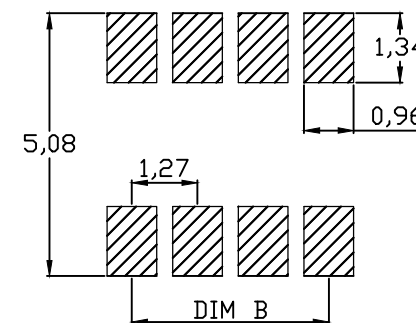
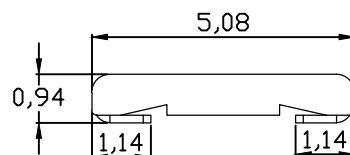
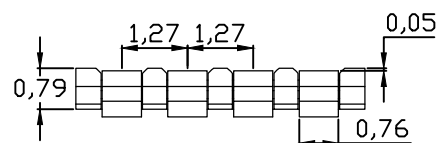
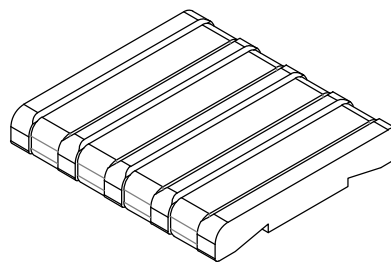
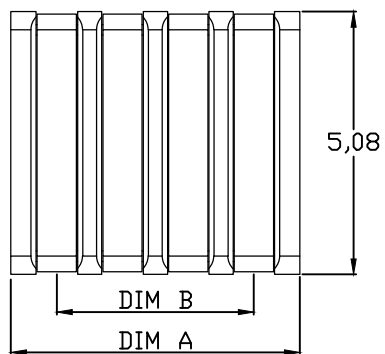

RECOMMENDED PCB LAYOUT
TOP VIEW (.XX±0.05)

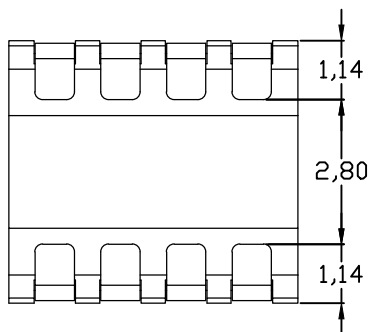

规格型号	DIM A	DIM B
KH-12702-2P094	3.05	1.27
KH-12702-3P094	4.32	2.54
KH-12702-4P094	5.59	3.81
KH-12702-5P094	6.86	5.08
KH-12702-6P094	8.13	6.35

深圳市金航标电子有限公司 www.kinghelm.com.cn

KH-12702-5P094

0755-28190160

DESIGN	X. Z. Huang	SCALE		
DRAWING	X. Z. Huang	UNIT	mm	
CHECK	X. X. Zheng	SIZE	A4:210:297	
APPROVAL	M. Y. Li	VER.	01	

TOLERANCE	
X.	±0.35
X.X	±0.25
X.XX	±0.15
ANGLE	±3°

PART NAME	电池座
PART NO.	BC-12702系列
DWG. NO.	
DATE	2019-11-04

X-ON Electronics

Largest Supplier of Electrical and Electronic Components

Click to view similar products for [Coin Cell Battery Holders](#) category:

Click to view products by [Kingham](#) manufacturer:

Other Similar products are found below :

[PDSN-11-D](#) [799-2007](#) [BH44AAB](#) [BH48DL](#) [BH8000](#) [MY-2430-01-R](#) [BS-16-B4AA006-R](#) [KH-CR1220-2](#) [BH-18650-A1AJ006](#) [BS-02-A1BK007](#) [BH-18650-A1AJ005](#) [BS-12-B3AA009-R](#) [BS-02-A1AK010-X](#) [BS-02-A1AJ010](#) [BS-03-A1AJ001](#) [MY-FJ-131-J-R](#) [MY-FJ-04-J-R](#) [BS-08-B2AA025](#) [BS-24-A1AJ017](#) [BH-18650-A5BJ001-2D](#) [BS-12-A1AJ002-Z](#) [BS-08-B2AA032](#) [MY-2032-04-R](#) [BS-12-B3AA011-R](#) [BS-621-B4AA001-R](#) [MY-ZJ-110](#) [MY-FJ-127-R](#) [BS-06-B4AA002-R](#) [MY-1220-04](#) [BH-AAA-A1AJ001](#) [BS-12-B3AA003-T](#) [MY-FJ-115II-R](#) [BS-06-B4AK001-R](#) [BH-18650-B1BA007](#) [MY-FJ-115II](#) [BH-AAA-B5AA001](#) [BE-13-017](#) [BS-12-B3AA013](#) [BC-25-5PD-300](#) [BS-08-B2AA016-R](#) [MY-AAA-22-J](#) [MY-AA-14-J](#) [MY-AAA-24-J](#) [MY-2032-28](#) [BS-06-A4BK016](#) [MY-FJ-01](#) [MY-1025-01](#) [MY-AA-5355-J](#) [BS-05-A1BJ018](#) [MY-2032-25-R](#)