

# 深圳市金航标电子有限公司

## Product specification

Drawing No. : KH-2FK1-D-SM-101

### Series description

FAKRA connectors are designed to perform up to 6 GHz and meet the particular mechanical and environmental requirements of the automobile industry. This connector is designed to meet or exceed the requirement of specification for automotive RF connector systems. Interface is designed to meet DIN 72594-1 and automotive electrical & RF connector systems meet SAE/USCAR-2 & SAE/USCAR-17 performance specification.

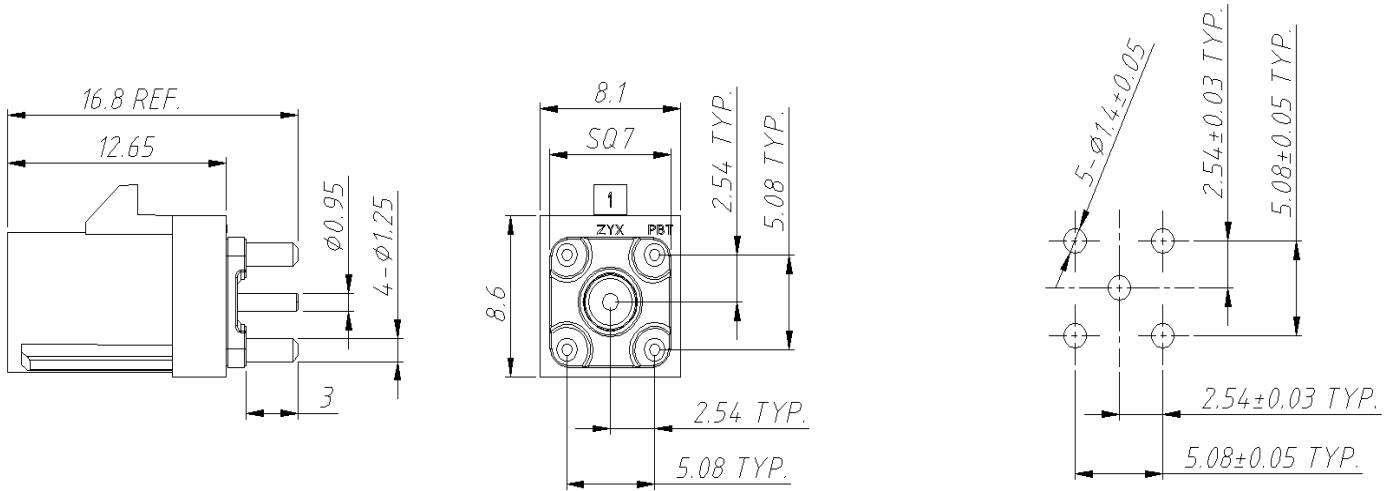

RECOMMENDED PCB LAYOUT

### Electrical data

|  |  |
|--|--|
| 1) Impedance                           | 50 $\Omega$ , Nominal  |
| 2) Frequency range                     | DC-6 GHz   |
| 3) VSWR(Return loss)                   | DC-2 GHz $\leq 1.4$ (15.56 dB)<br>2-3 GHz $\leq 1.5$ (13.98 dB)<br>3-6 GHz $\leq 1.6$ (12.74 dB) |
| 4) Dielectric withstanding voltage     | 800 V rms, Min.  |
| 5) Insulation resistance               | $\geq 100$ M $\Omega$  |
| 6) Contact resistance                  |  |
| Original state                         | $\leq 10$ m $\Omega$   |
| After endurance or environmental tests | $\leq 40$ m $\Omega$   |

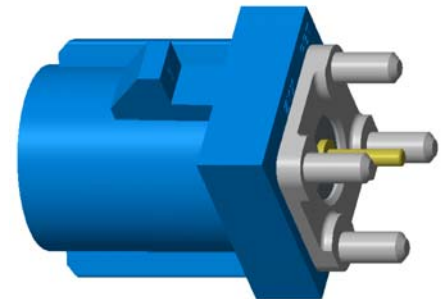

### Mechanical data

|                            |                |
|----------------------------|----------------|
| 1) Outline dimensions      | Per Drawing    |
| 2) Durability              | 25 Cycles Min. |
| 3) Meet USCAR-2 & USCAR-17 |                |

### Material and finish

| Component description | Material   | Finish         |
|-----------------------|------------|----------------|
| 1) Housing            | PBT        | Per key code   |
| 2) Body               | Zinc alloy | Nickel plating |
| 3) Insulator          | PTFE       | Natural        |
| 4) Contact pin        | Brass      | Au plating     |

|              |  |                   |                  |          |       |
|--------------|--|-------------------|------------------|----------|-------|
| 深圳市金航标电子有限公司 |  | TITLE             | DATE             | 2020-7-2 |       |
|              |  | FAKRA PCB VT PLUG |                  | CREATED  | ERIC  |
|              |  |                   | CHECKED          | FANCY    |       |
| ECN          |  | P/N               | KH-2FK1-D-SM-101 | APPROVED | JASON |
| DATE         |  | SHEET             | 1 OF 2           | REV.     | A1    |

**Product specification****Drawing No. : KH-2FK1-D-SM-101****Environmental data**













|                                 |                           |                                 |
|---------------------------------|---------------------------|---------------------------------|
| 1) Temperature range            | -40 °C To 105 °C          |                                 |
| 2) RoHS compliant               | Yes                       |                                 |
| 3) Thermal shock                | USCAR-17, Paragraph 4.5.1 | -40 °C To 85 °C, 100 Cycles     |
| 4) Vibration & Mechanical shock | USCAR-2, Paragraph 5.4.6  | Random, 5-10 ms, 35Gs, 1/2 sine |
| 5) Temperature/Humidity cycling | USCAR-2, Paragraph 5.6.2  | 40 Cycles, 8 Hours/Cycle        |

**Other**

2FK1-X-SM-101: "X" Show key code

Key code see: FK-PLUG-KCX

**Key code**

| KEY CODE  | PART NO.      | COLOR          | RAL  |
|---|---------------|----------------|------|
|  A   | 2FK1-A-SM-101 | JET BLACK      | 9005 |
|  B   | 2FK1-B-SM-101 | CREAM WHITE    | 9001 |
|  C  | 2FK1-C-SM-101 | SIGNAL BLUE    | 5005 |
|  D | 2FK1-D-SM-101 | CLARET VIOLET  | 4004 |
|  E | 2FK1-E-SM-101 | LEAF GREEN     | 6002 |
|  F | 2FK1-F-SM-101 | NUT BROWN      | 8011 |
|  G | 2FK1-G-SM-101 | BLUE GREY      | 7031 |
|  H | 2FK1-H-SM-101 | HEATHER VIOLET | 4003 |
|  I | 2FK1-I-SM-101 | BEIGE          | 1001 |
|  K | 2FK1-K-SM-101 | CURRY          | 1027 |
|  L | 2FK1-L-SM-101 | CARMIN RED     | 3002 |
|  M | 2FK1-M-SM-101 | PASTEL ORANGE  | 2003 |
|  N | 2FK1-N-SM-101 | PASTEL GREEN   | 6019 |
|  Z | 2FK1-Z-SM-101 | WATER BLUE     | 5021 |

|              |  |                   |                  |          |          |
|--------------|--|-------------------|------------------|----------|----------|
| 深圳市金航标电子有限公司 |  | TITLE             |                  | DATE     | 2020-7-2 |
|              |  | FAKRA PCB VT PLUG |                  | CREATED  | ERIC     |
| ECO          |  |                   |                  | CHECKED  | FANCY    |
| ECN          |  | P/N               | KH-2FK1-D-SM-101 | APPROVED | JASON    |
| DATE         |  | SHEET             | 2 OF 2           | REV.     | A1       |

## X-ON Electronics

Largest Supplier of Electrical and Electronic Components

*Click to view similar products for [Standard Circular Connector](#) category:*

*Click to view products by [Kinghelm](#) manufacturer:*

Other Similar products are found below :

[600273N007](#) [6134-336-13149](#) [6134-337-11149](#) [6134-337-2390](#) [6134-341-17149](#) [67-02E12-60PX](#) [680-SMG](#) [CXS3102A181S](#)  
[D38999/20FC8SA L/C](#) [75-190216-08S](#) [75-190611-03S](#) [75-474014-05S](#) [75-474618-04S](#) [75-474620-07P](#) [799539-000](#) [805-005-07NF11-19PC](#)  
[805-005-07NF15-7PA](#) [FMP.2M.310.XLCT](#) [836783-1](#) [862256-1](#) [866857-1](#) [867865-1](#) [PT08P-14-19S](#) [PT08P-14-5S](#) [QCM019PC2DC012B](#)  
[121583-0217](#) [121667-0020](#) [RD10A16-19-P6CS051/1](#) [RD16A14-12-S6CS051/2](#) [1301240268](#) [1301240275](#) [1301860906](#) [DCU-08BFEA-](#)  
[LL7001](#) [RM15WTP-CP\(5\)\(71\)](#) [14482](#) [16283-18](#) [1877910-1](#) [206039-3](#) [206323-1](#) [207002-2](#) [207682-1](#) [CA06COME14SA7P](#) [211777-1](#) [JL04-](#)  
[1012CK\(05\)-R](#) [JL04V-2A28-11PE-R](#) [JL04V-2E10SL-3PE-B-R](#) [JL04V-2E20-15PE-B-R](#) [JL04V-2E20-4PE-B-R](#) [JL04V-2E24-10PE\(G\)-B-R](#)  
[JL04V-6A24-11SE-EB-R](#)