

# 深圳市金航标电子有限公司

## Product specification

Drawing No. : KH-2FK1-I-SM-101

### Series description

FAKRA connectors are designed to perform up to 6 GHz and meet the particular mechanical and environmental requirements of the automobile industry. This connector is designed to meet or exceed the requirement of specification for automotive RF connector systems. Interface is designed to meet DIN 72594-1 and automotive electrical & RF connector systems meet SAE/USCAR-2 & SAE/USCAR-17 performance specification.

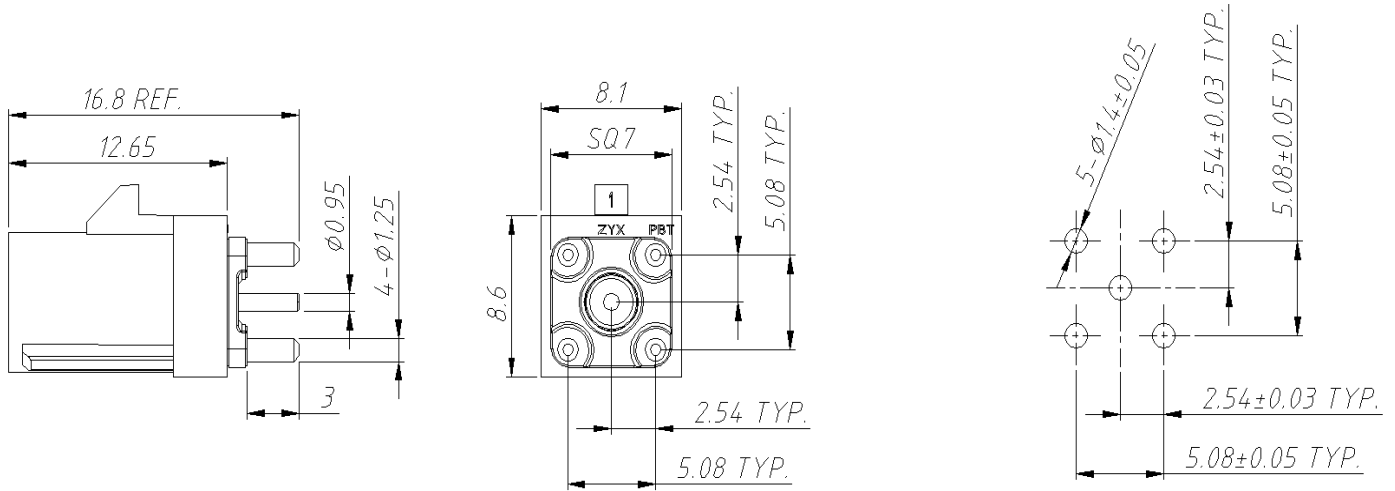

RECOMMENDED PCB LAYOUT

### Electrical data

1) Impedance	50 Ω, Nominal
2) Frequency range	DC-6 GHz
3) VSWR(Return loss)	DC-2 GHz ≤ 1.4 (15.56 dB) 2-3 GHz ≤ 1.5 (13.98 dB) 3-6 GHz ≤ 1.6 (12.74 dB)
4) Dielectric withstanding voltage	800 V rms, Min.
5) Insulation resistance	≥ 100 MΩ
6) Contact resistance	
Original state	≤ 10 mΩ
After endurance or environmental tests	≤ 40 mΩ

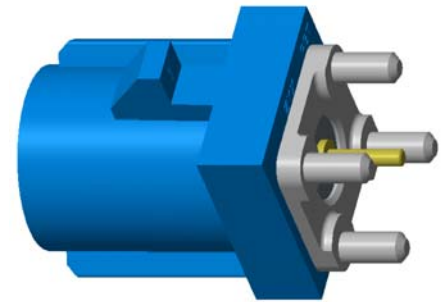

### Mechanical data

1) Outline dimensions	Per Drawing
2) Durability	25 Cycles Min.
3) Meet USCAR-2 & USCAR-17	

### Material and finish

Component description	Material	Finish
1) Housing	PBT	Per key code
2) Body	Zinc alloy	Nickel plating
3) Insulator	PTFE	Natural
4) Contact pin	Brass	Au plating

深圳市金航标电子有限公司		TITLE		DATE	
		FAKRA PCB VT PLUG		2020-7-2	
				CREATED	
				ERIC	
				CHECKED	
				FANCY	
ECN		P/N		APPROVED	
		KH-2FK1-I-SM-101		JASON	
DATE		SHEET		REV.	
		1 OF 2		A1	

**Product specification****Drawing No. : KH-2FK1-I-SM-101****Environmental data**













1) Temperature range	-40 °C To 105 °C	
2) RoHS compliant	Yes	
3) Thermal shock	USCAR-17, Paragraph 4.5.1	-40 °C To 85 °C, 100 Cycles
4) Vibration & Mechanical shock	USCAR-2, Paragraph 5.4.6	Random, 5-10 ms, 35Gs, 1/2 sine
5) Temperature/Humidity cycling	USCAR-2, Paragraph 5.6.2	40 Cycles, 8 Hours/Cycle

**Other**

2FK1-X-SM-101: "X" Show key code

Key code see: FK-PLUG-KCX

**Key code**

KEY CODE	PART NO.	COLOR	RAL
 A	2FK1-A-SM-101	JET BLACK	9005
 B	2FK1-B-SM-101	CREAM WHITE	9001
 C	2FK1-C-SM-101	SIGNAL BLUE	5005
 D	2FK1-D-SM-101	CLARET VIOLET	4004
 E	2FK1-E-SM-101	LEAF GREEN	6002
 F	2FK1-F-SM-101	NUT BROWN	8011
 G	2FK1-G-SM-101	BLUE GREY	7031
 H	2FK1-H-SM-101	HEATHER VIOLET	4003
 I	2FK1-I-SM-101	BEIGE	1001
 K	2FK1-K-SM-101	CURRY	1027
 L	2FK1-L-SM-101	CARMIN RED	3002
 M	2FK1-M-SM-101	PASTEL ORANGE	2003
 N	2FK1-N-SM-101	PASTEL GREEN	6019
 Z	2FK1-Z-SM-101	WATER BLUE	5021

深圳市金航标电子有限公司		TITLE		DATE	2020-7-2
		FAKRA PCB VT PLUG		CREATED	ERIC
ECO				CHECKED	FANCY
ECN		P/N	KH-2FK1-I-SM-101	APPROVED	JASON
DATE		SHEET	2 OF 2	REV.	A1

## X-ON Electronics

Largest Supplier of Electrical and Electronic Components

*Click to view similar products for [RF Connectors](#) / [Coaxial Connectors](#) category:*

*Click to view products by [Kinghelm](#) manufacturer:*

Other Similar products are found below :

[89674-0827](#) [6059674-1](#) [630059-000](#) [6501-1071-002](#) [6769](#) [7002-1541-010](#) [7002-1572-002](#) [7004-1512-000](#) [7009-1511-004](#) [7101-1541-010](#)  
[7101-1571-002](#) [7105-1521-002](#) [7145-1521-002](#) [7203-1571-003](#) [7209-1511-011](#) [7210-1511-040](#) [7242-1511-000](#) [7405-1521-005](#) [7405-1521-](#)  
[802](#) [804S01D04M040](#) [8527](#) [8547](#) [FS11V](#) [877931](#) [8808-1511-001](#) [9049-9513-000](#) [9074-9513-000](#) [PL11C-026](#) [PL40-36](#) [9408-1113-000](#)  
[980-8666-005](#) [11 SMA-50-2-6 / 111 NE](#) [11 SMA-50-3-6 / 111 NE](#) [11 SMA-50-2-6/111 NH](#) [1-201144-1](#) [120919](#) [R107003010W](#) [R112186000](#)  
[R113053000W](#) [R113082097](#) [R113236000](#) [R114083000](#) [R114670000W](#) [R123415000W](#) [R124072220W](#) [R124076320](#) [R124076450](#)  
[R124175123](#) [R124176123W](#) [R125075000W](#)