

RoHS 2.0

REV.	ECN NO.	DESCRIPTION	DATE	DESIGN
A1.	/.	重新核对图面	21.01.14	LiHui

PIN NUMBER	SIGNAL NAME
PIN 1	Vbus
PIN 2	D-
PIN 3	D+
PIN 4	GND
PIN 5	StdA_SSRX-
PIN 6	StdA_SSRX+
PIN 7	GND_DRAIN
PIN 8	StdA_SSTX-
PIN 9	StdA_SSTX+
SHELL	GND

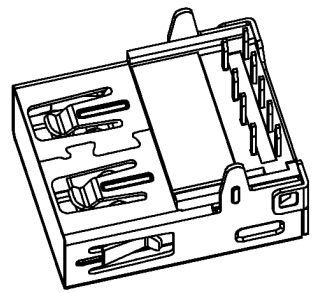

- NOTES:
- MATERIAL:
 - HOUSING: PBT ,COLOR IS BLUE;
 - CONTACT: BRASS (H65 T=0.20&0.25mm);
 - SHELL: COLD ROLLED IRON (SPCC T=0.30mm);
 - ELECTRICAL:
 - VOLTAGE RATING: 30V DC ;
 - CURRENT RATING: 1.5A ;
 - CONTACT RESISTANCE: 30MILLIOHMS MAX.;
 - WITHSTAND VOLTAGE: 100V AC RMS 50(60)Hz,1MIN.;
 - INSULATION RESISTANCE: 100MEGOHMS MIN @500V DC;
 - MECHANICAL:
 - MATING FORCE: 35N MAX.;
 - UNMATING FORCE: 5~35N ;
 - OPERATING LIFE: 1500 CYCLES MIN.;
 - PLATING:
 - TERMINAL:
 - NI PLATING OVER ALL,
 - Tin PLATING ON SOLDER AREA,
 - Au G/Fu" ON CONTACT AREA;
 - SHELL: NI PLATING OVER ALL;
 - ENVIRONMENTAL:
 - STORAGE TEMPERATURE RANGE: -40°C~+85°C;
 - OPERATION TEMPERATURE RANGE: -25°C~+70°C;

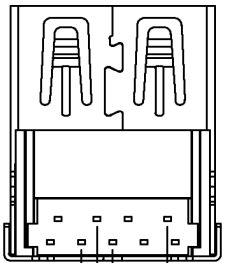
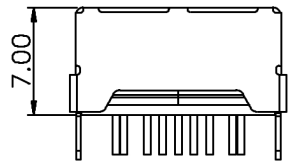
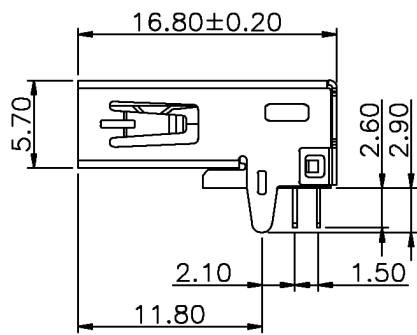
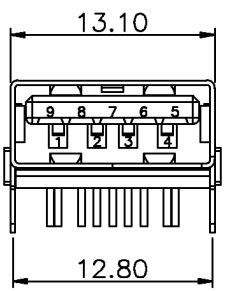
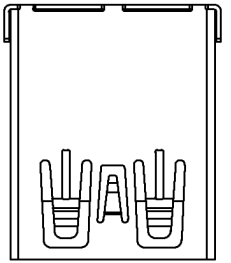

2*1.00
4*2.00
2*3.50

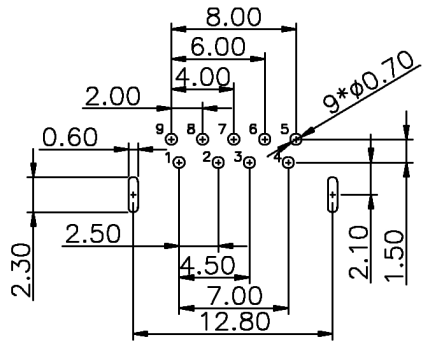

RECOMMENDER P.C.B. LAYOUT TOP VIEW
(COMPONENT SIDE TOLERANCE±0.05)

深圳市金航标电子有限公司 WWW.BDS666.COM
KH-3.0AF90ZJ-16.8 0755-83044319

UNLESS OTHERWISE, GENERAL TOLERANCE: X.xxx ±0.10 X.xx ±0.20 X.x ±0.30	NAME: 3.0 A母90° 直脚平口	P/N: 09.03.02.004
	DWG NO:	
THIRD ANGLE PROJECTION	UNIT: MM	SCALE: 1:1
ANGULAR: X.xxx° ±1° X.xx° ±3° X.x° ±5°	SIZE: A4	SHEET: 1/1
DRAWN:	CHECKED:	APPROVED:

X-ON Electronics

Largest Supplier of Electrical and Electronic Components

Click to view similar products for [USB Connectors](#) category:

Click to view products by [Kinghelm](#) manufacturer:

Other Similar products are found below :

[950](#) [A-USB A-LP-SMT-C](#) [A-USB B-TOP-C](#) [MUSBD11135](#) [17-200721](#) [217450-1](#) [KMBVX-TH-5S-B30](#) [KUSBX-AS2N-W](#) [KUSBX-SMT2AP1S-W30](#) [935](#) [957](#) [30-498-6](#) [SK-60A-2](#) [1734082-1](#) [30-470](#) [30-489](#) [30-541](#) [MAB 5 S](#) [A-USB A-2P-C](#) [MIKROE-1451](#)
[USBFTVSCCG](#) [1-1734084-2](#) [MUSBA81130](#) [NK-27-32SL](#) [NK-L8-22C-5/8](#) [10135326-001LF](#) [4198](#) [690-024-633-031](#) [UB-20PMFP-LC7001](#)
[17-200011](#) [UB-20AFMM-LL7A01](#) [CAP-WCCMLPB1](#) [CAP-WCCMLPC1](#) [2274475-3](#) [914-614A2025S10200](#) [USB3FTV7SAGF059](#)
[USB3FTV2SAZNF459](#) [USB3FTV7SAZNF459](#) [U221-041N-1WVS62-F5D](#) [HYCW153-USBD05-500B](#) [HYCW219-USBD05-075B](#)
[HYCW148-USBD05-117B](#) [HYCW149-USBD05-740B](#) [HYCW204-USBD05-108B](#) [HYCW214-USBA04-113B](#) [HYCW213-USBA04-113B](#)
[KMMX-BSMT35S-1-B30TR](#) [2345986-1](#) [10082141-N340LF](#) [10117836-011LF](#)