

Engineer Drawing

REV	ECN NO.	DESCRIPTION	DATE	APP'D
A/0		RELEASE TO PRODUCTION	01/10/18'	Scrth

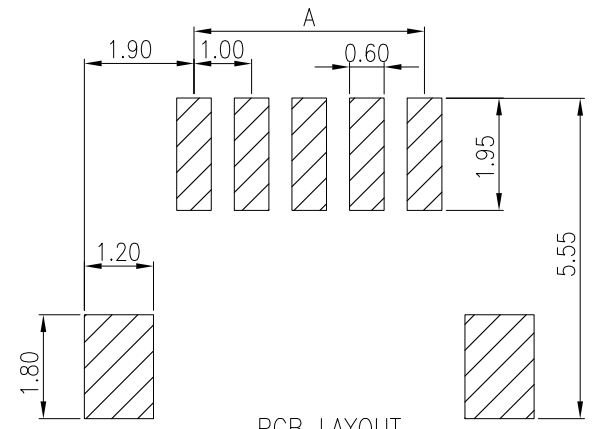
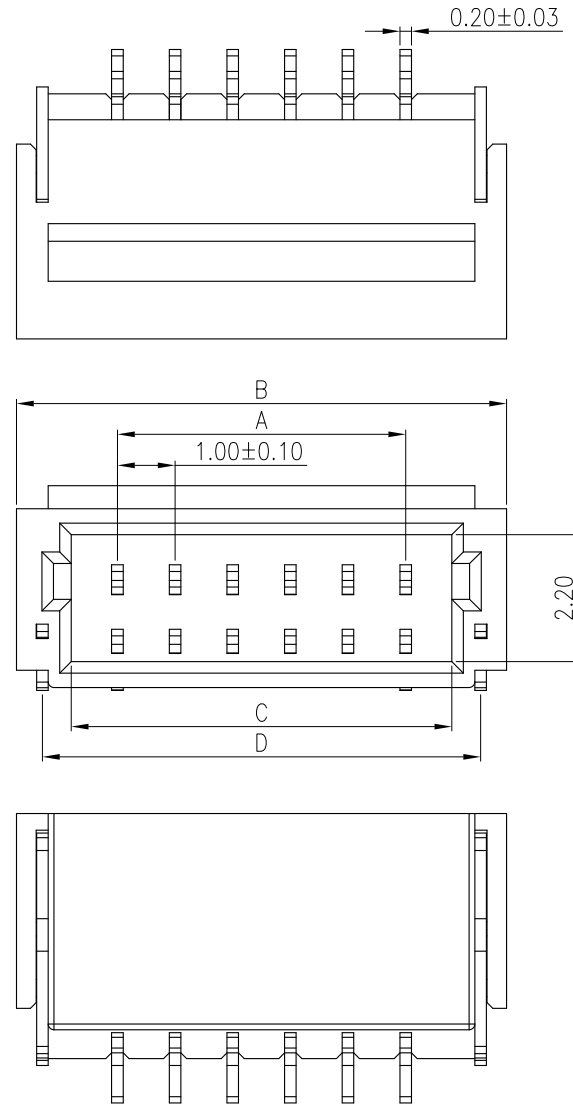

PCB LAYOUT
Tolerance: ±0.05

Poles	A	B	C	D
2	1.00	4.50	2.60	3.60
3	2.00	5.50	3.60	4.60
4	3.00	6.50	4.60	5.60
5	4.00	7.50	5.60	6.60
6	5.00	8.50	6.60	7.60
7	6.00	9.50	7.60	8.60
8	7.00	10.50	8.60	9.60
9	8.00	11.50	9.60	10.60
10	9.00	12.50	10.60	11.60
11	10.00	13.50	11.60	12.60
12	11.00	14.50	12.60	13.60
13	12.00	15.50	13.60	14.60
14	13.00	16.50	14.60	15.60
15	14.00	17.50	15.60	16.60

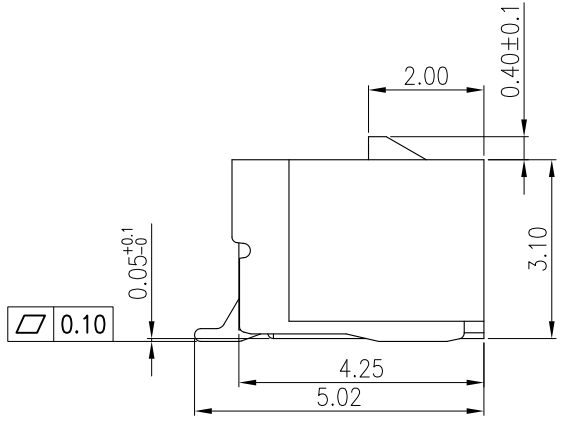

- NOTES:**
1. Material:
Insulation: LCP, UL94V-0(Nature)
Pin: Phosphor Bronze/Tin-Plated
Tab: Phosphor Bronze/Tin-Plated
 2. Current Rating: 1A AC,DC
 3. Voltage Rating: 50V AC,DC
 4. Temperature Rang: -25°C~+85°C
 5. Contact Resistance: 20mΩ Max
 6. Insulation Resistance: 100MΩ Min
 7. Withstanding Voltage: 500V AC/minute
 8. Ordering Code: A1000RSL-X

TOLERANCE X. ±0.30 X.X ±0.25 X.XX ±0.20 Angle ±3° UNLESS OTHERWISE SPECIFIED	APPROVALS		DATE	深圳市金航标电子有限公司		www.kinghelm.com.cn	
	DRAWN <i>Zhang Liao Tao</i>		01/10/18'	KH-A1000RSL-6P		0755-28190160	
	CHK'D <i>Art Phi</i>		01/10/18'	PART NO. A1000RSL-X		TITLE: WIRE TO BOARD, PLUG, PITCH 1.00mm, CRIMP TYPE, ASSEMBLY	
	APP'D <i>Art Phi</i>		01/10/18'	DRAWING NO. EN-A1000RSL-X			
	UNITS mm	SCALE 1:1	SIZE: A4	SHEET 1 OF 1	001	REV.A/0	

X-ON Electronics

Largest Supplier of Electrical and Electronic Components

Click to view similar products for [Headers & Wire Housings](#) category:

Click to view products by [Kinghelm](#) manufacturer:

Other Similar products are found below :

[57102-F02-18ULF](#) [58102-G61-06LF](#) [582553-1](#) [009176003701906](#) [01.001.5753.1](#) [0050291907](#) [02.125.8002.8](#) [609-3404](#) [61062-3](#)
[CSU011177004](#) [622-0430](#) [622-3653LF](#) [63453-116](#) [636-1030](#) [636-1427](#) [636-3427](#) [636-4007](#) [641938-9](#) [65495-038](#) [65692-001LF](#) [65781-018](#)
[65781-047](#) [65817-010LF](#) [65817-015LF](#) [66207-023LF](#) [67095-007LF](#) [67601157](#) [68631-112](#) [68645-018](#) [699319-000](#) [M90C108951C](#)
[70.362.1628.0](#) [70-4210](#) [70-4226B](#) [70-4853B](#) [707-5028](#) [71.350.2428.0](#) [71961-016LF](#) [733-134](#) [733-162](#) [754199-000](#) [760-3052](#) [80.063.4001.1](#)
[800-90-001-10-001000](#) [800-90-010-10-002000](#) [801-43-002-10-013000](#) [801-43-006-10-002000](#) [803-41-018-10-001000](#) [803-43-024-10-](#)
[001000](#) [803-93-012-10-001000](#)