

PCB LAYOUT

SPECIFICATIONS

- 1、Current Rating: 3A AC, DC
- 2、Voltage Rating: 250V AC, DC
- 3、Temperatuer Range: -25°C~+85°C
- 4、Contact Resistance: 20mΩ Max
- 5、Insulation Resistance: 1000MΩ Min
- 6、Withstanding Voltang: 800V AC/minute
- 7、Material: Wafer LCP, UL94V-0
PIN Brass Tin-plated

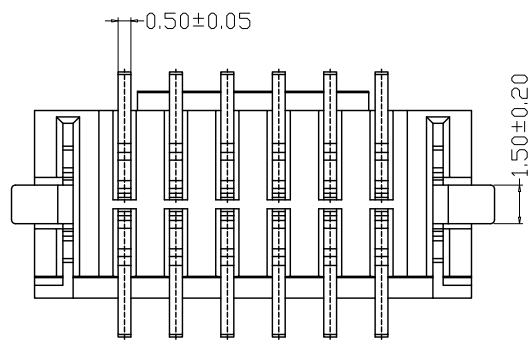
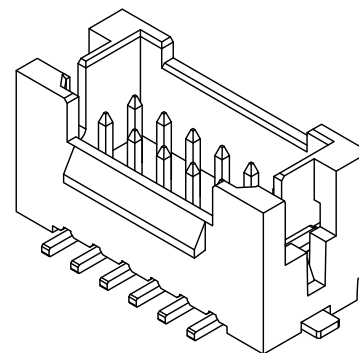
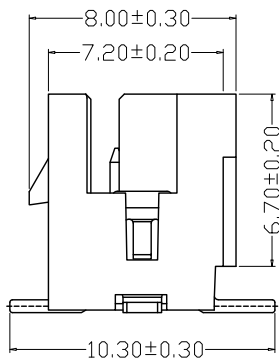
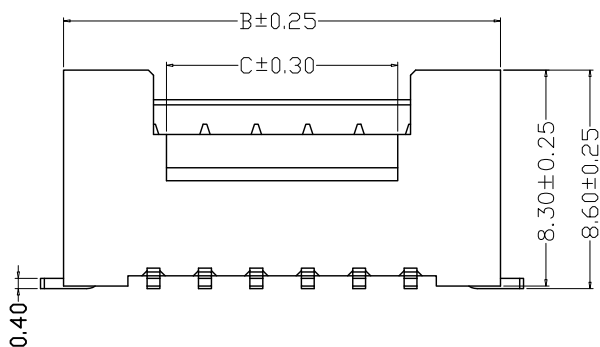

编号	尺寸 (mm)		
	A	B	C
A2009-2x02AB	2.00	9.00	3.00
A2009-2x03AB	4.00	11.00	3.00
A2009-2x04AB	6.00	13.00	3.00
A2009-2x05AB	8.00	15.00	5.00
A2009-2x06AB	10.00	17.00	7.00
A2009-2x07AB	12.00	19.00	9.00
A2009-2x08AB	14.00	21.00	11.00
A2009-2x09AB	16.00	23.00	13.00
A2009-2x10AB	18.00	25.00	15.00
A2009-2x11AB	20.00	27.00	17.00
A2009-2x12AB	22.00	29.00	19.00
A2009-2x13AB	24.00	31.00	21.00
A2009-2x14AB	26.00	33.00	23.00
A2009-2x18AB	34.00	41.00	31.00
A2009-2x20AB	38.00	45.00	35.00

制图 DRAWN	变更内容 DESCRIPTION	日期 DATE	GENERAL TOLERANCE		制图 DRAWING	钱岳生 2022、05、15		料号 PART NO.	A2009-2*nAB		版本 REV.	A
			X.±0.25	X.*±2'	审核 CHECK	潘云丹 2022、05、16		品名 TITLE	PHB双头带焊片立贴 WAFER SMT TYPE		页次 SHEET	1/1
			.X±0.20	.X*±1'	核准 APPROVAL	张名 2022、05、16		客户料号 CUTM. NO.				
			.XX±0.15	.XX*±0.5'	单位 UNITS	MM	比例 SCALE	1:1	深圳市金航标电子有限公司 www.kinghel.com.cn		KH-A2009-2X18AB 0755-28190160	
			.XXX±0.10	.XXX*±0.5'								

X-ON Electronics

Largest Supplier of Electrical and Electronic Components

Click to view similar products for [Headers & Wire Housings](#) category:

Click to view products by [Kinghelm](#) manufacturer:

Other Similar products are found below :

[57102-F02-18ULF](#) [58102-G61-06LF](#) [582553-1](#) [009176003701906](#) [01.001.5753.1](#) [0050291907](#) [02.125.8002.8](#) [609-3404](#) [61062-3](#)
[CSU011177004](#) [622-0430](#) [622-3653LF](#) [63453-116](#) [636-1030](#) [636-1427](#) [636-3427](#) [636-4007](#) [641938-9](#) [644827-2](#) [65495-038](#) [65692-001LF](#)
[65781-018](#) [65781-047](#) [65817-010LF](#) [65817-015LF](#) [66207-023LF](#) [67095-007LF](#) [67601157](#) [68631-112](#) [68645-018](#) [699319-000](#)
[M90C108951C](#) [70.362.1628.0](#) [70-4210](#) [70-4226B](#) [70-4853B](#) [707-5028](#) [71.350.2428.0](#) [71961-016LF](#) [733-134](#) [733-162](#) [754199-000](#) [760-](#)
[3052](#) [80.063.4001.1](#) [800-90-001-10-001000](#) [800-90-010-10-002000](#) [801-43-002-10-013000](#) [801-43-006-10-002000](#) [803-41-018-10-001000](#)
[803-43-024-10-001000](#)