

版本 REV.	日期 DATE	ECN NO.	变更内容 DESCRIPTION	制图 DRAWN

SPECIFICATIONS

- 1、Current Rating: 3A AC, DC
- 2、Voltage Rating: 250V AC, DC
- 3、Temperatuer Range: -25°C~+85°C
- 4、Contact Resistance: 30mΩ Max
- 5、Insulation Resistance: 1000MΩ Min
- 6、Withstanding Voltang: 800V AC/minute
- 7、Material: Wafer PA66, Beige UL94V-0
PIN Brass Tin-plated

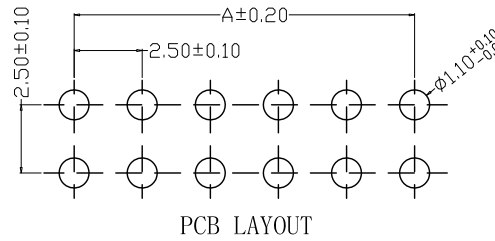
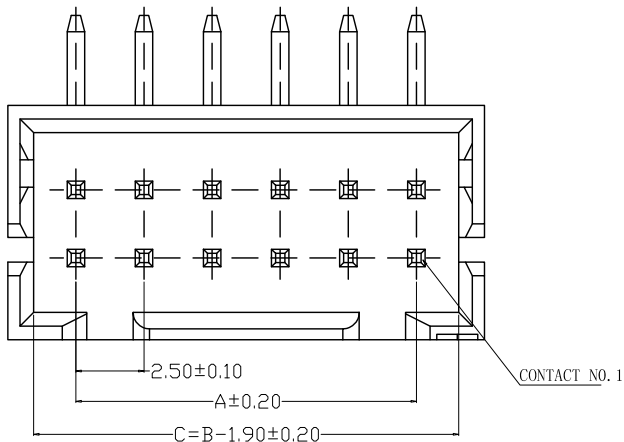
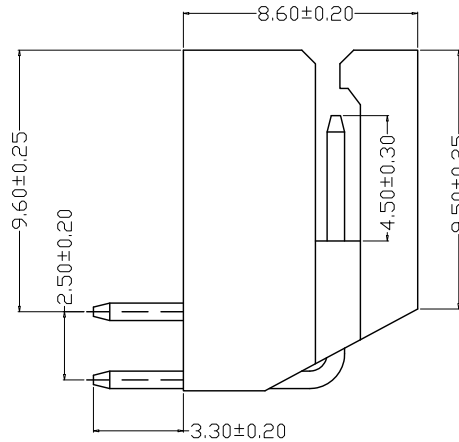
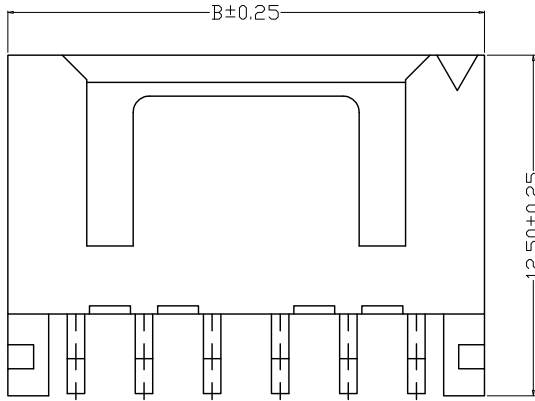
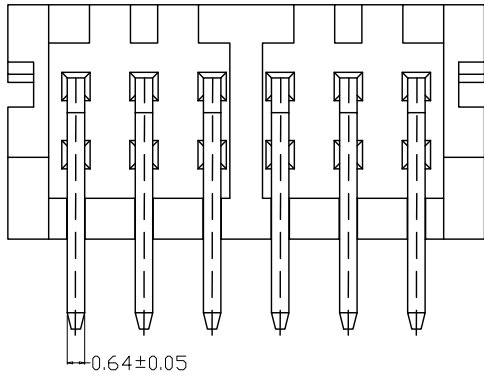
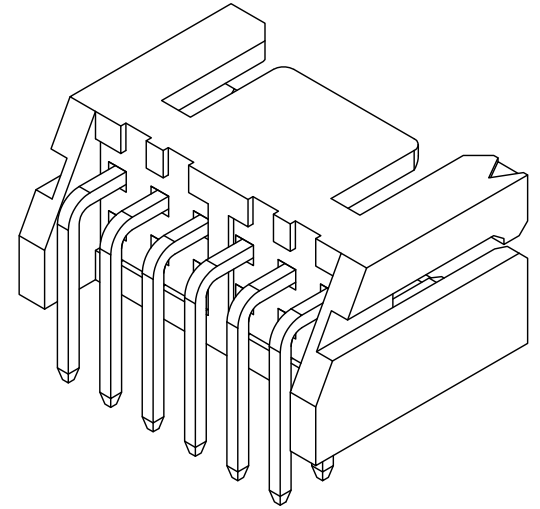

编 号	尺寸 (mm)	
	A	B
A2557-2*02AW	2.50	7.50
A2557-2*03AW	5.00	10.00
A2557-2*04AW	7.50	12.50
A2557-2*05AW	10.00	15.00
A2557-2*06AW	12.50	17.50
A2557-2*07AW	15.00	20.00
A2557-2*08AW	17.50	22.50
A2557-2*09AW	20.00	25.00
A2557-2*10AW	22.50	27.50
A2557-2*11AW	25.00	30.00
A2557-2*12AW	27.50	32.50
A2557-2*20AW	47.50	52.50

GENERAL TOLERANCE		制图	钱岳生		料号	A2557-2*02nAW		版本	A
X.X±0.25	X.*±2'	DRAWING	2021、05、03		PART NO.	XH2.5弯针		页次	1/1
X.XX±0.20		审核	张名		TITLE	WAFER DIP TYPE		SHEET	
X.XXX±0.10		CHECK	2021、05、04		客户料号				
		核准	张名		CUTM. NO.				
		APPROVAL	2021、05、05		深圳市金航标电子有限公司		www.kinghel.com.cn		
		单位	MM	比例	1:1	KH-A2557-2X04AW		0755-28190160	
		UNITS		SCALE					

X-ON Electronics

Largest Supplier of Electrical and Electronic Components

Click to view similar products for [Headers & Wire Housings](#) category:

Click to view products by [Kinghelm](#) manufacturer:

Other Similar products are found below :

[57102-F02-18ULF](#) [58102-G61-06LF](#) [582553-1](#) [009176003701906](#) [01.001.5753.1](#) [0050291907](#) [02.125.8002.8](#) [609-3404](#) [61062-3](#)
[CSU011177004](#) [622-0430](#) [622-3653LF](#) [63453-116](#) [636-1030](#) [636-1427](#) [636-3427](#) [636-4007](#) [641938-9](#) [644827-2](#) [65495-038](#) [65692-001LF](#)
[65781-018](#) [65781-047](#) [65817-010LF](#) [65817-015LF](#) [66207-023LF](#) [67095-007LF](#) [67601157](#) [68631-112](#) [68645-018](#) [699319-000](#)
[M90C108951C](#) [70.362.1628.0](#) [70-4210](#) [70-4226B](#) [70-4853B](#) [707-5028](#) [71.350.2428.0](#) [71961-016LF](#) [733-134](#) [733-162](#) [754199-000](#) [760-](#)
[3052](#) [80.063.4001.1](#) [800-90-001-10-001000](#) [800-90-010-10-002000](#) [801-43-002-10-013000](#) [801-43-006-10-002000](#) [803-41-018-10-001000](#)
[803-43-024-10-001000](#)