

A B C D E F

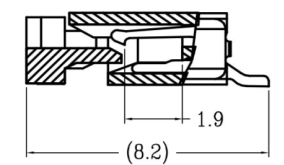

SECTION A-A

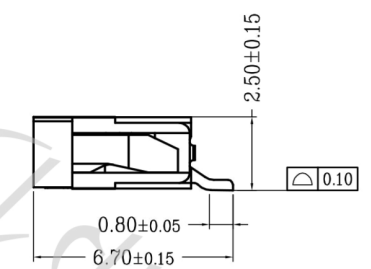
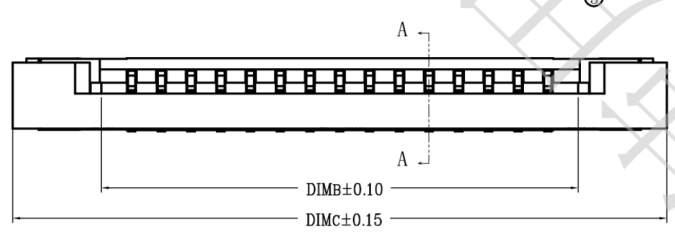
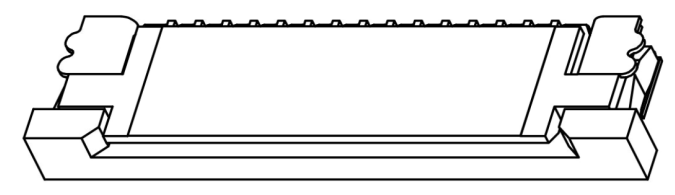
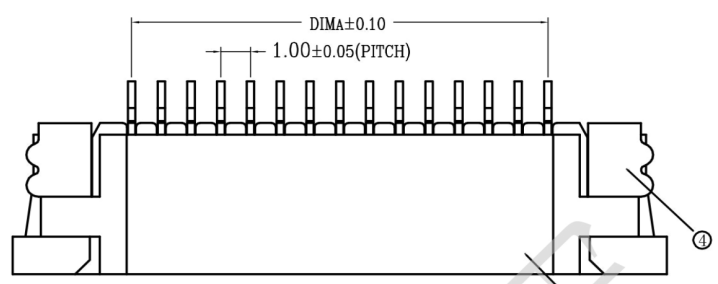
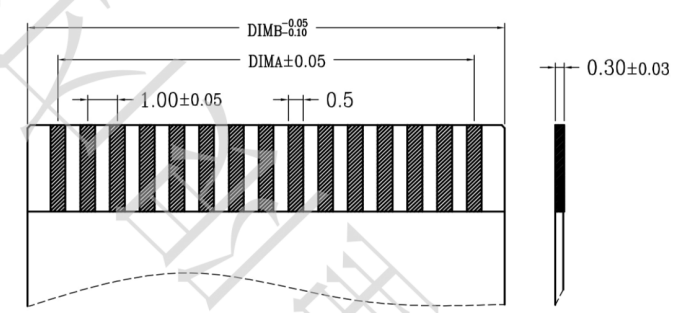
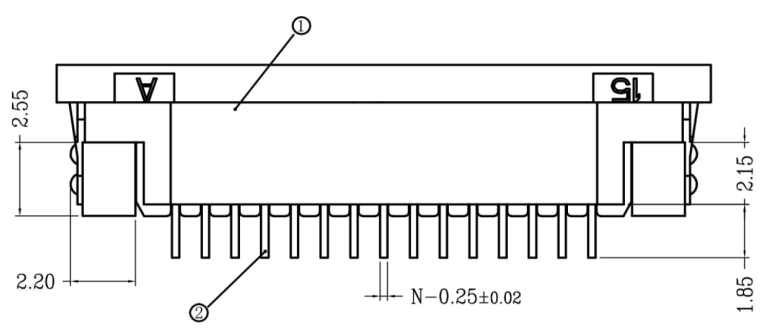

适用扁平线

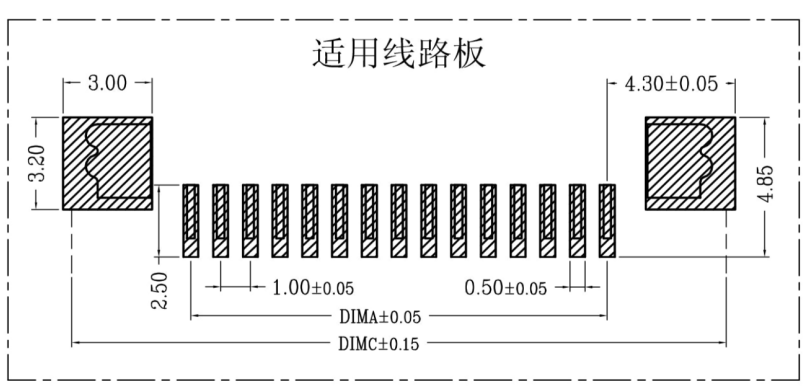

适用线路板

| 序号 | 品名 | 材质 |
|----|------------------|----------------|
| ① | 1.0K型胶芯 (H2.5) | LCP UL94V-0 本色 |
| ② | 1.0K型上接端子 (H2.5) | 磷青铜/表面镀锡 |
| ③ | 1.0K型后盖 (H2.5) | LCP UL94V-0 黑色 |
| ④ | 1.0K型卧式焊片 (H2.5) | 黄铜/表面镀锡 |

| CKT | DIM A | DIM B | DIM C |
|-----|-------|-------|-------|
| 4 | 3.00 | 5.03 | 11.00 |
| 5 | 4.00 | 6.03 | 12.00 |
| 6 | 5.00 | 7.03 | 13.00 |
| 7 | 6.00 | 8.03 | 14.00 |
| 8 | 7.00 | 9.03 | 15.00 |
| 9 | 8.00 | 10.03 | 16.00 |
| 10 | 9.00 | 11.03 | 17.00 |
| 11 | 10.00 | 12.03 | 18.00 |
| 12 | 11.00 | 13.03 | 19.00 |
| 13 | 12.00 | 14.03 | 20.00 |
| 14 | 13.00 | 15.03 | 21.00 |
| 15 | 14.00 | 16.03 | 22.00 |
| 16 | 15.00 | 17.03 | 23.00 |
| 17 | 16.00 | 18.03 | 24.00 |
| 18 | 17.00 | 19.03 | 25.00 |
| 19 | 18.00 | 20.03 | 26.00 |
| 20 | 19.00 | 21.03 | 27.00 |
| 21 | 20.00 | 22.03 | 28.00 |
| 22 | 21.00 | 23.03 | 29.00 |
| 23 | 22.00 | 24.03 | 30.00 |
| 24 | 23.00 | 25.03 | 31.00 |
| 25 | 24.00 | 26.03 | 32.00 |
| 26 | 25.00 | 27.03 | 33.00 |
| 27 | 26.00 | 28.03 | 34.00 |
| 28 | 27.00 | 29.03 | 35.00 |
| 29 | 28.00 | 30.03 | 36.00 |
| 30 | 29.00 | 31.03 | 37.00 |
| 31 | 30.00 | 32.03 | 38.00 |
| 32 | 31.00 | 33.03 | 39.00 |
| 33 | 32.00 | 34.03 | 40.00 |
| 34 | 33.00 | 35.03 | 41.00 |
| 35 | 34.00 | 36.03 | 42.00 |
| 36 | 35.00 | 37.03 | 43.00 |
| 37 | 36.00 | 38.03 | 44.00 |
| 38 | 37.00 | 39.03 | 45.00 |
| 39 | 38.00 | 40.03 | 46.00 |
| 40 | 39.00 | 41.03 | 47.00 |

技术指标:

1. 塑件表面应光洁、无毛边、无明显收缩、缺陷、裂纹等现象。
2. 温度范围: -25° C~85° C.
3. 额定电压: 50V, AC/DC(等效).
4. 接触电阻: ≤0.03Ω.
5. 绝缘电阻: ≥500MΩ

一般公差 (TOLERANCE)
 X ±0.50 XX ±1.0
 Y ±0.20 ZXX ±0.05
 ANGLES ±1°

深圳市金航标电子有限公司 www.kinghelm.com.cn
 KH-CL1.0-H2.5-14PS-SMT 0755-28190160

| | |
|--|----------------------|
| 品名 (TITLE) 1.0 Pitch K型卧式上接 (H=2.5) | 制图 (DR) 王涛 |
| 料号 (DWG.NO) | 校对 (CHKD) 吴鹏 |
| 比例 (SCALE) 1:1 | 审核 (APPD) 黄志明 |
| 单位 (UNITS) mm | 张数 (SHEET) 1 OF 1 |
| 尺寸 (SIZE) A4 | REV 1 |

A B C D E F

X-ON Electronics

Largest Supplier of Electrical and Electronic Components

Click to view similar products for [FFC & FPC Connectors](#) category:

Click to view products by [Kinghelm](#) manufacturer:

Other Similar products are found below :

[00-6200-227-022-800](#) [006205250500825+](#) [006205280500825+](#) [FPH-1602G](#) [086222026001800](#) [52610-0675](#) [62674-201121DLF](#) [52746-1671-TR250](#) [10051922-1610EHLF](#) [10051922-2810EHLF](#) [686322124422](#) [XF3M-2915-1B-R100](#) [AYF353125A](#) [AYF530665TA](#) [AYF534065TA](#) [20FLH-RSM1-TB](#) [PCA-7F-25-HL-3-G](#) [207356-1](#) [52807-0430](#) [FFC05011-10SBB114W5M](#) [502250-8027](#) [FH28K-40S-0.5SH](#) [200528-0260](#) [FH28K-10S-0.5SH](#) [501951-1250](#) [X05B20U43T](#) [0.5K-DX-30PWB](#) [DS1020-08-10VBT12](#) [THD0515-34CL-GF](#) [X05A10L28G](#) [ECC2841061EU](#) [20539-030E-01](#) [1.0K-DHQX-16PWB](#) [1.0K-DHQX-30PWB](#) [1775333-6](#) [10054365-202110ELF](#) [10054365-242110ELF](#) [10054365-282110ELF](#) [10064555-392220HLF](#) [59453-041110EBHLF](#) [59453-091110EDHLF](#) [62674-241141ALF](#) [62684-432100ALF](#) [62684-451100AHLF](#) [62684-5721N0ALF](#) [HFW11R-1STE1MTLF](#) [HFW12R-1STE9LF](#) [HFW14R-1STE9MTLF](#) [HFW18S-2STE9LF](#) [HFW20R-1STAE1HLF](#)