

A B C D E F

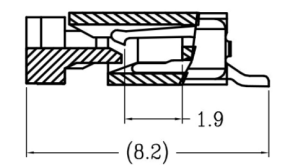

SECTION A-A

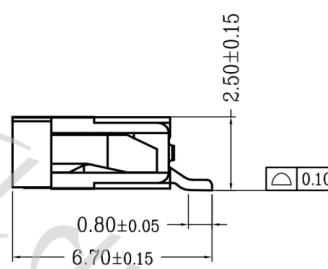
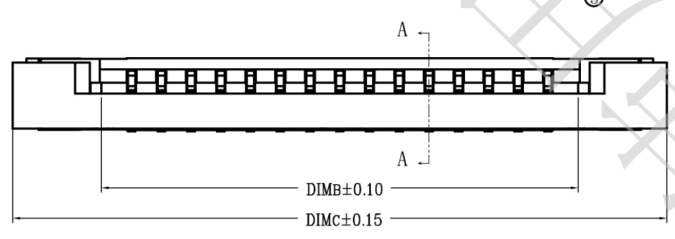
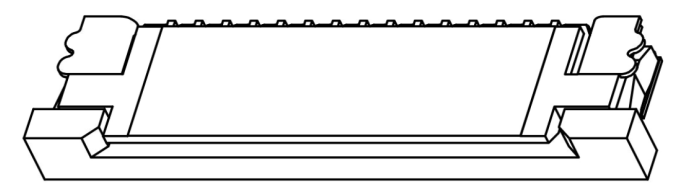
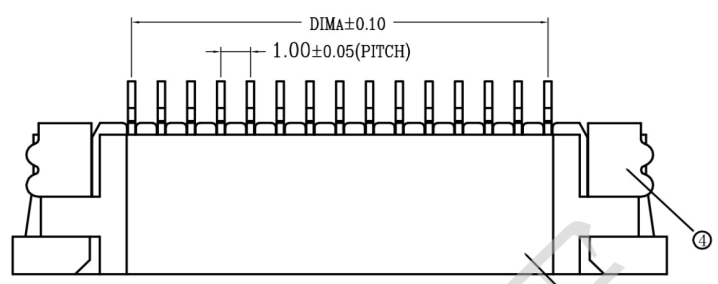
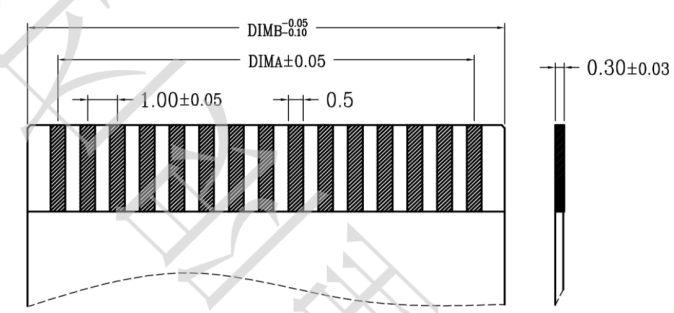
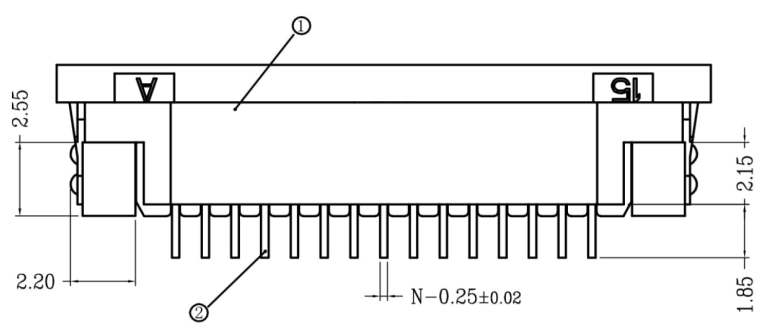

适用扁平线

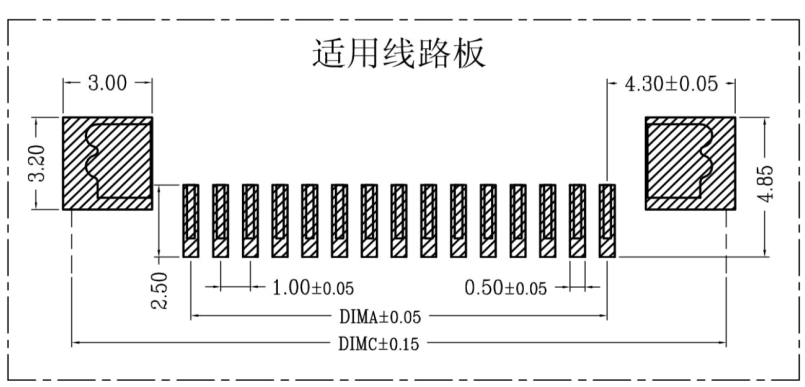

适用线路板

序号	品名	材质
①	1.0K型胶芯 (H2.5)	LCP UL94V-0 本色
②	1.0K型上接端子 (H2.5)	磷青铜/表面镀锡
③	1.0K型后盖 (H2.5)	LCP UL94V-0 黑色
④	1.0K型卧式焊片 (H2.5)	黄铜/表面镀锡

CKT	DIM A	DIM B	DIM C
4	3.00	5.03	11.00
5	4.00	6.03	12.00
6	5.00	7.03	13.00
7	6.00	8.03	14.00
8	7.00	9.03	15.00
9	8.00	10.03	16.00
10	9.00	11.03	17.00
11	10.00	12.03	18.00
12	11.00	13.03	19.00
13	12.00	14.03	20.00
14	13.00	15.03	21.00
15	14.00	16.03	22.00
16	15.00	17.03	23.00
17	16.00	18.03	24.00
18	17.00	19.03	25.00
19	18.00	20.03	26.00
20	19.00	21.03	27.00
21	20.00	22.03	28.00
22	21.00	23.03	29.00
23	22.00	24.03	30.00
24	23.00	25.03	31.00
25	24.00	26.03	32.00
26	25.00	27.03	33.00
27	26.00	28.03	34.00
28	27.00	29.03	35.00
29	28.00	30.03	36.00
30	29.00	31.03	37.00
31	30.00	32.03	38.00
32	31.00	33.03	39.00
33	32.00	34.03	40.00
34	33.00	35.03	41.00
35	34.00	36.03	42.00
36	35.00	37.03	43.00
37	36.00	38.03	44.00
38	37.00	39.03	45.00
39	38.00	40.03	46.00
40	39.00	41.03	47.00

技术指标:

- 塑件表面应光洁、无毛边、无明显收缩、缺陷、裂纹等现象。
- 温度范围: -25° C~85° C.
- 额定电压: 50V, AC/DC(等效).
- 接触电阻: ≤0.03Ω.
- 绝缘电阻: ≥500MΩ

一般公差 (TOLERANCE)
 X ±0.50 XX ±1.0
 Y ±0.20 ZXX ±0.05
 ANGLES ±1°

深圳市金航标电子有限公司 www.kinghelm.com.cn
 KH-CL1.0-H2.5-34PS-SMT 0755-28190160

品名 (TITLE) 1.0 Pitch K型卧式上接 (H=2.5)	制图 (DR) 王涛
料号 (DWG.NO)	校对 (CHKD) 吴鹏
比例 (SCALE) 1:1	审核 (APPD) 黄志明
单位 (UNITS) mm	张数 (SHEET) 1 OF 1
尺寸 (SIZE) A4	版数 (REV) 1

X-ON Electronics

Largest Supplier of Electrical and Electronic Components

Click to view similar products for [FFC & FPC Connectors](#) category:

Click to view products by [Kinghelm](#) manufacturer:

Other Similar products are found below :

[00-6200-227-022-800](#) [006205250500825+](#) [006205280500825+](#) [FPH-1602G](#) [086222026001800](#) [52610-0675](#) [62674-201121DLF](#) [52746-1671-TR250](#) [10051922-1610EHLF](#) [10051922-2810EHLF](#) [686322124422](#) [XF3M-2915-1B-R100](#) [AYF353125A](#) [AYF530665TA](#) [AYF534065TA](#) [20FLH-RSM1-TB](#) [PCA-7F-25-HL-3-G](#) [207356-1](#) [52807-0430](#) [FFC05011-10SBB114W5M](#) [502250-8027](#) [FH28K-40S-0.5SH](#) [200528-0260](#) [FH28K-10S-0.5SH](#) [501951-1250](#) [X05B20U43T](#) [0.5K-DX-30PWB](#) [DS1020-08-10VBT12](#) [THD0515-34CL-GF](#) [X05A10L28G](#) [ECC2841061EU](#) [20539-030E-01](#) [1.0K-DHQX-16PWB](#) [1.0K-DHQX-30PWB](#) [1775333-6](#) [10054365-202110ELF](#) [10054365-242110ELF](#) [10054365-282110ELF](#) [10064555-392220HLF](#) [59453-041110EBHLF](#) [59453-091110EDHLF](#) [62674-241141ALF](#) [62684-432100ALF](#) [62684-451100AHLF](#) [62684-5721N0ALF](#) [HFW11R-1STE1MTLF](#) [HFW12R-1STE9LF](#) [HFW14R-1STE9MTLF](#) [HFW18S-2STE9LF](#) [HFW20R-1STAE1HLF](#)