

MARK	DATE	DESCRIPTION	DESIGN
A	2020.05.06	PROPOSAL	CHEN

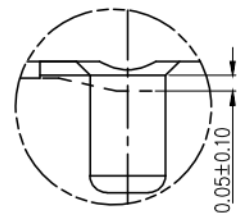

放大图: A  
比例: 8:1

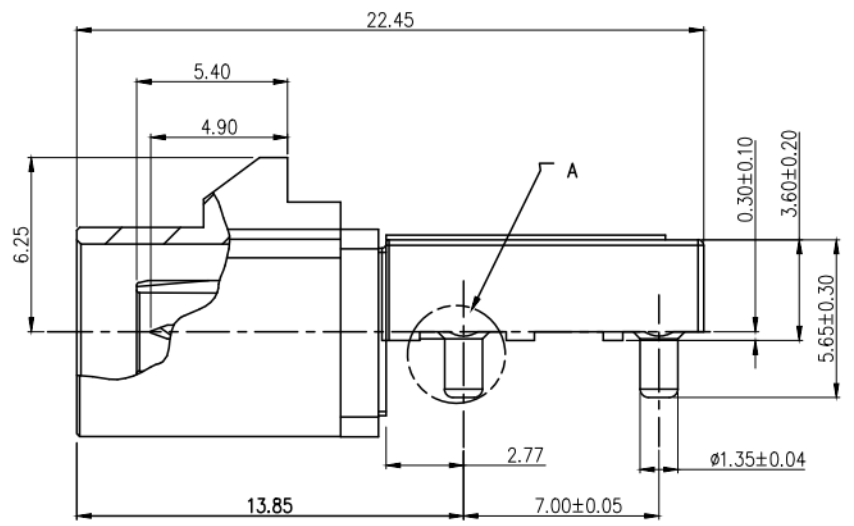
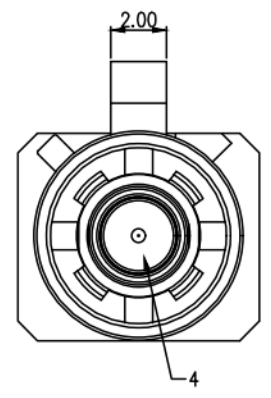
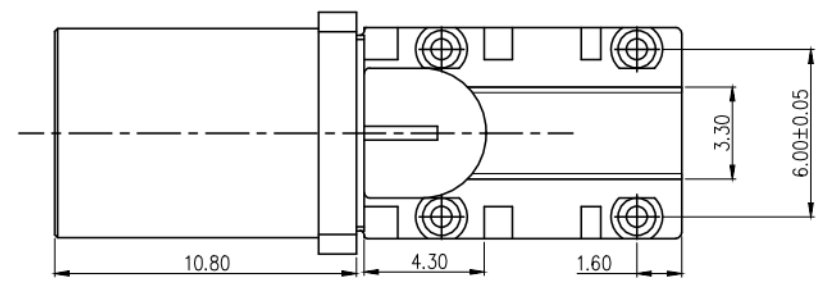
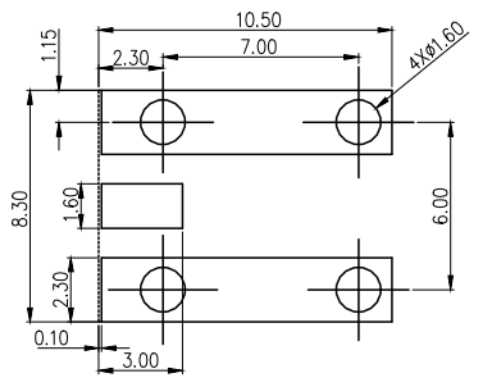

1. PART NO. LEGEND: PCB ALL TOLERANCE  $\pm 0.05$   
7.03A0 .000 8 9 X  
TYPE  
CONTACT AREA PLATING SPEC: GOLD PLATING: 8=30u"  
SOLDER AREA PLATING SPEC: Tin PLATING: 8=80u"
2. PERFORMANCE:  
2.1: CONTACT RESISTANCE: INITIAL VALUE 50mOHM Max,  
2.2: FREQUENCY RANGE: DC to 6GHz  
2.3 VSWR: 0-6GHz 1.60Max  
2.4 VOLTAGE RATING: 50V (AC/DC).  
2.5: CURRENT RATING: 1A/PIN.  
2.6: INSULATION RESISTANCE: 100MOHM Min.  
2.7: MATING CYCLES: 25 TIMES Min.  
2.8: OPERATING TEMPERATURE: -40°C~+105°C

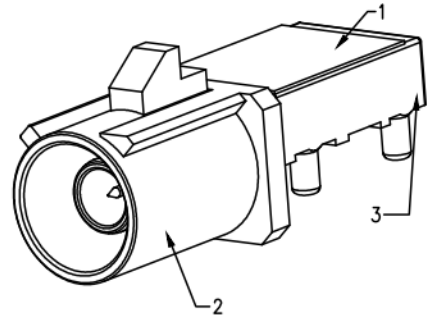

4	MOLDING	THERMOPLASTIC+BRASS	BLACK+PLATING GOLD	1
3	BODY	ZINC ALLOY	PLATING Sn	1
2	HOUSING	THERMOPLASTIC UL94V-0	ACCORDANCE WITH THE REQUIREMENTS	1
1	MAYLAR	KAPTON		1
NO.	COMPONENTS	MATERIALS	FINISH/COLOR SPECIFICATION	QUANTITY

深圳市金航标电子有限公司 [www.kinghelm.com.cn](http://www.kinghelm.com.cn)

KH-FAKRA-D-CB 0755-28190160

DRAWING NO	PART NAME:	FAKRA LOW PROFILE CONNECTOR CUSTOMER DRAWING			
7.03A0-C	PART NO.	7.03A0.00089X			
APPROVED	VERIFIED	DESIGN	DATE	UNITS	SCALE
		CHEN	2020.05.06	mm	4:1
				PAGE	REV
				1/2	A

UNLESS OTHERWISE SPECIFIED TOLERANCE			
ANG	TOL	DIM	TOL
.X	$\pm 3.0^\circ$	.X	$\pm 0.30$
.XX	$\pm 2.0^\circ$	.XX	$\pm 0.20$
.XXX	$\pm 1.0^\circ$	.XXX	$\pm 0.10$

NOTE: ALL RIGHTS RESERVED, BANNED COPY!

1 2 3 4 5 6 7 8 9 10 11 12

DRAWING TYPE CUSTOMER DRAWING

MARK	DATE	DESCRIPTION	DESIGN
A	2020.05.06	PROPOSAL	CHEN

KH-FAKRA-A-CB	KH-FAKRA-B-CB	KH-FAKRA-C-CB	KH-FAKRA-D-CB	KH-FAKRA-E-CB	KH-FAKRA-F-CB	KH-FAKRA-G-CB	KH-FAKRA-H-CB	KH-FAKRA-I-CB	KH-FAKRA-K-CB
KH-FAKRA-L-CB	KH-FAKRA-M-CB	KH-FAKRA-N-CB	KH-FAKRA-Z-CB						

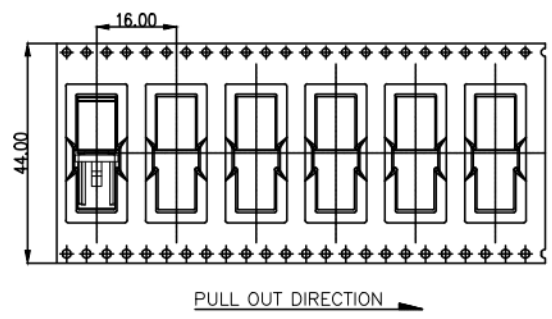

NOTE:  
1.PER REEL: 400PCS

NOTE: ALL RIGHTS RESERVED,BANNED COPY!

UNLESS OTHERWISE SPECIFIED TOLERANCE			
ANG	TOL	DIM	TOL
.X	±3.0°	.X	±0.30
.XX	±2.0°	.XX	±0.20
.XXX	±1.0°	.XXX	±0.10

深圳市金航标电子有限公司		www.kinghelm.com.cn			
KH-FAKRA-D-CB		0755-28190160			
		DRAWING NO		PART NAME:	
		7.03A0-C		FAKRA LOW PROFILE CONNECTOR CUSTOMER DRAWING	
		DESIGN		PART NO.	
		CHEN		7.03A0.00089X	
APPROVED	VERIFIED	DATE	UNITS	SCALE	PAGE
		2020.05.06	mm	4:1	2/2
					REV
					A

1 2 3 4 5 6 7 8 9 10 11 12 QP-04-33-B

DRAWING TYPE PACKAGE DRAWING

MARK	DATE	DESCRIPTION	DESIGN
A	2020.05.06	PROPOSAL	CHEN

NOTES:

- MATERIAL:
  - CARRY TAPE:HIPS,T=0.50±0.05mm,BLACK
  - REEL:HIPS,
  - SHIM:PE,CLEAR.
- PRIMARY PACKING:400PCS/REEL.
- SECONDARY PACKING:SEE PACKING LIST
- PEELING RESISTANCE: 0.2~1.2N(20~120gf); PEELING ANGLE: 165°~180°; PEELING SPEED: 300mm/minutes.

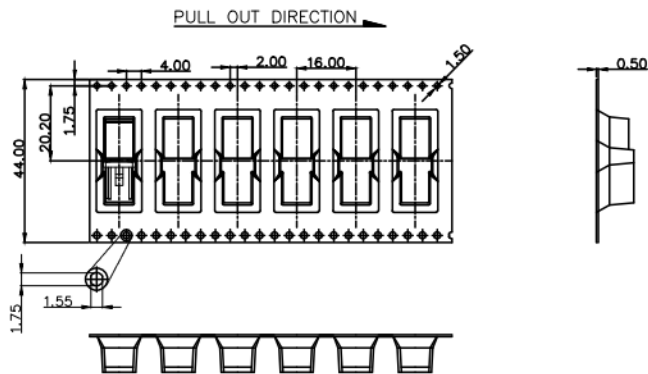

PER REEL with PE Bag

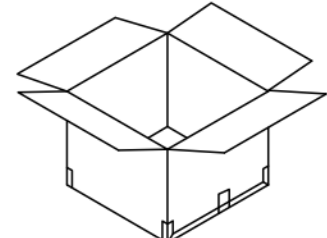
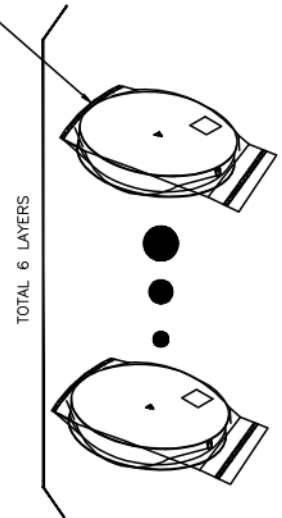

6 REEL PER CARTON  
Total 2400 PCS

TRANSPARENT GULE TAPE

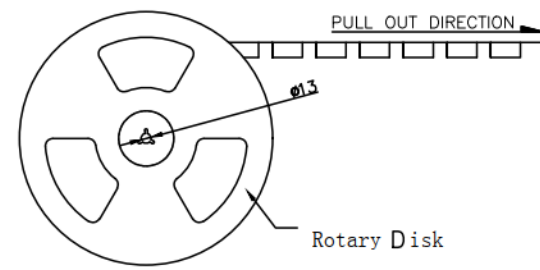
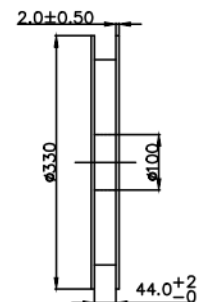
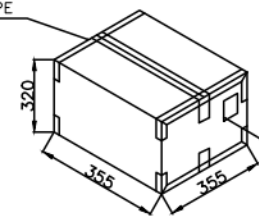

Rotary Disk

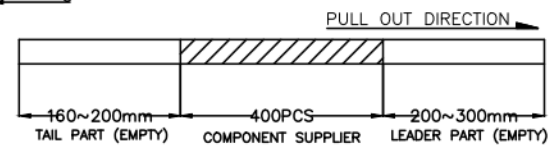

深圳市金航标电子有限公司		www.kinghelm.com.cn			
KH-FAKRA-D-CB		0755-28190160			
UNLESS OTHERWISE SPECIFIED TOLERANCE	DRAWING NO 7.03A0-P	PART NAME:		FAKRA LOW PROFILE CONNECTOR PACKING DRAWING	
		PART NO.		7.03A0.00089X	
ANG	TOL	DIM	TOL	DATE	UNITS
.X	±3.0°	.X	±0.20	2020.05.06	mm
.XX	±2.0°	.XX	±0.10	SCALE	PAGE
.XXX	±1.0°	.XXX	±0.05	1:1	1/1
APPROVED	VERIFIED	DESIGN	CHEN	REV	A

NOTE: ALL RIGHTS RESERVED,BANNED COPY!

## X-ON Electronics

Largest Supplier of Electrical and Electronic Components

*Click to view similar products for [RF Connectors / Coaxial Connectors](#) category:*

*Click to view products by [Kinghelm](#) manufacturer:*

Other Similar products are found below :

[8915-1511-000](#) [89674-0827](#) [6002-7051-003](#) [6059674-1](#) [630059-000](#) [M39030/3-01N](#) [6501-1071-002](#) [6769](#) [7002-1572-002](#) [7003-1542-011](#)  
[7003-1572-002](#) [7004-1512-000](#) [7009-1511-004](#) [7101-1541-010](#) [7105-1521-002](#) [7145-1521-002](#) [7203-1571-003](#) [7209-1511-011](#) [7210-1511-](#)  
[040](#) [7242-1511-000](#) [73216-2241](#) [73404-2300](#) [7405-1521-005](#) [7405-1521-802](#) [8527](#) [8547](#) [FS11V](#) [8808-1511-001](#) [9074-9513-000](#) [PL11C-](#)  
[026](#) [PL71-9](#) [PL74C-221](#) [9408-1113-000](#) [980-8666-005](#) [1200690078](#) [1-201144-1](#) [120919](#) [R107003010W](#) [R112186000](#) [R113053000W](#)  
[R113082097](#) [R113236000](#) [R113240000](#) [R113240097](#) [R114083000](#) [R114670000W](#) [R123415000W](#) [R124072220W](#) [R124076320](#)  
[R124076450](#)