

MARK	DATE	DESCRIPTION	DESIGN
A	2020.05.06	PROPOSAL	CHEN

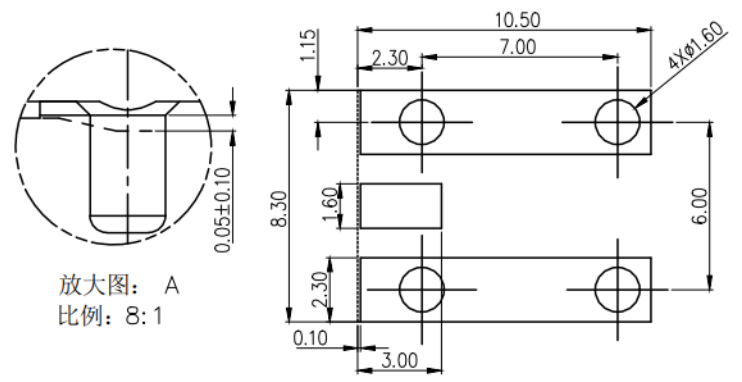

放大图: A
比例: 8:1

- PART NO. LEGEND: PCB ALL TOLERANCE ± 0.05
7.03A0 .000 8 9 X
TYPE
CONTACT AREA PLATING SPEC: GOLD PLATING: 8=30u"
SOLDER AREA PLATING SPEC: Tin PLATING: 8=80u"
- PERFORMANCE:
 - CONTACT RESISTANCE: INITIAL VALUE 50mOHM Max,
 - FREQUENCY RANGE: DC to 6GHz
 - VSWR: 0-6GHz 1.60Max
 - VOLTAGE RATING: 50V (AC/DC).
 - CURRENT RATING: 1A/PIN.
 - INSULATION RESISTANCE: 100MOHM Min.
 - MATING CYCLES: 25 TIMES Min.
 - OPERATING TEMPERATURE: $-40^{\circ}\text{C} \sim +105^{\circ}\text{C}$

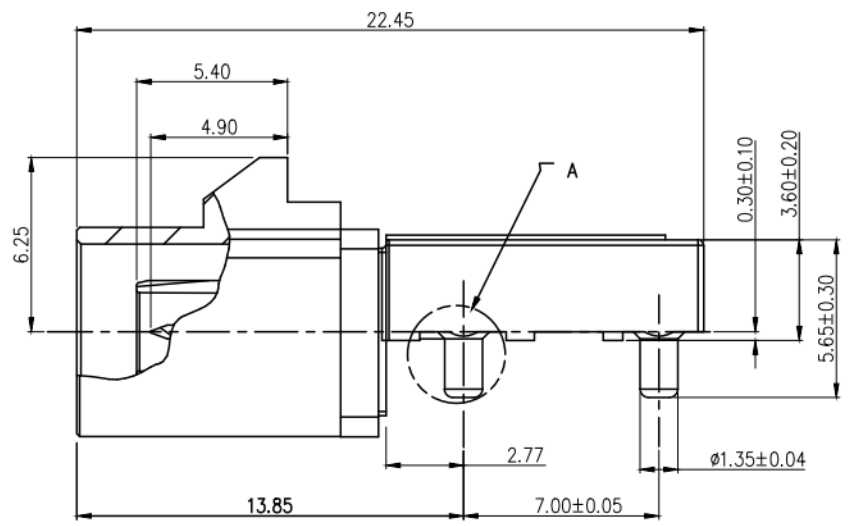
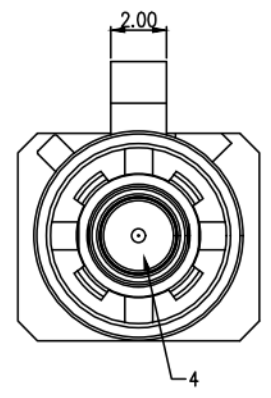
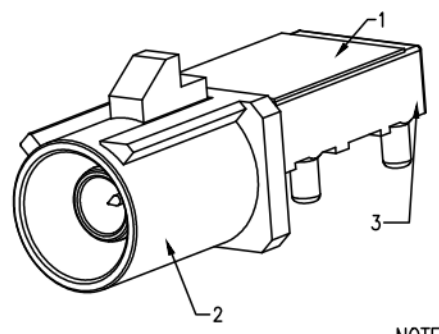
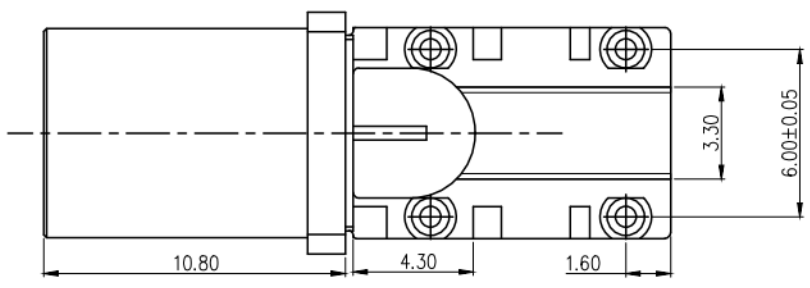

4	MOLDING	THERMOPLASTIC+BRASS	BLACK+PLATING GOLD	1
3	BODY	ZINC ALLOY	PLATING Sn	1
2	HOUSING	THERMOPLASTIC UL94V-0	ACCORDANCE WITH THE REQUIREMENTS	1
1	MAYLAR	KAPTON		1
NO.	COMPONENTS	MATERIALS	FINISH/COLOR SPECIFICATION	QUANTITY

深圳市金航标电子有限公司 www.kinghelm.com.cn

KH-FAKRA-H-CB 0755-28190160

DRAWING NO	PART NAME:	FAKRA LOW PROFILE CONNECTOR CUSTOMER DRAWING			
7.03A0-C	PART NO.	7.03A0.00089X			
APPROVED	DESIGN	DATE	UNITS	SCALE	PAGE
	CHEN	2020.05.06	mm	4:1	1/2
VERIFIED					REV
					A

UNLESS OTHERWISE SPECIFIED TOLERANCE			
ANG	TOL	DIM	TOL
.X	$\pm 3.0^{\circ}$.X	± 0.30
.XX	$\pm 2.0^{\circ}$.XX	± 0.20
.XXX	$\pm 1.0^{\circ}$.XXX	± 0.10

NOTE: ALL RIGHTS RESERVED, BANNED COPY!

DRAWING TYPE

CUSTOMER DRAWING

MARK

DATE

DESCRIPTION

DESIGN

A

2020.05.06

PROPOSAL

CHEN

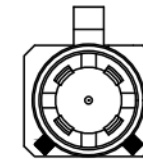
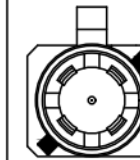
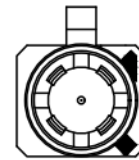
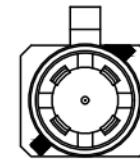
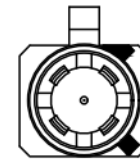
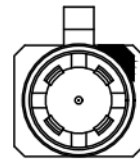
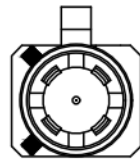
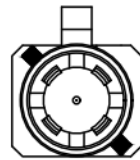
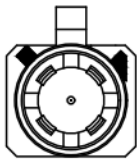
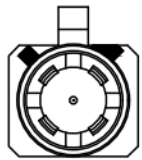
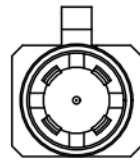
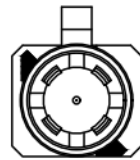
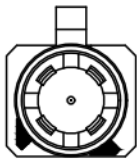
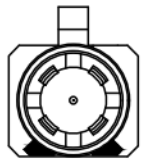
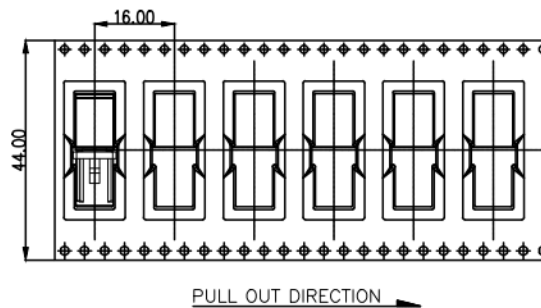
KH-FAKRA-
A-CBKH-FAKRA-
B-CBKH-FAKRA-
C-CBKH-FAKRA-
D-CBKH-FAKRA-
E-CBKH-FAKRA-
F-CBKH-FAKRA-
G-CBKH-FAKRA-
H-CBKH-FAKRA-
I-CBKH-FAKRA-
K-CBKH-FAKRA-
L-CBKH-FAKRA-
M-CBKH-FAKRA-
N-CBKH-FAKRA-
Z-CB

NOTE:
1.PER REEL: 400PCS

NOTE: ALL RIGHTS RESERVED,BANNED COPY!

UNLESS OTHERWISE
SPECIFIED TOLERANCE

ANG	TOL	DIM	TOL
.X	±3.0°	.X	±0.30
.XX	±2.0°	.XX	±0.20
.XXX	±1.0°	.XXX	±0.10

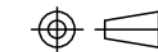

DRAWING NO

7.03A0-C

PART NAME:

FAKRA LOW PROFILE CONNECTOR
CUSTOMER DRAWING

PART NO.

7.03A0.00089X

DATE

2020.05.06

UNITS

mm

SCALE

4:1

PAGE

2/2

REV

A

APPROVED

VERIFIED

DESIGN

CHEN

深圳市金航标电子有限公司

www.kinghelm.com.cn

KH-FAKRA-H-CB

0755-28190160

DRAWING TYPE PACKAGE DRAWING

MARK	DATE	DESCRIPTION	DESIGN
A	2020.05.06	PROPOSAL	CHEN

NOTES:

- MATERIAL:
 - CARRY TAPE:HIPS,T=0.50±0.05mm,BLACK
 - REEL:HIPS,
 - SHIM:PE,CLEAR.
- PRIMARY PACKING:400PCS/REEL.
- SECONDARY PACKING:SEE PACKING LIST
- PEELING RESISTANCE: 0.2~1.2N(20~120gf); PEELING ANGLE: 165°~180°; PEELING SPEED: 300mm/minutes.

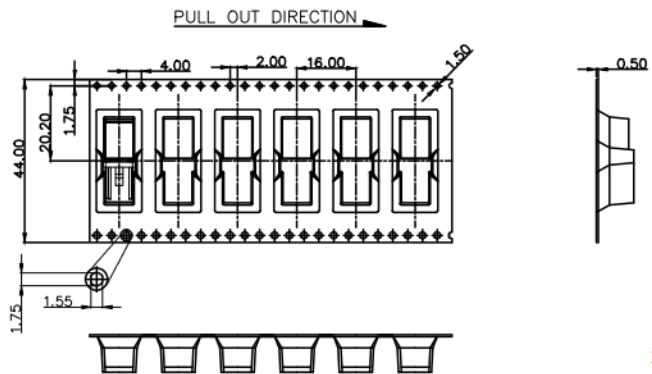

PER REEL with PE Bag

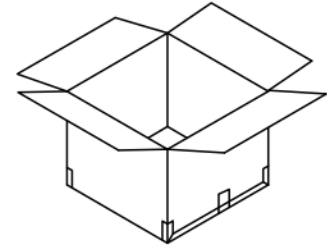
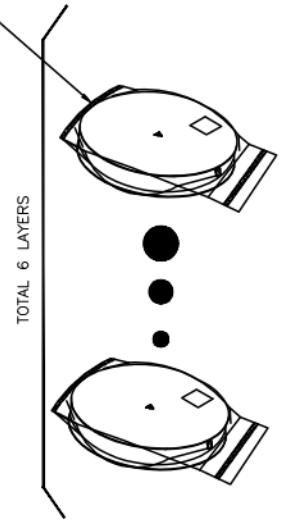

6 REEL PER CARTON
Total 2400 PCS

TRANSPARENT GULE TAPE

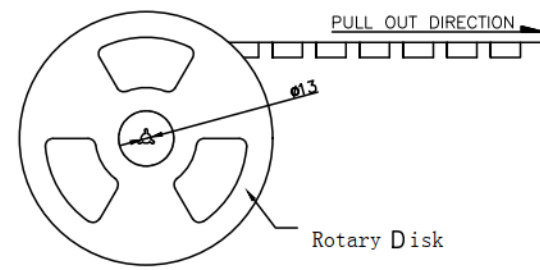
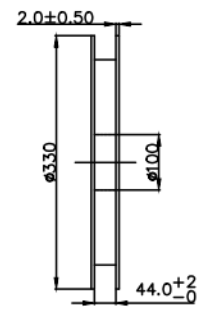
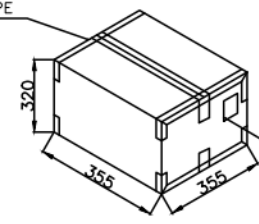

Rotary Disk

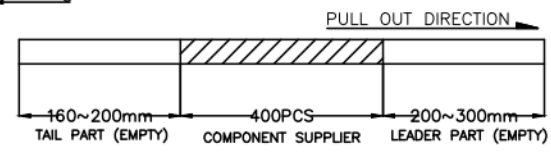

深圳市金航标电子有限公司		www.kinghelm.com.cn			
KH-FAKRA-H-CB		0755-28190160			
UNLESS OTHERWISE SPECIFIED TOLERANCE		DRAWING NO	PART NAME: FAKRA LOW PROFILE CONNECTOR PACKING DRAWING		
		7.03A0-P	PART NO. 7.03A0.00089X		
ANG	TOL	DIM	TOL	DATE	UNITS
.X	±3.0°	.X	±0.20	2020.05.06	mm
.XX	±2.0°	.XX	±0.10	SCALE	PAGE
.XXX	±1.0°	.XXX	±0.05	1:1	1/1
APPROVED		DESIGN	REV		
		CHEN	A		

NOTE: ALL RIGHTS RESERVED,BANNED COPY!

X-ON Electronics

Largest Supplier of Electrical and Electronic Components

Click to view similar products for [RF Connectors / Coaxial Connectors](#) category:

Click to view products by [Kinghelm](#) manufacturer:

Other Similar products are found below :

[8915-1511-000](#) [89674-0827](#) [6002-7051-003](#) [6059674-1](#) [630059-000](#) [M39030/3-01N](#) [6501-1071-002](#) [6769](#) [7002-1572-002](#) [7003-1542-011](#)
[7003-1572-002](#) [7004-1512-000](#) [7009-1511-004](#) [7101-1541-010](#) [7105-1521-002](#) [7145-1521-002](#) [7203-1571-003](#) [7209-1511-011](#) [7210-1511-](#)
[040](#) [7242-1511-000](#) [73216-2241](#) [73404-2300](#) [7405-1521-005](#) [7405-1521-802](#) [8527](#) [8547](#) [FS11V](#) [8808-1511-001](#) [9074-9513-000](#) [PL11C-](#)
[026](#) [PL40-5](#) [PL71-9](#) [PL74C-221](#) [9408-1113-000](#) [980-8666-005](#) [1200690078](#) [1-201144-1](#) [120919](#) [R107003010W](#) [R112186000](#)
[R113053000W](#) [R113082097](#) [R113236000](#) [R113240000](#) [R113240097](#) [R114083000](#) [R114670000W](#) [R123415000W](#) [R124072220W](#)
[R124076320](#)