

| 版次(Edition) | 变更摘要(Change The Content) | 日期(Date) |
|-------------|--------------------------|------------|
| 1 | 增加料号说明 | 2015/1/28 |
| 2 | 电镀方式由全金升级为点镀金 | 2021/12/02 |

| 序号(NO.) | 品名(Name) | 材质(Material) |
|---------|--|--|
| ① | 0.5掀盖胶芯(H=2.0) 0.5 Pitch Easy-on Type Housing (H=2.0) | LCP UL94V-0 本色 Natural |
| ② | 0.5掀盖端子(H=2.0) 0.5 Pitch Easy-on Type Terminal (H=2.0) | 铜合金/表面镀锡 Copper Alloy/ Tin Plating |
| ③ | 0.5掀盖后盖(H=2.0) 0.5 Pitch Easy-on Type Actuator (H=2.0) | LCP UL94V-0 黑色 Black |
| ④ | 0.5掀盖焊片(H=2.0) 0.5 Pitch Easy-on Type Fitting Nail (H=2.0) | 铜合金/表面镀锡 Copper Alloy/ Tin Plating |

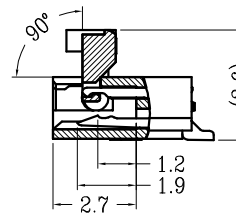

SECTION A-A

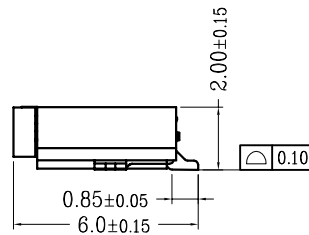
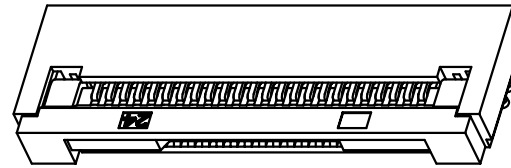
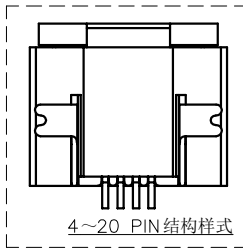
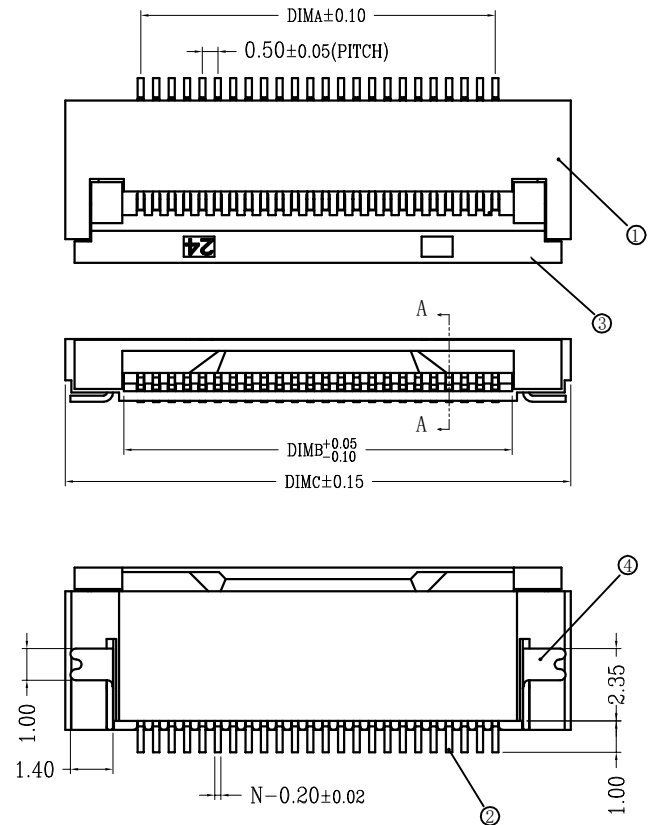
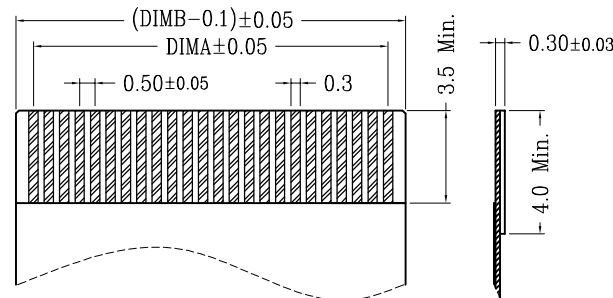

适用扁平线(Applicable Flat Cable)

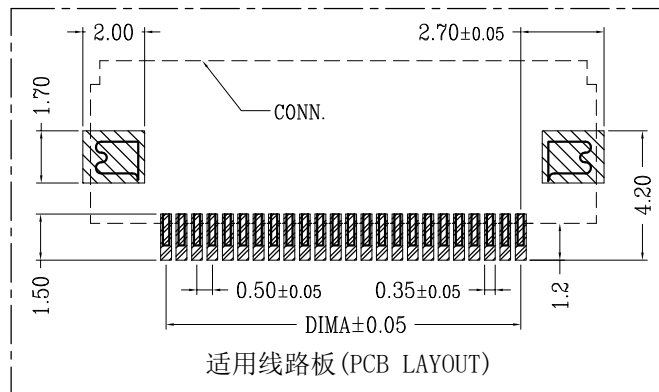

| CKT | DIMA | DIMB | DIMC | CKT | DIMA | DIMB | DIMC |
|-----|-------|-------|-------|-----|-------|-------|-------|
| 4 | 1.50 | 2.60 | 6.40 | 34 | 16.50 | 17.60 | 21.40 |
| 5 | 2.00 | 3.10 | 6.90 | 35 | 17.00 | 18.10 | 21.90 |
| 6 | 2.50 | 3.60 | 7.40 | 36 | 17.50 | 18.60 | 22.40 |
| 7 | 3.00 | 4.10 | 7.90 | 37 | 18.00 | 19.10 | 22.90 |
| 8 | 3.50 | 4.60 | 8.40 | 38 | 18.50 | 19.60 | 23.40 |
| 9 | 4.00 | 5.10 | 8.90 | 39 | 19.00 | 20.10 | 23.90 |
| 10 | 4.50 | 5.60 | 9.40 | 40 | 19.50 | 20.60 | 24.40 |
| 11 | 5.00 | 6.10 | 9.90 | 41 | 20.00 | 21.10 | 24.90 |
| 12 | 5.50 | 6.60 | 10.40 | 42 | 20.50 | 21.60 | 25.40 |
| 13 | 6.00 | 7.10 | 10.90 | 43 | 21.00 | 22.10 | 25.90 |
| 14 | 6.50 | 7.60 | 11.40 | 44 | 21.50 | 22.60 | 26.40 |
| 15 | 7.00 | 8.10 | 11.90 | 45 | 22.00 | 23.10 | 26.90 |
| 16 | 7.50 | 8.60 | 12.40 | 46 | 22.50 | 23.60 | 27.40 |
| 17 | 8.00 | 9.10 | 12.90 | 47 | 23.00 | 24.10 | 27.90 |
| 18 | 8.50 | 9.60 | 13.40 | 48 | 23.50 | 24.60 | 28.40 |
| 19 | 9.00 | 10.10 | 13.90 | 49 | 24.00 | 25.10 | 28.90 |
| 20 | 9.50 | 10.60 | 14.40 | 50 | 24.50 | 25.60 | 29.40 |
| 21 | 10.00 | 11.10 | 14.90 | 51 | 25.00 | 26.10 | 29.90 |
| 22 | 10.50 | 11.60 | 15.40 | 52 | 25.50 | 26.60 | 30.40 |
| 23 | 11.00 | 12.10 | 15.90 | 53 | 26.00 | 27.10 | 30.90 |
| 24 | 11.50 | 12.60 | 16.40 | 54 | 26.50 | 27.60 | 31.40 |
| 25 | 12.00 | 13.10 | 16.90 | 55 | 27.00 | 28.10 | 31.90 |
| 26 | 12.50 | 13.60 | 17.40 | 56 | 27.50 | 28.60 | 32.40 |
| 27 | 13.00 | 14.10 | 17.90 | 57 | 28.00 | 29.10 | 32.90 |
| 28 | 13.50 | 14.60 | 18.40 | 58 | 28.50 | 29.60 | 33.40 |
| 29 | 14.00 | 15.10 | 18.90 | 59 | 29.00 | 30.10 | 33.90 |
| 30 | 14.50 | 15.60 | 19.40 | 60 | 29.50 | 30.60 | 34.40 |
| 31 | 15.00 | 16.10 | 19.90 | 61 | 30.00 | 31.10 | 34.90 |
| 32 | 15.50 | 16.60 | 20.40 | 64 | 31.50 | 32.60 | 36.40 |
| 33 | 16.00 | 17.10 | 20.90 | 65 | 32.00 | 33.10 | 36.90 |

技术指标(Technical Index):

1. 塑件表面应光洁、无毛边、无明显收缩、缺陷、裂纹等现象。(The surface of the plastic parts should be smooth, no rough edges, no obvious shrinkage, defects, cracks and other phenomena.)
2. 温度范围(Temperature range): -25° C~85° C.
3. 额定电压(Rated voltage): 50V, AC/DC(=等效).
4. 接触电阻(Contact resistance): ≤0.03 Ω.
5. 绝缘电阻(Insulation resistance): ≥500M Ω.
6. 产品料号(Product material No.):



一般公差(TOLERANCE)
 X ±.50 .XX ±.10
 X ±.20 .XXX ±.05
 ANGLES ±1°

| | | | |
|-----------------------|--|----------------------|--------|
| 深圳市金航标电子有限公司 | | www.kinghel.m.com.cn | |
| KH-FG0.5-H2.0-18P-SMT | | 0755-28190160 | |
| 品名(TITLE) | 0.5 Pitch掀盖卧式下接(H=2.0) 0.5 Pitch H2.0 Easy-on R/A Down Type CONN. | 制图(DR) | Anlan |
| 料号(DWG.NO) | XW05202-****-** | 校对(CHKC) | 李绍宗 |
| 比例(SCALE) | 1:1 | 审核(APPD) | 黄志明 |
| 单位(UNITS) | mm | 张数(SHEET) | 1 OF 1 |
| | | 尺寸(SIZE) | A4 |
| | | REV | A |

X-ON Electronics

Largest Supplier of Electrical and Electronic Components

Click to view similar products for [FFC & FPC Connectors](#) category:

Click to view products by [Kinghelm](#) manufacturer:

Other Similar products are found below :

[00-6200-227-022-800](#) [006205250500825+](#) [006205280500825+](#) [FPH-1602G](#) [086222026001800](#) [52610-0675](#) [62674-201121DLF](#) [52746-1671-TR250](#) [10051922-1610EHLF](#) [10051922-2810EHLF](#) [686322124422](#) [XF3M-2915-1B-R100](#) [AYF353125A](#) [AYF530665TA](#) [AYF534065TA](#) [20FLH-RSM1-TB](#) [207356-1](#) [SFW12R-5STE9LF](#) [SFW18R-1STAE9LF](#) [SFW4R-5STE9LF](#) [52807-0430](#) [046283021002868+](#) [FFC05011-10SBB114W5M](#) [502250-8027](#) [67000-008LF](#) [200528-0260](#) [FH28K-10S-0.5SH](#) [FH52K-6S-0.5SH](#) [0.5K-DX-30PWB](#) [DS1020-08-10VBT12](#) [THD0515-34CL-GF](#) [X05A10L28G](#) [ECC2841061EU](#) [1.0K-DHQX-16PWB](#) [1.0K-DHQX-30PWB](#) [1775333-6](#) [10054365-202110ELF](#) [10054365-242110ELF](#) [10054365-282110ELF](#) [10064555-392220HLF](#) [59453-041110EBHLF](#) [59453-091110EDHLF](#) [62674-241141ALF](#) [62684-432100ALF](#) [62684-451100AHLF](#) [62684-5721N0ALF](#) [HFW11R-1STE1MTLF](#) [HFW12R-1STE9LF](#) [HFW14R-1STE9MTLF](#) [HFW18S-2STE9LF](#)