

SECTION A-A
Without cover

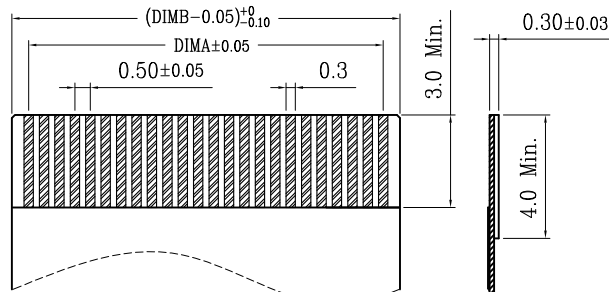
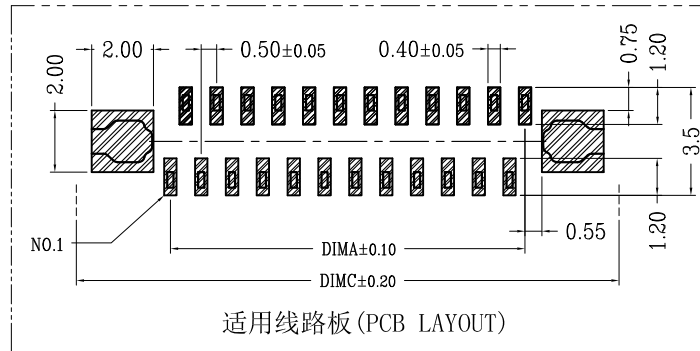
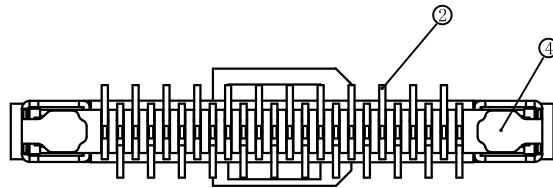
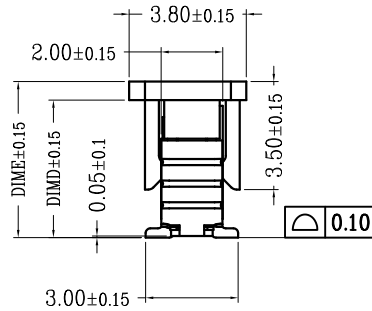
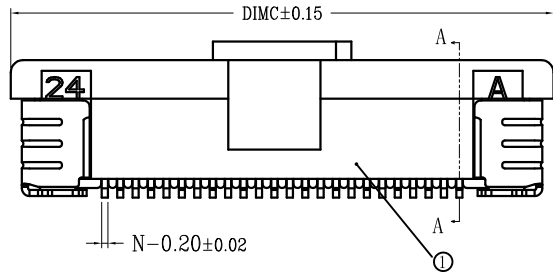
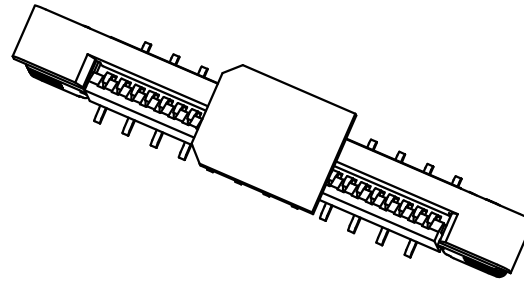

适用扁平线 (Applicable Flat Cable)

版次	变更摘要	日期
1	增加料号说明	2015/1/28

序号	品名	材质
①	0.5拉拔3代胶芯 (H2.0)	LCP UL94V-0 本色
②	0.5拉拔立式端子	铜合金/表面镀锡
③	0.5拉拔卧式3代后盖	LCP UL94V-0 黑色
④	0.5拉拔3代焊片 (H2.0)	铜合金/表面镀锡
⑤	0.5拉拔立式3代吸盖	LCP UL94V-0 黑色

CKT	DIM A	DIM B	DIM C	DIM D	DIM E
6	2.50	3.56	8.60		
7	3.00	4.06	9.10		
8	3.50	4.56	9.60		
9	4.00	5.06	10.10		
10	4.50	5.56	10.60		
11	5.00	6.06	11.10		
12	5.50	6.56	11.60		
13	6.00	7.06	12.10		
14	6.50	7.56	12.60		
15	7.00	8.06	13.10		
16	7.50	8.56	13.60		
17	8.00	9.06	14.10		
18	8.50	9.56	14.60		
19	9.00	10.06	15.10		
20	9.50	10.56	15.60	4.45	5.05
21	10.00	11.06	16.10		
22	10.50	11.56	16.60		
23	11.00	12.06	17.10		
24	11.50	12.56	17.60		
25	12.00	13.06	18.10		
26	12.50	13.56	18.60		
27	13.00	14.06	19.10		
28	13.50	14.56	19.60		
29	14.00	15.06	20.10		
30	14.50	15.56	20.60		
31	15.00	16.06	21.10		
32	15.50	16.56	21.60		
33	16.00	17.06	22.10		
34	16.50	17.56	22.60		

技术指标:

1. 塑件表面应光洁、无毛边、无明显收缩、缺陷、裂纹等现象。
2. 温度范围: -25° C~85° C.
3. 额定电压: 50V, AC/DC(等效).
4. 接触电阻: ≤0.03Ω.
5. 绝缘电阻: ≥500MΩ
6. 产品料号:



一般公差 (TOLERANCE)
X ±.50 XX ±.10
X ±.20 XXX ±.05
ANGLES ±1°

深圳市金航标电子有限公司 www.kinghelm.com.cn
KH-FPC0.5-H5.0-22P-LTQB 0755-28190160

品名 (TITLE) 0.5 Pitch 拉拔立式3代正脚位1代 制图 (DR) Anlan
料号 (DWG.NO) FP218H-0xxS10M 审核 (APPD) 黄志明
校对 (CHKD) 王涛

比例 (SCALE) 1:1 单位 (UNITS) mm 张数 (SHEET) 1 OF 2 SIZE REV A4 A

X-ON Electronics

Largest Supplier of Electrical and Electronic Components

Click to view similar products for [FFC & FPC Connectors](#) category:

Click to view products by [Kinghelm](#) manufacturer:

Other Similar products are found below :

[00-6200-227-022-800](#) [006205250500825+](#) [006205280500825+](#) [FPH-1602G](#) [086222026001800](#) [52610-0675](#) [62674-201121DLF](#) [52746-1671-TR250](#) [10051922-1610EHLF](#) [10051922-2810EHLF](#) [686322124422](#) [XF3M-2915-1B-R100](#) [AYF353125A](#) [AYF530665TA](#) [AYF534065TA](#) [20FLH-RSM1-TB](#) [207356-1](#) [SFW12R-5STE9LF](#) [SFW18R-1STAE9LF](#) [SFW4R-5STE9LF](#) [52807-0430](#) [046283021002868+](#) [FFC05011-10SBB114W5M](#) [502250-8027](#) [67000-008LF](#) [200528-0260](#) [FH28K-10S-0.5SH](#) [FH52K-6S-0.5SH](#) [0.5K-DX-30PWB](#) [DS1020-08-10VBT12](#) [THD0515-34CL-GF](#) [X05A10L28G](#) [ECC2841061EU](#) [1.0K-DHQX-16PWB](#) [1.0K-DHQX-30PWB](#) [1775333-6](#) [10054365-202110ELF](#) [10054365-242110ELF](#) [10054365-282110ELF](#) [10064555-392220HLF](#) [59453-041110EBHLF](#) [59453-091110EDHLF](#) [62674-241141ALF](#) [62684-432100ALF](#) [62684-451100AHLF](#) [62684-5721N0ALF](#) [HFW11R-1STE1MTLF](#) [HFW12R-1STE9LF](#) [HFW14R-1STE9MTLF](#) [HFW18S-2STE9LF](#)