

REV	DESCRIPTION	DWN	DATE	APPROVEN
A	FIRST ISSUE	XIEFENG	2022/06/15	Mr.chen

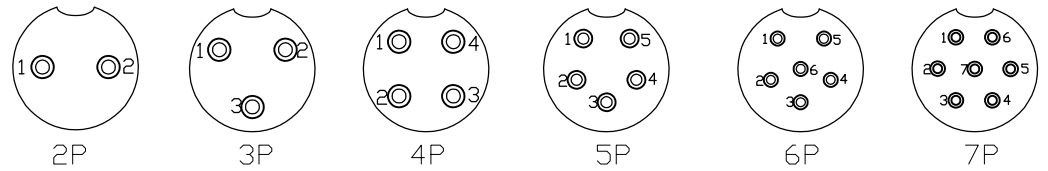
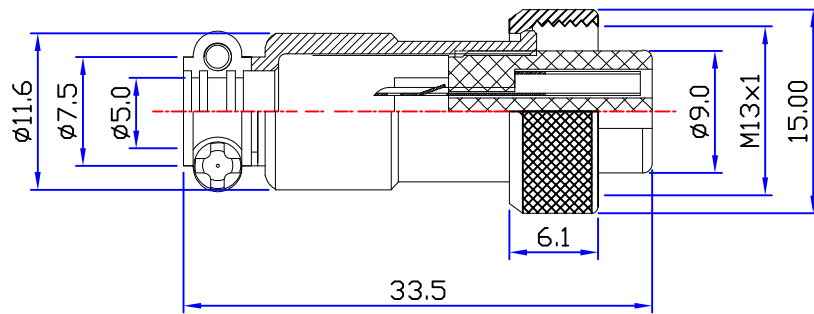

Material and specifications

Coupling Threaded coupling
 Shell material Zinc alloy with Nickel Plate
 Insert material bakelite
 Contact material copper Silver Plate/Nickel
 Termination Solder
 Mating cycle 500
 Cable diameter -20℃ +85℃

Technology parameter						
NO.of contacts	2	3	4	5	6	7
Rated current (A)	5	5	5	5	5	5
Operation limit voltage(AC.V.rms)	200	125	125	125	125	125
Withstanding voltage(AC.V.rms) 1 minute	1500	1500	1500	1500	1500	1500
Insulation resistance(mΩ)	2000	2000	2000	2000	2000	2000
Contact resistance (mΩ)	5	5	5	5	5	5
Solder cup mouth aperture	∅0.8	∅0.8	∅0.8	∅0.8	∅0.8	∅0.8
Solder inter diameter	∅1.2	∅1.2	∅1.2	∅1.2	∅1.2	∅1.2

NOTE:		Tolerance	UNLESS OTHERWISE SPECIFIED TOLERANCES FOR INCHES ARE 0.5-8MM±0.10MM 8-30MM±0.15MM 30-120MM±0.20MM	深圳市金航标电子有限公司		www.kinghelm.com.cn	
DRAWN: XIEFENG	DATE: 22/06/15			SHENZHEN KINGHELM ELECTRON CO.,LTD.		0755-28190160	
CHECKED:		VIEW		Name: GX12 FEMALE CONNECTOR			
APPROVALS:		UNIT	MM	Product NO. KH-GX12-6P			REV A
		SCALE	1 : 1	CAD FILE H/companydrawings/BD			SHEET: 1 OF 1

REV	DESCRIPTION	DWN	DATE	APPROVEN
A	FIRST ISSUE	XIEFENG	2022/06/15	Mr.chen

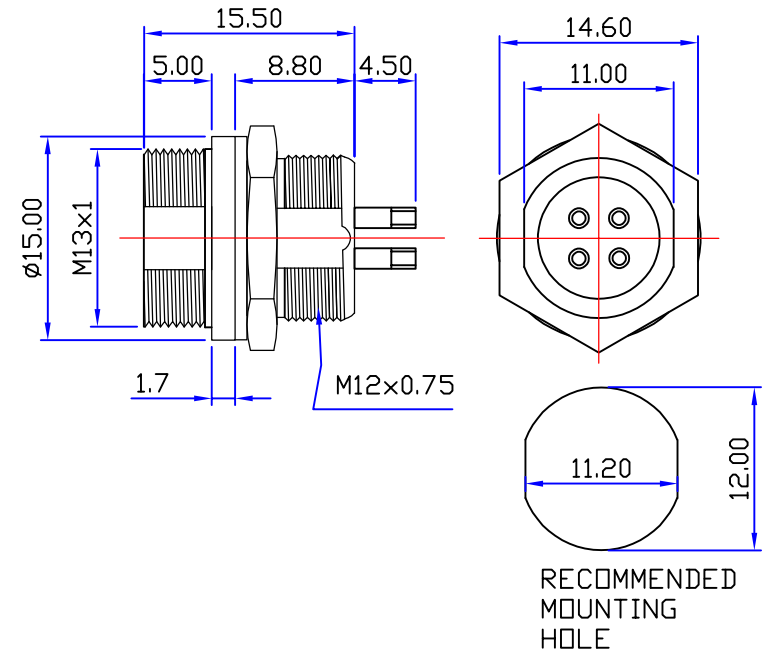
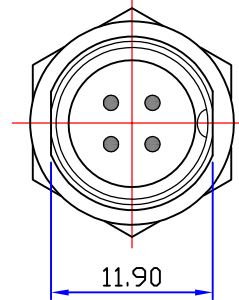
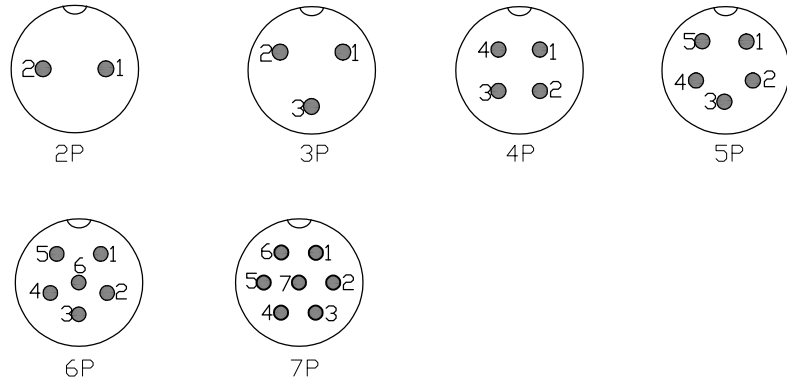

Material and specifications

Coupling	Threaded coupling
Shell material	Brass with Nickel Plate
Insert material	bakelite
Contact material	copper Silver Plate/Nickel
Termination	Solder
Mating cycle	500
Cable diameter	-20℃ +85℃

Technology parameter						
NO.of contacts	2	3	4	5	6	7
Rated current (A)	5	5	5	5	5	5
Operation limit voltage(AC.V.rms)	200	125	125	125	125	125
Withstanding voltage(AC.V.rms) 1 minute	1500	1500	1500	1500	1500	1500
Insulation resistance (mΩ)	2000	2000	2000	2000	2000	2000
Contact resistance (mΩ)	5	5	5	5	5	5

NOTE:		Tolerance	UNLESS OTHERWISE SPECIFIED TOLERANCES FOR DIMENSIONS ARE 0.5-8MM±0.10MM 8-30MM±0.15MM 30-120MM±0.20MM	深圳市金航标电子有限公司		www.kinghelm.com.cn	
DRAWN: XIEFENG	DATE: 22/06/15			SHENZHEN KINGHELM ELECTRON CO.,LTD.		0755-28190160	
CHECKED:		VIEW		Name: GX12 MALE CONNECTOR			
APPROVALS:		UNIT	MM	Product NO. KH-GX12-6P			REV A
		SCALE	1 : 1	CAD FILE H/companydrawings/BD			SHEET: 1 OF 1

X-ON Electronics

Largest Supplier of Electrical and Electronic Components

Click to view similar products for [Standard Circular Connector](#) category:

Click to view products by [Kinghelm](#) manufacturer:

Other Similar products are found below :

[600273N007](#) [6134-336-13149](#) [6134-337-11149](#) [6134-337-2390](#) [6134-341-17149](#) [67-02E12-60PX](#) [680-SMG](#) [CXS3102A181S](#)
[D38999/20FC8SA L/C](#) [75-190216-08S](#) [75-190611-03S](#) [75-474014-05S](#) [75-474618-04S](#) [75-474620-07P](#) [799539-000](#) [805-005-07NF11-19PC](#)
[805-005-07NF15-7PA](#) [FMP.2M.310.XLCT](#) [836783-1](#) [862256-1](#) [866857-1](#) [867865-1](#) [PT08P-14-19S](#) [PT08P-14-5S](#) [QCM019PC2DC012B](#)
[121583-0217](#) [121667-0020](#) [RD10A16-19-P6CS051/1](#) [RD16A14-12-S6CS051/2](#) [1301240268](#) [1301240275](#) [1301860906](#) [DCU-08BFEA-](#)
[LL7001](#) [RM15WTP-CP\(5\)\(71\)](#) [14482](#) [16283-18](#) [1877910-1](#) [206039-3](#) [206323-1](#) [207002-2](#) [207682-1](#) [CA06COME14SA7P](#) [211777-1](#) [JL04-](#)
[1012CK\(05\)-R](#) [JL04V-2A28-11PE-R](#) [JL04V-2E10SL-3PE-B-R](#) [JL04V-2E20-15PE-B-R](#) [JL04V-2E20-4PE-B-R](#) [JL04V-2E24-10PE\(G\)-B-R](#)
[JL04V-6A24-11SE-EB-R](#)