

CUSTOMER

REV. 版本	MODIFICATION. 变更内容	DRAWN/DATE 设计/日期
X1	初版发行	
B	图面整理	Frank 2015.05.19

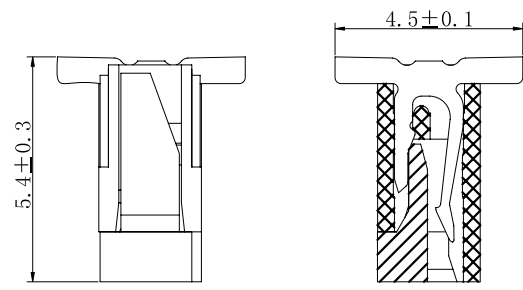
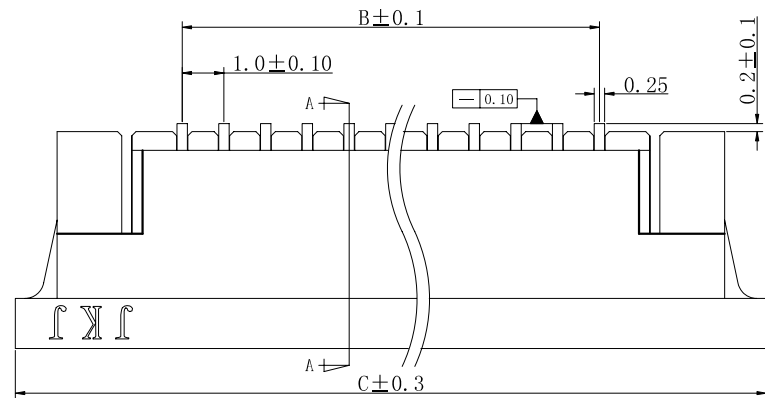

新料号 1027A0-\*\*\*-\*\*\*

0: 不加盖  
1: 加盖

1: LCP 2: PA9T  
D: 袋装 G: 管装 P: 盘装  
1: 雾锡 3: 镀金

PIN数

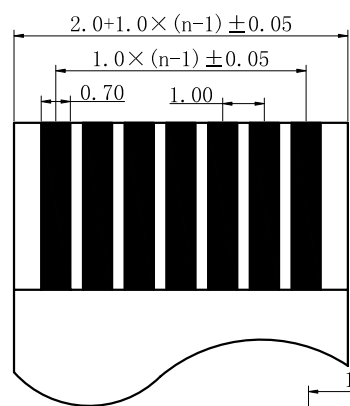
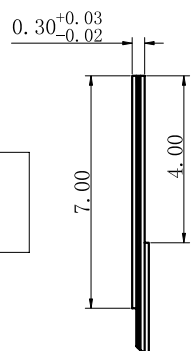
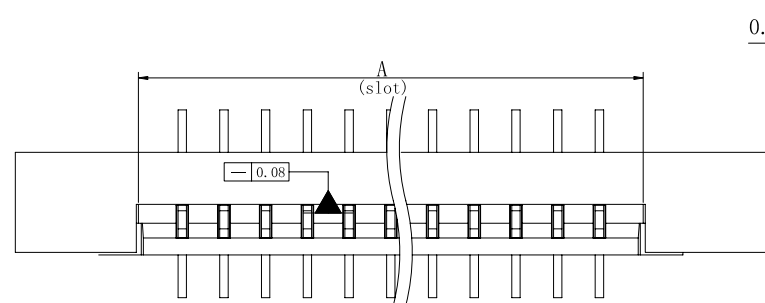

NO. of Contacts (n)	Dimensions		
	A	B	C
004	5.07	3.0	11.0
005	6.07	4.0	12.0
006	7.07	5.0	13.0
007	8.07	6.0	14.0
008	9.07	7.0	15.0
009	10.07	8.0	16.0
010	11.07	9.0	17.0
011	12.07	10.0	18.0
012	13.07	11.0	19.0
013	14.07	12.0	20.0
014	15.07	13.0	21.0
015	16.07	14.0	22.0
016	17.07	15.0	23.0
017	18.07	16.0	24.0
018	19.07	17.0	25.0
019	20.07	18.0	26.0
020	21.07	19.0	27.0
021	22.07	20.0	28.0
022	23.07	21.0	29.0
023	24.07	22.0	30.0
024	25.07	23.0	31.0
025	26.07	24.0	32.0
026	27.07	25.0	33.0
027	28.07	26.0	34.0
028	29.07	27.0	35.0
029	30.07	28.0	36.0
030	31.07	29.0	37.0
031	32.07	30.0	38.0
032	33.07	31.0	39.0

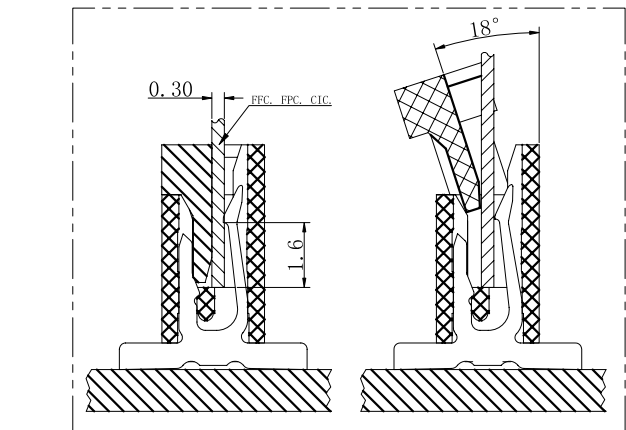

Electrical

Voltage: 50 V AC(rms)/DC  
 Current: 1 A AC(rms)/DC  
 Contact Resistance: 40 mΩ max(initial)  
 Dielectric Withstanding Voltage: 200 V AC/rms  
 Insulation Resistance: 500 MΩ min  
 Operating Temp: -40° C ~ +85° C

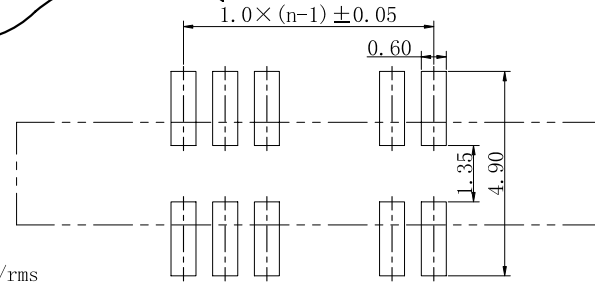

GENERAL TOLERANCE	ANGLE TOLERANCE	DESIGN. Frank 设计 2015.05.19	深圳市金航标电子有限公司 www.kinghelm.com.cn	
X. ±0.30 .X ±0.25 .XX ±0.15 .XXX ±0.10	X' ±5.0° .X' ±3.0° .XX' ±2.0°	CHECKED. 审核	KH-LF1.0-H5.4-4P 0755-28190160	
UNIT:mm	SCALE 1:1	APPROVED. 核准	FILE NAME. 品名	FPC1.0拉拔式立贴
A4	SHEET:1of1		PART NUMBER. 料号	1027A0-***-***
			MDRAWING NO. 图号	1027A0
				REV. B

## X-ON Electronics

Largest Supplier of Electrical and Electronic Components

*Click to view similar products for [FFC & FPC Connectors](#) category:*

*Click to view products by [Kinghelm](#) manufacturer:*

Other Similar products are found below :

[00-6200-227-022-800](#) [006205250500825+](#) [006205280500825+](#) [FPH-1602G](#) [086222026001800](#) [52610-0675](#) [62674-201121DLF](#) [52746-1671-TR250](#) [10051922-1610EHLF](#) [10051922-2810EHLF](#) [686322124422](#) [XF3M-2915-1B-R100](#) [AYF353125A](#) [AYF530665TA](#) [AYF534065TA](#) [20FLH-RSM1-TB](#) [207356-1](#) [SFW12R-5STE9LF](#) [SFW18R-1STAE9LF](#) [SFW4R-5STE9LF](#) [52807-0430](#) [046283021002868+](#) [FFC05011-10SBB114W5M](#) [502250-8027](#) [67000-008LF](#) [200528-0260](#) [FH28K-10S-0.5SH](#) [FH52K-6S-0.5SH](#) [0.5K-DX-30PWB](#) [DS1020-08-10VBT12](#) [THD0515-34CL-GF](#) [X05A10L28G](#) [ECC2841061EU](#) [1.0K-DHQX-16PWB](#) [1.0K-DHQX-30PWB](#) [1775333-6](#) [10054365-202110ELF](#) [10054365-242110ELF](#) [10054365-282110ELF](#) [10064555-392220HLF](#) [59453-041110EBHLF](#) [59453-091110EDHLF](#) [62674-241141ALF](#) [62684-432100ALF](#) [62684-451100AHLF](#) [62684-5721N0ALF](#) [HFW11R-1STE1MTLF](#) [HFW12R-1STE9LF](#) [HFW14R-1STE9MTLF](#) [HFW18S-2STE9LF](#)