

REV.	DESCRIPTION	APPD	DATE

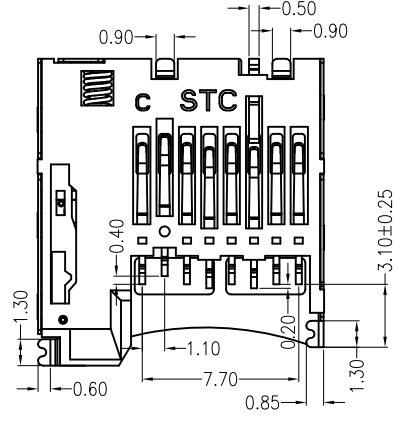

- NOTES:
- MATERIAL:
 - HOUSING: HIGH TEMPERATURE THERMOPLASTIC UL94V_0,COLOR:BLACK.
 - CONTACT: COPPER ALLOYS.
 - COVER: COPPER ALLOYS OR STEEL.
 - PLATING:
 - UNDERPLATE: NICKEL.
 - CONTACT AREA: GOLD OVER NICKEL.
 - SOLDER AREA: TIN OVER NICKEL.
 - MULTIMEDIA CARD COMPATIBLE

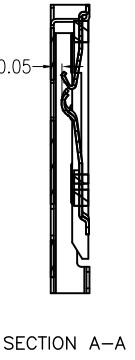
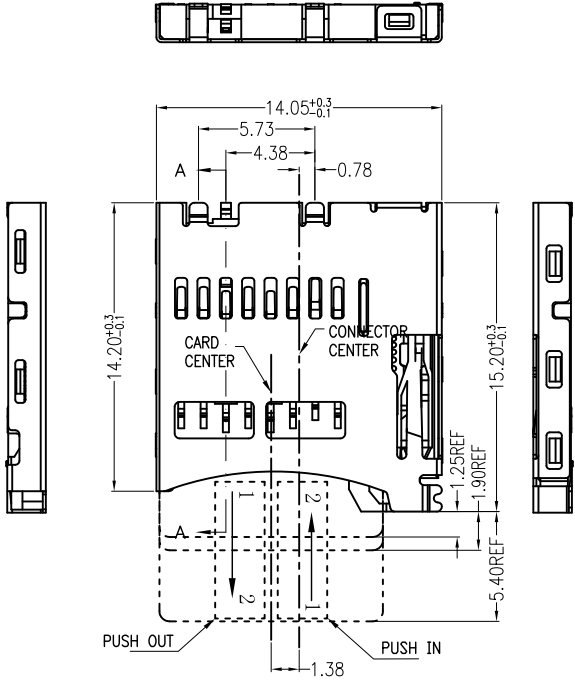
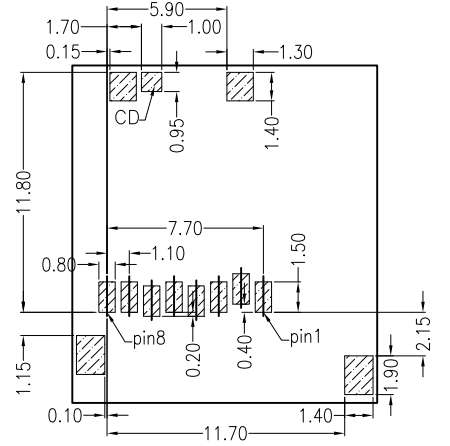
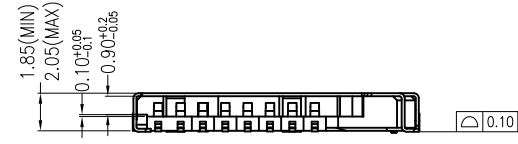
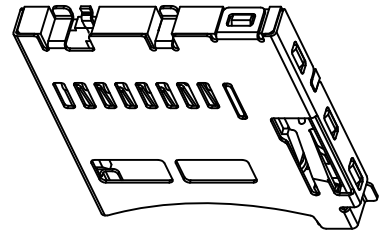

RECOMMENDED P.C.B HOLE LAYOUT COMPONENT SIDE VIEW(TOLERANCE: +/-0.05)

PIN NO.	NAME	YTYPE	DESCRIPTION
1	DAT2	I/O/PP	DATE LINE(BIT2)
2	CD/DAT3	I/O/PP	CARD DETECT DATE LIN(BIT3)
3	CMD	PP	COMMAND RESPONSE
4	VDD	S	SUPPLY VOLTAGE
5	CLX	I	CLOCK
6	VSS	S	SUPPLY VOLTAGE GROUND
7	DAT0	I/O/PP	DATE LINE(BIT0)
8	DAT1	I/O/PP	DATE LINE(DIT1)

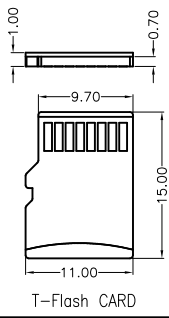

PART NO: TFN31-S1S1-2000-A		MATERIAL:		深圳市金航标电子有限公司 www.kinghelm.com.cn	
MODEL NO:		FINISH:		KH-TF035 0755-28190160	
UNIT: MM	SIZE: A4	COLOR:		TITLE: T-FLASH内焊 PUSH C Type	
TOLERANCES: X.X=±0.35 X.XX=±0.25 X.XXX=±0.15		GENERAL ANGLE: X.X=±3.0° X.XX=±2.0°		DR:	DWG NO: FP-100069
APP:		CHK:	REV: B/1	SCALE: 1:1	SHEET: 1 OF 2

Autodesk Foxit PDF Editor 1.0.0 © 2004 Autodesk, Inc. All rights reserved. 由 Autodesk 教育版产品制作

Autodesk 教育版产品制作

X-ON Electronics

Largest Supplier of Electrical and Electronic Components

Click to view similar products for [Memory Card Connectors](#) category:

Click to view products by [Kinghelm](#) manufacturer:

Other Similar products are found below :

[6407-249V-25273P](#) [6407-249V-25343P](#) [6426-201-21343](#) [69.920.0553.0](#) [MCR60A-98D-2.54DSA\(70\)](#) [809180410000000](#) [DM3AT-SF-PEJM5\(41\)](#) [IC11S-BUR-PNEJL\(71\)](#) [C70210M0083692](#) [2041353-2](#) [308-DS1P0811-192](#) [HM2P09PDR360N9LF](#) [10014744-011TLF](#) [11327-001](#) [11327-002](#) [NX1-32T-KT3K\(05\)](#) [95622-003LF](#) [84648-056HLF](#) [CCM03-3109 B LFT](#) [MS3116J10-6PW](#) [2309923-1](#) [61126-050CAHLF](#) [GTFP08432B1HR](#) [G85D1160022HHR](#) [SCE2MSDZN76A121SN](#) [10014744-011ALF](#) [10014744-011LF](#) [10057542-1211FLF](#) [10067972-000LF](#) [10067972-050LF](#) [10122302-20110LF](#) [G85D1162022HHR](#) [TF-05A](#) [M6014-12](#) [XKNANO-1412](#) [SMN-304-ARP6](#) [MIS11-S1F1-2000-A](#) [SMN-308-ARSP7](#) [MCS-302S-KT1B](#) [SMN-308-ACSP7](#) [K-DYX-008](#) [K-DYX-004](#) [HYCW126-TF18-150B](#) [C7024-03](#) [SMO-1030](#) [MCS-110-KT](#) [SIM-217](#) [SNO-1355-KT](#) [SMO-1025-P10](#) [SIM-211S-P6](#)