

NOTES:

1. Rating:300V 15A;
2. Insulation Withstands Voltage: AC2000V/MIN
3. Insulation Resistance: 500MΩ or more at DC500V
4. Using Temperature Range: -40° C/+105° C
5. Screw Torque Vlaue:0. 4N.m
6. Suitable Electric Wire: 28~12AWG
7. "★" is the important dimension.

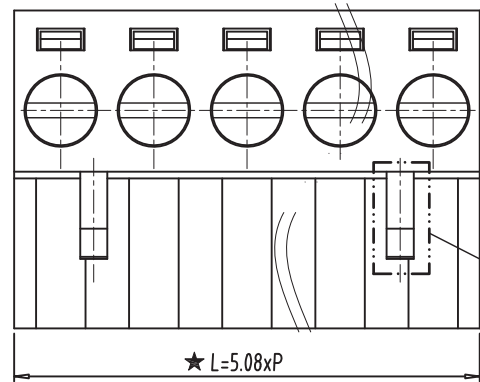

02P仅此卡勾

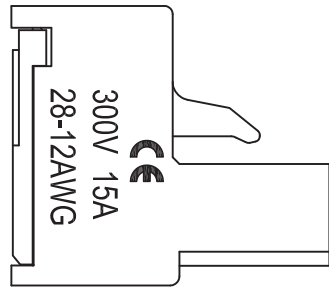
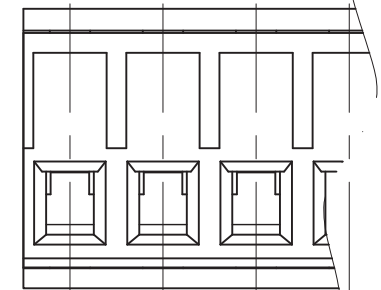
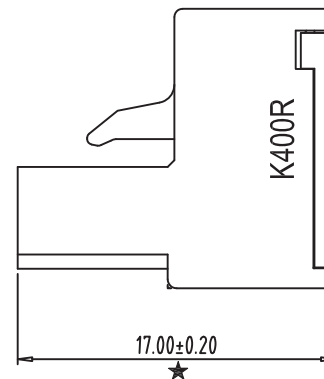
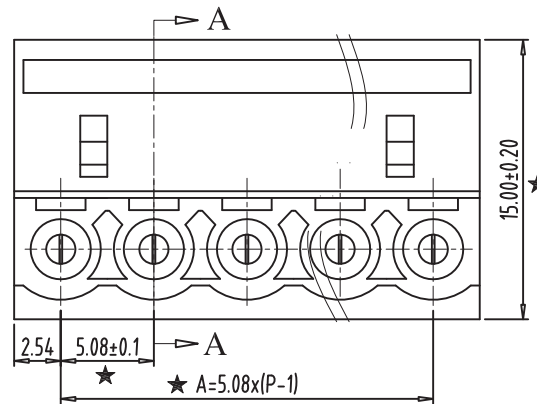
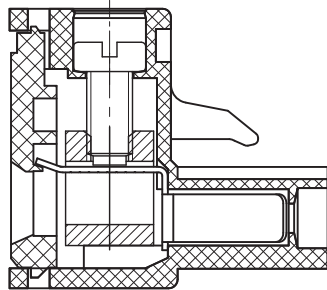

Total Pitch Tolerances in mm										Nominal dimension range in mm										⊥	≡	-	//
over 0 to 30	over 30 to 53	over 53 to 70	over 70 to 90	over 90 to 115	over 115 to 150	over 150 to 250	over 250 to 350	over 350 to 500	over 500 to 1000	over 0 to 30	over 30 to 53	over 53 to 70	over 70 to 90	over 90 to 115	over 115 to 150	over 150 to 200	over 200 to 250	over 250 to 320	over 0 to 10	over 10 to 100	over 100 to 150	over 150 to 200	
±0.18	? 0.20	±0.25	±0.3	±0.35	? 0.44	±0.60	±0.70	? 0.85	±0.20	±0.25	±0.30	±0.35	±0.44	±0.55	±0.70	±0.80	±0.90	0.2	0.3	0.3	0.2	0.3	0.5

ITEM	NAME OF PART	NO. OF PART	Q'TY	MATERIAL	NOTE
DWG.	DATE	2020/04/21	SIZE	A4 UNITS mm	SHEET/OF 1/1
CHK.	DATE		SCALE	2.5:1	2EDG-5.08
APP.	DATE				
深圳市金航标电子有限公司		www.kinghelm.com.cn		NAME	
KH-ZBK400R-8P-5.08GS		0755-28190160		DWGNO.	

X-ON Electronics

Largest Supplier of Electrical and Electronic Components

Click to view similar products for [Pluggable Terminal Blocks](#) category:

Click to view products by [Kinghelm](#) manufacturer:

Other Similar products are found below :

[57.510.0053](#) [721-104/026-047](#) [721-204/026-045](#) [MC 1.5/ 6-ST-3.5 GY AU](#) [ET02015000J0G](#) [860505](#) [860516](#) [860810](#) [GBPACX-12](#)
[93.731.4953.0](#) [PVP03-3,50](#) [PVS02-5,00](#) [1-1986160-3](#) [1377680000](#) [1531000000](#) [1546228-5](#) [ELFP03110](#) [ELFP10210](#) [ELFT07250](#)
[ELVD12100](#) [ELVF09400](#) [ELXH071G0E](#) [1725220000](#) [1760336](#) [1855000000](#) [19346](#) [1946309](#) [1973592](#) [19892](#) [25.320.4053.1](#) [25.320.4553.9](#)
[25.320.4753.1](#) [25.320.5453.1](#) [25.340.0353.1](#) [25.340.1053.1](#) [25.345.3553.0M001](#) [25.640.3553.1](#) [SH02-5,08](#) [SH06-3,81](#) [SH08-5,08](#) [SH08-](#)
[5,08-K](#) [SH12-5,08](#) [SHS04-5,00](#) [30.303](#) [30.305](#) [30.306](#) [PHP09-5,08](#) [25.193.0453.0](#) [25.320.4653.1](#) [25.332.2453.1](#)