

REV	MARK	DESCRIPTION	DRAFTED. BY	DATE

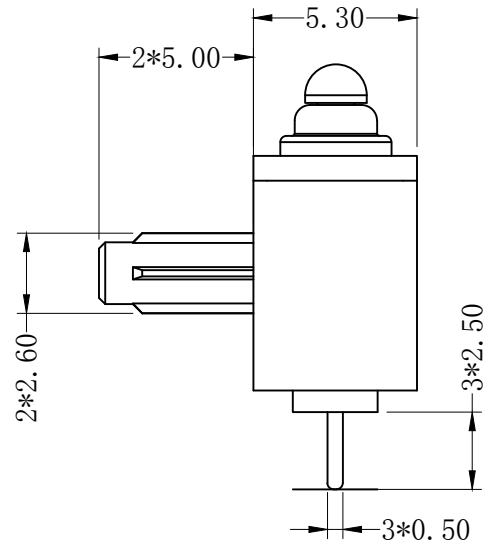

Circuit Diagram

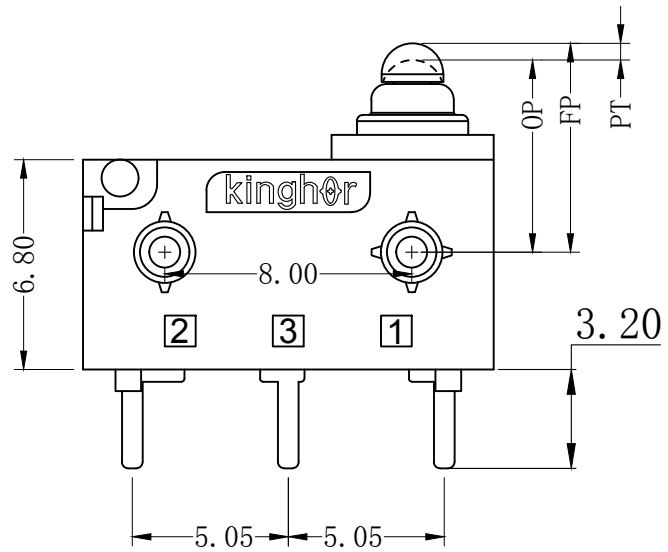
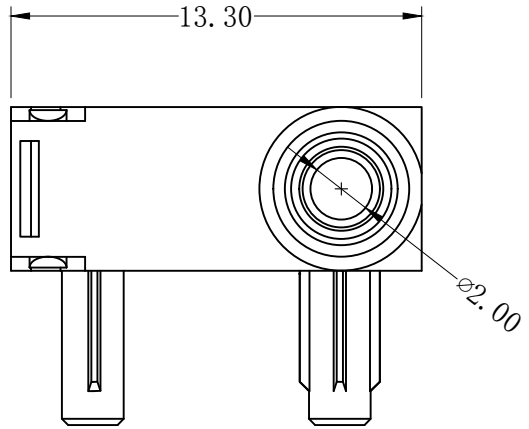
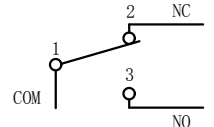

CHARACTERISTICS	
OPERATING FORCE (OF):	gf Max.
RELEASE FORCE (RF):	gf Min.
OPERATING POSITION:	6.40 ± 0.3 mm.
PRE TRAVEL:	1.30mm Max.
DIFFERENTIAL TRAVEL:	0.25mm Max.
FREE POSITION:	7.20mm Max.

ELECTRICAL DATA	
RATING	OPERATING LIFE
3A 12VDC	100,000 CYCLES
0.1A 48VDC 125/250VAC	100,000 CYCLES

MECHANICAL LIFE	500,000 CYCLES
GAP TYPE	MICRO
OPERATING TEMP	-40°C ~ +85°C
WATERPROOF	IP67(Except terminal)

OUTLINE DRAWING			
TITLE	H3 SERIES MICRO SWITCH		
MODEL	H3-D4		
PART NO.	H3-D4-1D00P		
DRAFTED BY	Bing Wang	DATE	2020-9-7
CHECKED BY	Hua Bai	DATE	2020-9-7
APPROVED BY	Hong Chen	DATE	2020-9-7

TOLERANCE UNLESS OTHERWISE SPECIFIED						
≤3	1~3	3~10	10~30	30~100	100~200	ANGLE
±0.2	±0.3	±0.4	±0.6	±1.0	±1.5	±3.0°
					SCALE	
					UNIT	mm
					VERSION	REV
						A1

KINGHOR
SWITCHES AND CONTROL EXPERT

X-ON Electronics

Largest Supplier of Electrical and Electronic Components

Click to view similar products for [Basic / Snap Action Switches](#) category:

Click to view products by [Kinghor](#) manufacturer:

Other Similar products are found below :

[5SM901-S12](#) [5SM9-S12N195](#) [602EN532](#) [602EN535-RB](#) [602HE5-RB1](#) [604HE223-6B](#) [624HE17-RB](#) [6HM82](#) [6SE1](#) [6SX1-H58](#) [71051](#) [714-0293](#) [MBH2731](#) [79211923](#) [79218589](#) [MIL30126AB6BBMD4A12XAU](#) [ML-1155](#) [ML-1376](#) [831010C3.0](#) [831090C2.EL](#) [83131904](#) [84212012](#) [8AS239](#) [8HM73-3](#) [8SX26-H33](#) [914CE1-6G](#) [11SM1077-H4](#) [11SM1077-H58](#) [11SM1-TN107](#) [11SM405](#) [11SM703-T](#) [11SM8423-H2](#) [11SX37-T](#) [11SX48-H58](#) [11SM2442-T](#) [11SM76-T](#) [11SM77-H58](#) [11SM77-T](#) [11SM863-T](#) [11SM866](#) [121EN188-R](#) [1245.0120](#) [125EN56-RB](#) [D433V3RD](#) [1267.0101](#) [1267.7101](#) [D4BFC1](#) [12SM4-T2](#) [12SX2-T2](#) [1298.0101](#)