

KL816

PHOTO TRANSISTOR

DIP4 晶体管光耦



* 本文档中包含的信息反映了具有代表性的使用场景，仅供技术参考。

The information contained in this document reflects representative usage scenarios and is intended for technical reference only.

* 本文档中提到的产品型号和规格如有更改或改进，恕不另行通知。在生产使用之前，客户应参考产品规格书的最新数据表。

Product models and specifications mentioned in this document are subject to change or improvement without notice. Customers should refer to the latest data sheets in the product specifications prior to production use.

* 在使用本文档中引用的产品时，请确保产品在数据手册中规定的环境和电气限制范围内运行。如果客户使用超过指定的限制，晶台将不会对任何后续问题负责。

When using the products referenced in this document, ensure that the products are operated within the environmental and electrical limits specified in the data sheet. If the customer uses the product beyond the specified limits, Kinglight will not be responsible for any subsequent problems.

* 本文档中的信息适用于电子元器件应用中的典型用法。如有任何特殊用途，请向晶台咨询，以获得进一步的帮助。

The information in this document applies to typical use in electronic component applications. For special applications, please contact Kinglight for further assistance.

* 未经晶台允许，不得复制或转载本文件的内容和信息。对于最新的信息，请参考官方网站 [Http://www.kinglight-OC.com](http://www.kinglight-OC.com)。

The contents and information in this document may not be copied or reproduced without the permission of Kinglight. For the latest information, please visit the official website [Http://www.kinglight-OC.com](http://www.kinglight-OC.com).

1. 产品特点 Product features

- 电流转换率(Current transfer ratio)
CTR: 50~600% at $I_F = 5\text{mA}$, $V_{CE} = 5\text{V}$
- 输入与输出高隔离电压(Viso=5000 V rms)
High isolation voltage between inputs and output (Viso=5000 V rms)
- tr/tf响应时间(在 $V_{CE}=2\text{V}$ 时, $I_C=2\text{mA}$, $R_L=100\Omega$, tr Typ.4us、tf Typ.3us)
Response time(tr Typ.4us、tf Typ.3us at $V_{CE} = 2\text{V}$, $I_C = 2\text{mA}$, $R_L = 100\Omega$)
- 工作温度可达+110°C Operating temperature up to +110°C
- 4PIN引脚封装模式
4PIN DIP encapsulation mode
- 无Pb且符合ROHS标准 Pb free and RoHS compliant
- 静电放电:人体模式8000V、机器模式2000V
ESD pass HBM 8000V/MM2000V
- 安全审批 Safety approval
CQC认证已批准(编号:CQC23001407997) CQC approved (No. CQC23001407997)
UL认证已批准 (编号:UL-CA-2340753-0) UL approved (No: UL-CA-2340753-0)

2. 产品描述 Product Description

- KL816光耦合器由一块砷化镓发射器和一块NPN晶体管组成
KL816 photo coupler consist of one piece of GaAs emitter and one piece of NPN
- 它们采用4引脚DIP封装, 并提供宽引线间距和SMD选项
Packaged in a 4-pin DIP package and available in wide-lead spacing and SMD option

3. 产品应用 Product Applications

- 电流表、计算机 Ammeter、Computer
- 开关电源 Switching power supply
- 仪器应用、测量仪器 Instrumental application、measuring instruments
- 家用电器, 如风扇加热器等 Home appliances, such as fan heaters, etc.
- 电信设备 Telecommunication equipments
- 复印机、自动化设备 Copiers, automation equipment

4. 功能图 Functional Diagram

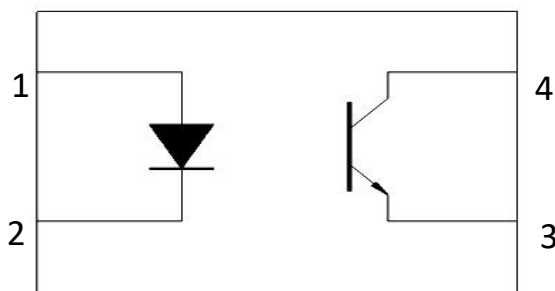

引脚配置 Pin Configuration

1. 阳极Anode
2. 阴极Cathode
3. 发射极Emitter
4. 集电极Collector

5. 光电特性 Electrical-Optical characteristics

• 最大限度额定值(温度=25°C) Absolute Maximum Ratings(Ta=25°C)

参数 Parameter		符号 Symbol	额定值 Rated Value	单位 Unit
输入 Input	正向电流 Forward current	I_F	60	mA
	峰值正向电流(100us脉冲,100Hz频率) Peak forward current (100us pulse,100Hz frequency)	I_{FP}	1	A
	反向电压 Reverse voltage	V_R	6	V
	输入功率 Input Power	P_D	100	mW
输出 Output	集电极电流 Collector current	I_C	50	mA
	集电极与发射极间电压 Collector and emitter Voltage	V_{CEO}	80	V
	发射极与集电极间电压 Emitter and Collector Voltage	V_{ECO}	6	V
	输出功率 Output Power	P_C	150	mW
总消耗功率 Total Consume Power		P_{TOT}	200	mW
隔离电压 (1*)Isolation Voltage		V_{iso}	5000	Vrms
工作温度 Operating temperature		T_{OPR}	-55 to +110	°C
储存温度 Storage temperature		T_{STG}	-55 to +125	°C
焊接温度 (2*) Soldering temperature		T_{SOL}	260	°C

附注(Notes):

1* 交流电源1分钟内, 相对湿度40~60%环境下, 隔离电压测试方法, 1&2脚短接在一起, 3&4脚短接在一起

AC for 1 minute, 40~60%RH in this test, Pin 1,2 are shorted together, and 3,4 are shorted together

2* 焊接时间为10秒 Soldering time is 10 seconds

6. 电气特性(Ta=25°C,除非另有规定)

Electrical Characteristics(Ta=25°C unless specified otherwise)

参数 Parameter		符号 Symbol	最小值 Min.	规格值 Typ.	最大值 Max.	单位 Unit	条件 Condition
输入 In put	正向电压 Forward voltage	V_F	-	1.2	1.4	V	$I_F=20\text{mA}$
	反向电流 Reverse current	I_R	-	-	10	μA	$V_R=4\text{V}$
	输入电容 Input capacitance	C_{in}	-	30	250	pF	$V=0, f=1\text{kHz}$
输出 Out put	集电极与发射极间暗电流 Collector-Emitter dark current	I_{CEO}	-	-	100	nA	$V_{CE}=20\text{V}$ $I_F=0\text{mA}$
	集电极与发射极间击穿电压 Collector-Emitter breakdown voltage	V_{CEO}	80	-	-	V	$I_C=0.1\text{mA}$ $I_F=0\text{mA}$
	发射极与集电极间击穿电压 Emitter-Collector breakdown voltage	V_{ECO}	6	-	-	V	$I_E=0.1\text{mA}$ $I_F=0\text{mA}$
传输特性 Transfer Characteristics	集电极与发射极间饱和电压 Collector-Emitter saturation voltage	$V_{CE(sat)}$	-	0.1	0.2	V	$I_F=20\text{mA}$ $I_C=1\text{mA}$
	电流传输比 Current transfer ratio(1*)	CTR	50	-	600	%	$I_F=5\text{mA}$ $V_{CE}=5\text{V}$
	集电极电流 Collector Current	I_C	2.5	-	30	mA	$I_F=5\text{mA}$ $V_{CE}=5\text{V}$
	隔离电阻 Isolation resistance	R_{ISO}	5×10^{10}	1×10^{12}	-	Ω	$V_{IO}=500\text{Vdc}$ 40~60% R.H.
	浮动电容 Floating capacitance	C_f	-	0.6	1.0	pF	$V_{IO}=0, f=1\text{MHz}$
	截止频率 Cut-off frequency	f_c	-	80	-	kHz	$V_{CE}=5\text{V}$, $I_C=2\text{mA}$ $R_L=100, -3\text{dB}$
	上升时间 Rise time	t_r	-	4	18	μs	$V_{CE}=2\text{V}$, $I_C=2\text{mA}$, $R_L=100\Omega$
下降时间 Fall time	t_f	-	3	18	μs		

1* 当前转换比率= $I_C/I_F \times 100\%$, CTR公差: $\pm 3\%$ Current Conversion Ratio = $I_C / I_F \times 100\%$, CTR Tolerance: $\pm 3\%$.

- 传输特性等级表(Ta=25°C, 除非另有规定)

Transfer Characteristics level table (Ta=25°C unless specified otherwise)

参数 Parameter		符号 Symbol	最小值 Min.	规格值 Typ.*	最大值 Max.	单位 Unit	条件 Condition
电流传输比 Current Transferratio	KL816	CTR	50	-	600	%	I _F =5mA V _{CE} =5V
	KL816A		80	-	160		
	KL816B		130	-	260		
	KL816C		200	-	400		
	KL816D		300	-	600		
	KL816X		100	-	200		
	KL816Y		150	-	300		
	KL816I	CTR	63	-	125	%	I _F =10mA V _{CE} =5V
	KL816J		100	-	200		
	KL816K		160	-	320		
	KL816I		22	-	-		I _F =1mA V _{CE} =5V
	KL816J		34	-	-		
	KL816K		56	-	-		

7. 可靠性试验 Reliability Test

序号 NO.	试验项目 Test Items	参考标准 Reference	试验条件 Test conditions	试验过程 Test process	试验数 Qty.(pcs)	允收水准 LTPD
1	温度循环 TC	JESD22-A104C	H:125±5°C 15min J5min L:-55±5°C 15min	300cycle	45	0/45
2	高温操作寿命 HTOL	JESD22-A108C	HTOL@110±5°C I _F =10mA I _C =10mA	168、500、 1000hrs	45	0/45
3	高温反向偏压 HTRB	JESD22-A108C	HTRB@125±5°C V _{ce} =60V	168、500、 1000hrs	45	0/45
4	温湿度反向偏 压寿命试验 H3TRB	JESD22-A101- B	H3TRB@ 85±5°C、 85±5%RH V _{ce} =60V	168、500、 1000hrs	45	0/45
5	压力锅 Autoclave	JESD22-A102- C	T _a =121±5°C, 100±5%RH, 2atm	96hrs	45	0/45
6	高温储存 HTS	JESD22-A103C	HTS@125±5°C	168、500、 1000hrs	45	0/45
7	低温储存 LTS	JESD22-A119	LTS@-55±5°C	168、500、 1000hrs	45	0/45
8	耐锡热试验 RSH	JESD22-B106C	RSH@260±5°C	10sec*3times	45	0/45
9	可焊性 SD	JESD22-B102D	Pb-free@ 245±5°C	3sec*1times	22	0/22
备注 Remarks	以上试验项目如与客户试验要求存在差异或者特殊客户特殊要求的,可根据实际情况按照客户的要求进行试 作,客户未要求依我司试验标准试作,不同产品使用不同电流进行测试 All the tests should be performed according to customers' actual requirements, while difference of test standard or special requirements exist. Otherwise, all the tests are performed according to the standard listed above. Different current is applied to the tests of different product models					

8. 特性曲线 Characteristic Curves

图1. 正向电流与环境温度关系

Forward current vs Ambient temperature



图2. 正向电流与正向电压的关系

Figure1. Forward Current VS Forward Voltage



图3. 电流传输比与正向电流

Current Transfer Ratio vs Forward Current

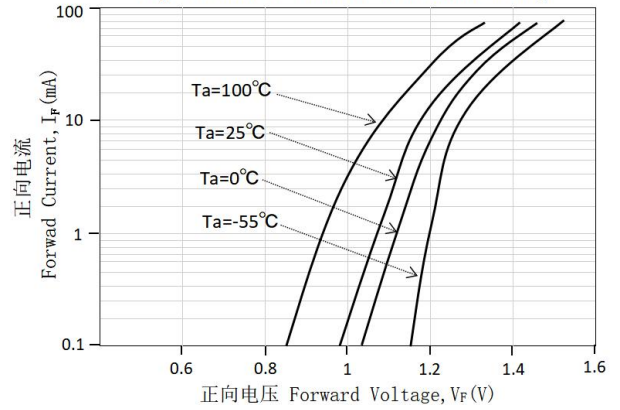

图4. 集电极电流与集电极-发射极电压

Collector Current vs Collector-Emitter Voltage

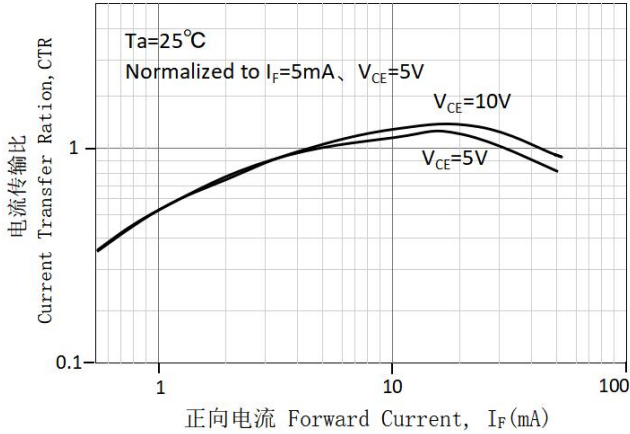

图5. 集电极电流与环境温度关系

Collector Current vs Ambient Temperature

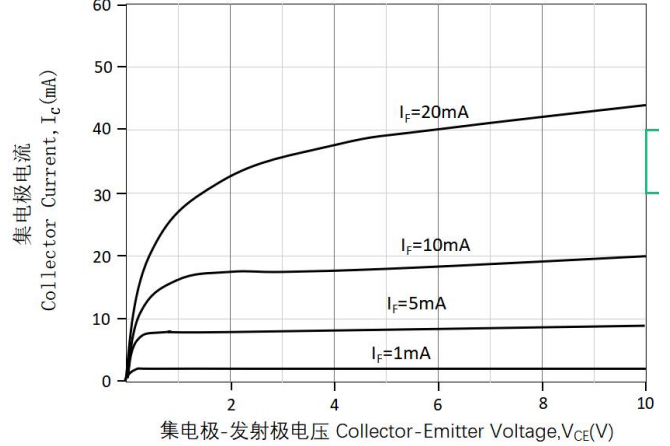

图6. 集电极暗电流与环境温度的关系

Collector Dark Current vs Ambient Temperature



图7. 集电极-发射极饱和电压与环境温度关系
Collector-Emitter Saturation Voltage vs Ambient Temperature



图8. 开关时间与负载电阻的关系
Switching Time vs Load Resistance

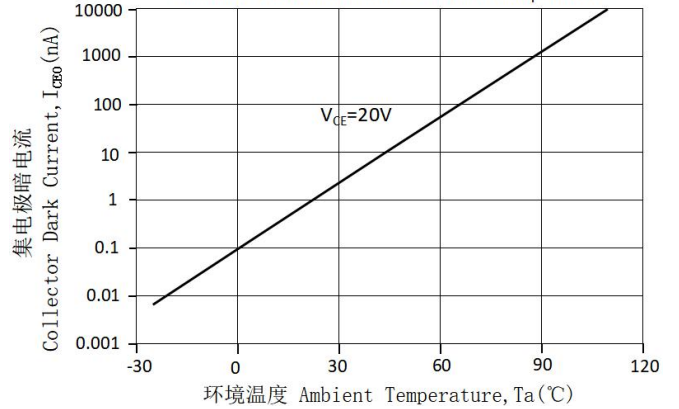

图9. 开关时间测试电路与波形
Switching Time Test Circuit vs Waveforms

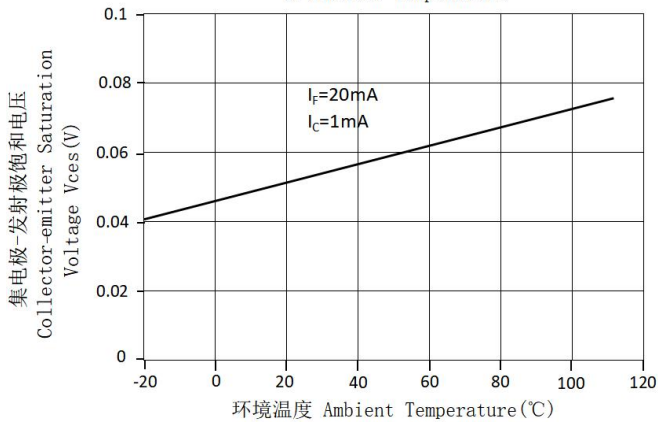

9. 订单信息 Order Information

- 零件编号 Part Number

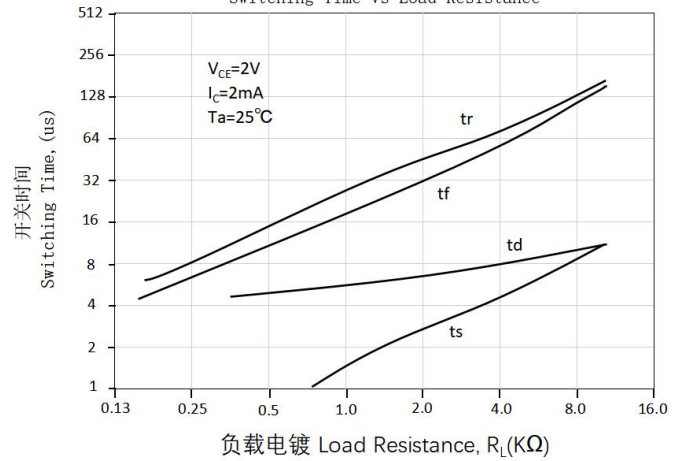
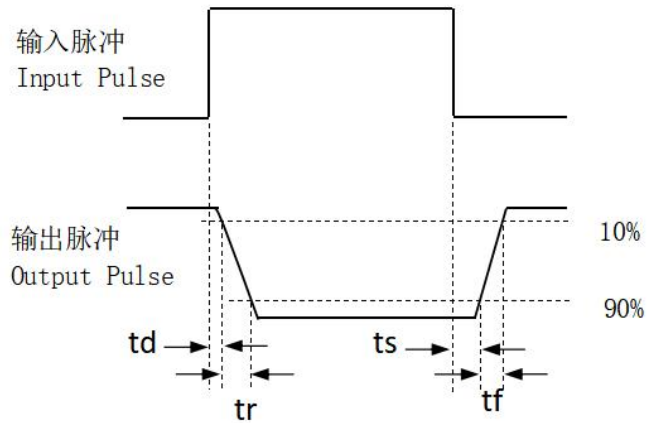
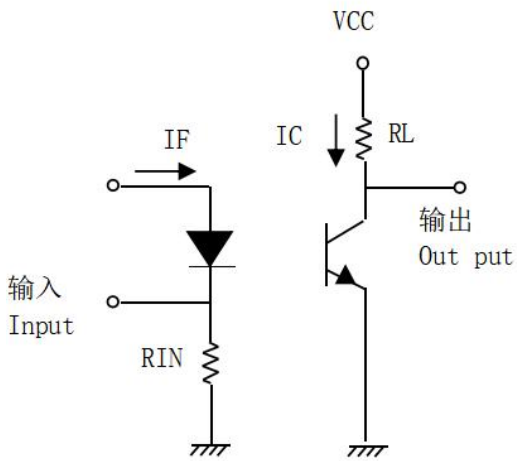
KL816X(Y)(Z)-V

(料号PN:KL816X-Y-Z-V)

附注(Notes):

- X = 表示引脚形式选项(S、S1、S2、M 或 无) Lead form option (S, S1, S2, M or none)
 Y = 表示CTR等级(A、B、C、D、X、Y、I、J、K 或 无) CTR Rank (A, B, C, D, X, Y, I, J, K or none)
 Z = 表示料带和卷盘选项(TA、TB、TU、TD 或 无) Tape and reel option (TA, TB, TU, TD or none)
 V = 表示VDE标识(客户指定镭射字符才加"V")
 VDE (Only add "V" to laser characters specified by the customer)

选项 Option	描述 Description	包装数量 Packing quantity
直脚None	标准DIP-4 Standard DIP-4	每管100pcs 100 units per tube
M	折弯脚(0.4英寸间距) Wide lead bend (0.4 inch spacing)	每管100pcs 100 units per tube
S (TA)	表面贴装脚型方式+ TA料带 & 卷轴选择 Surface mount lead form + TA tape & reel option	每卷1000pcs 1000 units per reel
S (TB)	表面贴装脚型方式+ TB料带 & 卷轴选择 Surface mount lead form + TB tape & reel option	每卷1000pcs 1000 units per reel
S1 (TA)	表面贴装脚型方式(低轮廓)+ TA料带 & 卷轴选择 Surface mount lead form (low profile) + TA tape & reel option	每卷1000pcs 1000 units per reel
S1 (TB)	表面贴装脚型方式(低轮廓)+ TB料带 & 卷轴选择 Surface mount lead form (low profile) + TB tape & reel option	每卷1000pcs 1000 units per reel
S2 (TA)	表面贴装脚型方式(翅形)+ TA料带 & 卷轴选择 Surface mount lead form (Gull-wing) + TA tape & reel option	每卷1000pcs 1000 units per reel
S2 (TB)	表面贴装脚型方式(翅形)+ TB料带 & 卷轴选择 Surface mount lead form (Gull-wing) + TB tape & reel option	每卷1000pcs 1000 units per reel
S (TU)	表面贴装脚型方式+ TU料带 & 卷轴选择 Surface mount lead form + TU tape & reel option	每卷1500pcs 1500 units per reel
S (TD)	表面贴装脚型方式+ TD料带 & 卷轴选择 Surface mount lead form + TD tape & reel option	每卷1500pcs 1500 units per reel
S1 (TU)	表面贴装脚型方式(低轮廓)+ TU料带 & 卷轴选择 Surface mount lead form (low profile) + TU tape & reel option	每卷1500pcs 1500 units per reel
S1 (TD)	表面贴装脚型方式(低轮廓)+ TD料带 & 卷轴选择 Surface mount lead form (low profile) + TD tape & reel option	每卷1500pcs 1500 units per reel

10. 封装尺寸(单位:毫米) Package Drawing(Unit:mm)

- 标准DIP型号 Standard DIP Type



- 选择M型号 Option M Type

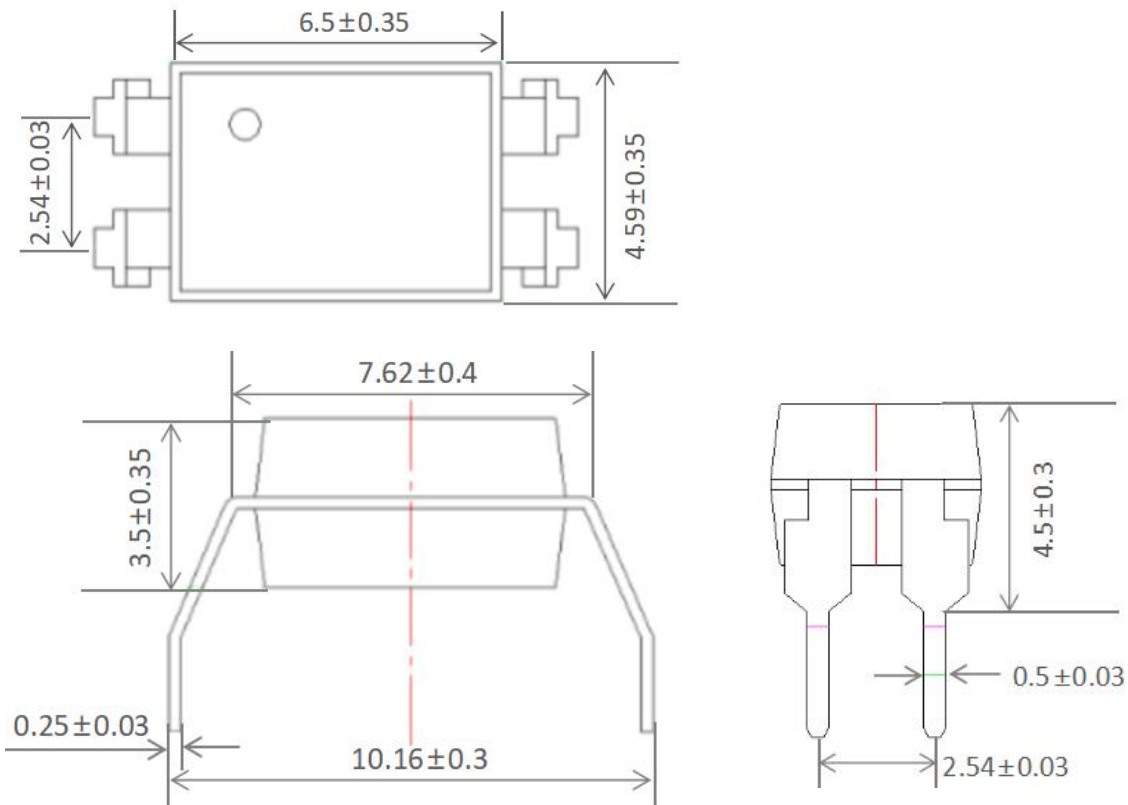

• 选择S型号 Option S Type



• 选择S1型号 Option S1 Type

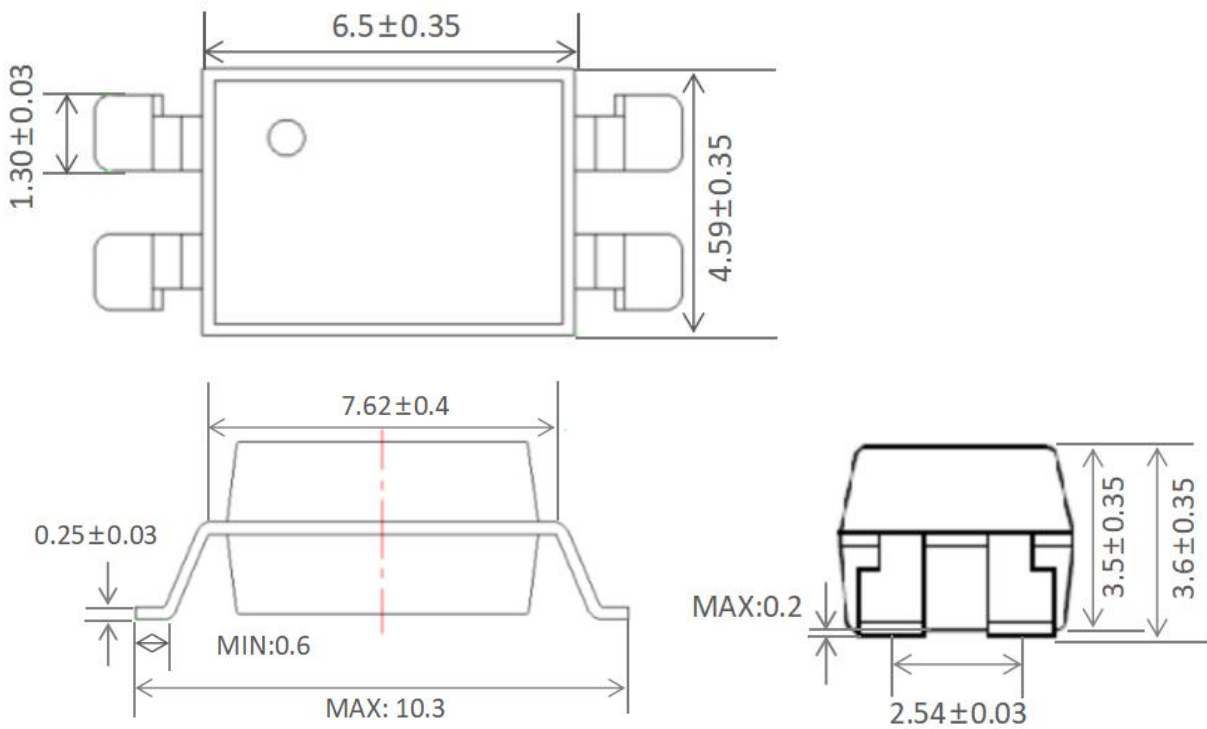

• 选项S2型号 Option S2 Type

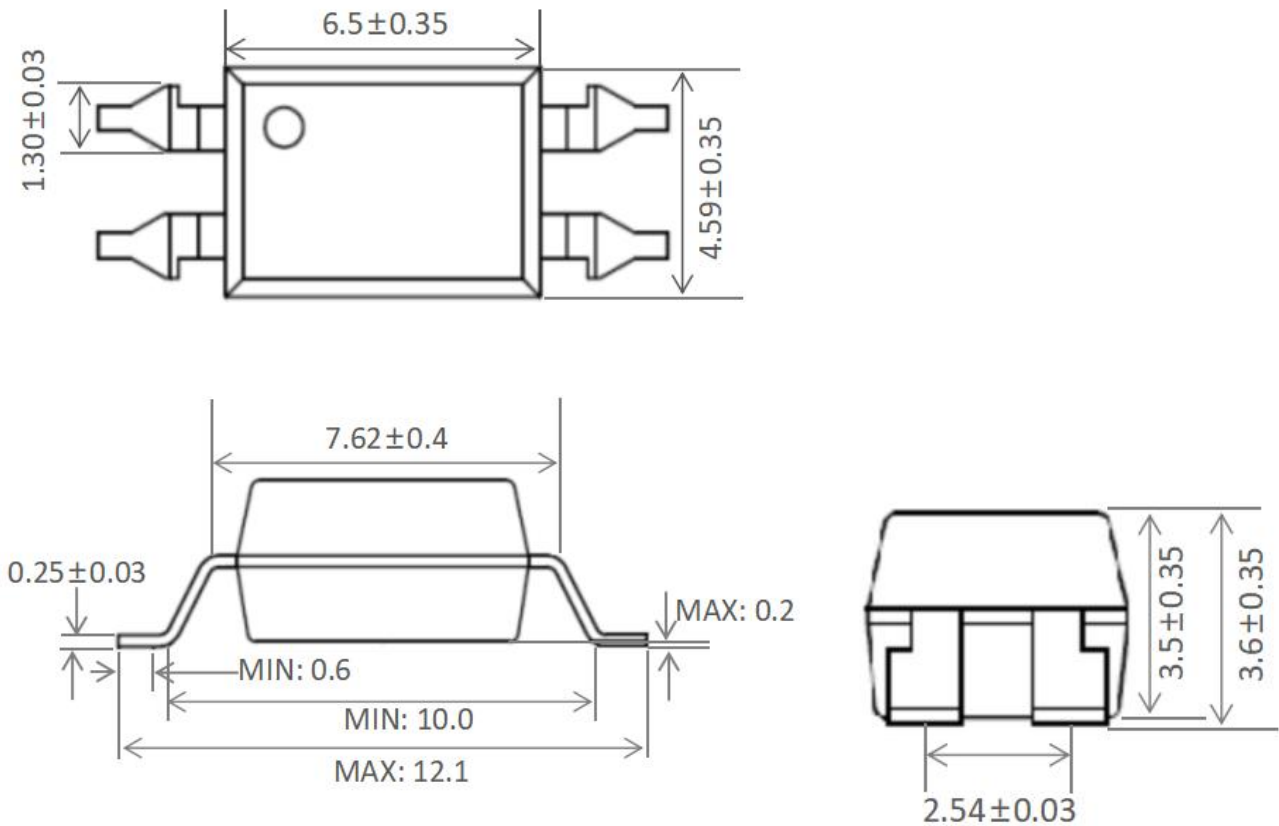

• 表面贴装引线框架 推荐焊盘布局 Recommended pad layout for surface mount leadform

S和S1脚型选项 The S and S1 foot-type

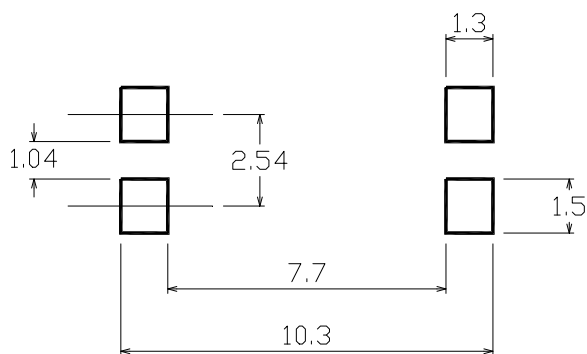

S2脚型选项 The S2 foot-type options

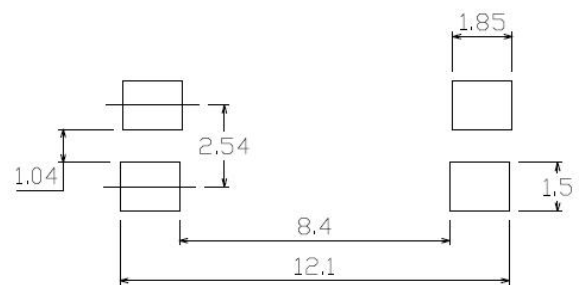

附注(Notes):

- 建议焊盘尺寸仅供参考 Suggested pad dimension is just for reference only
- 请根据个人需要修改焊盘尺寸 Please modify the pad dimension based on individual need

11. 设备标记 Device marking

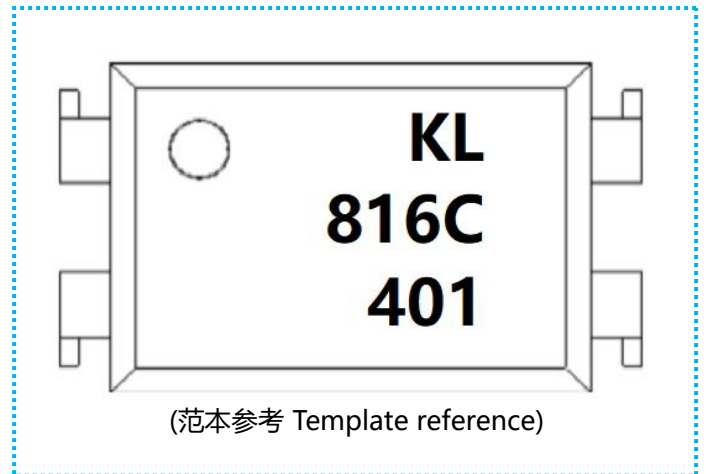
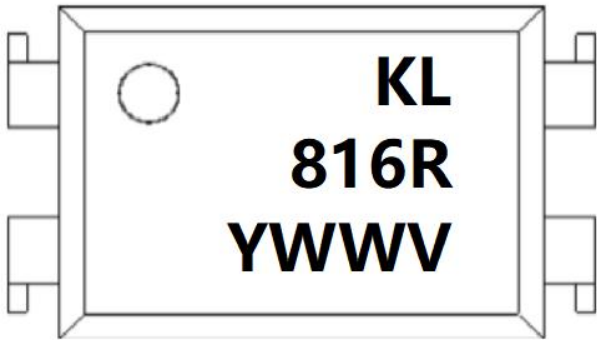

(范本参考 Template reference)

附注(Notes):

- KL = 表示晶台光电有限公司
denotes KingLight
- 816 = 表示材料部件号
denotes Device Part Number
- R = 表示CTR等级
denotes CTR Rank
- Y = 表示1位年份代码
denotes 1 digit Year code
- WW = 表示2位周别代码
denotes 2 digit Week code
- V = 表示VDE标识(客户指定镭射字符才加"V")
VDE (Only add "V" to laser characters specified by the customer)

12. 料带和卷轴包装规格 Tape & Reel Packing Specifications

• 选择TA Option TA

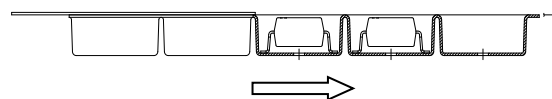
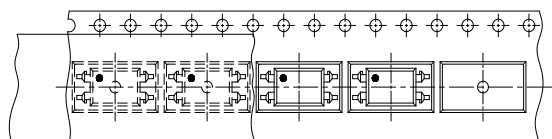

卷轴进给方向 Direction of feed from reel

• 选择TB Option TB

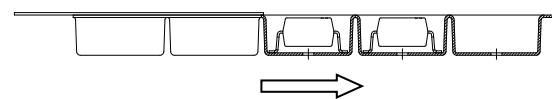
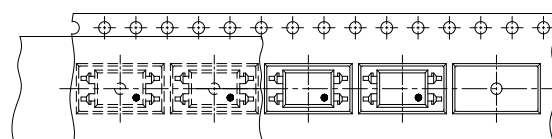

卷轴进给方向 Direction of feed from reel

料带尺寸 Material belt size

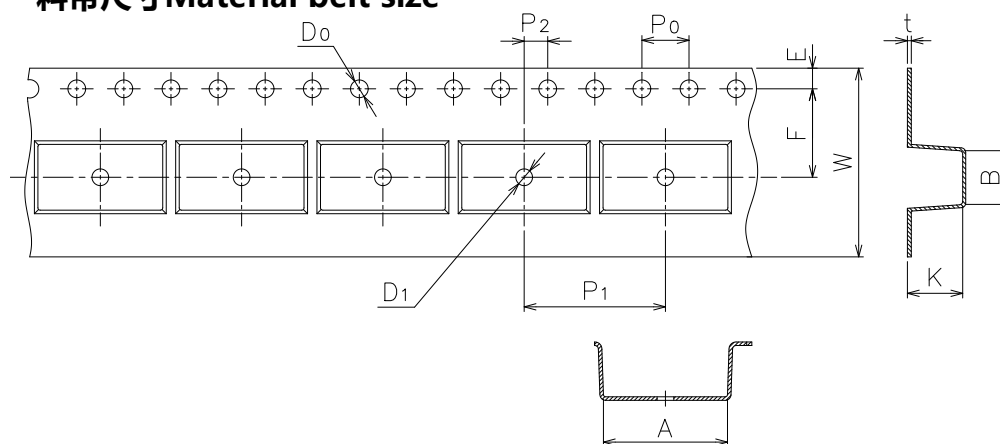

尺寸编号 Dimension No.	A	B	D0	D1	E	F
尺寸(mm) Dimension(mm)	10.4±0.1	4.55±0.1	1.5±0.1	1.5±0.1	1.75±0.1	7.5±0.1
尺寸编号 Dimension No.	P0	P1	P2	t	W	K
尺寸(mm) Dimension(mm)	4.0±0.1	12.0±0.1	2.0±0.1	0.33±0.1	16.0+0.3/-0.1	4.55±0.1

• 选择TD Option TD

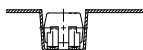
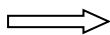
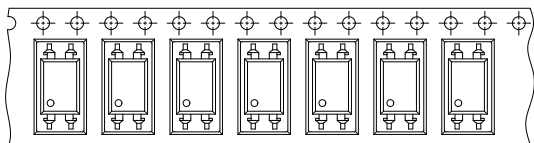

卷轴进给方向 Direction of feed from reel

• 选择TU Option TU

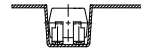
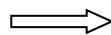
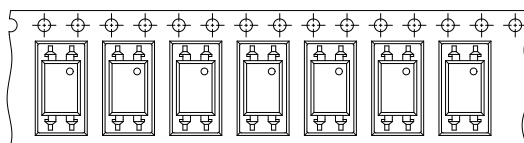

卷轴进给方向 Direction of feed from reel

料带尺寸 Material belt size

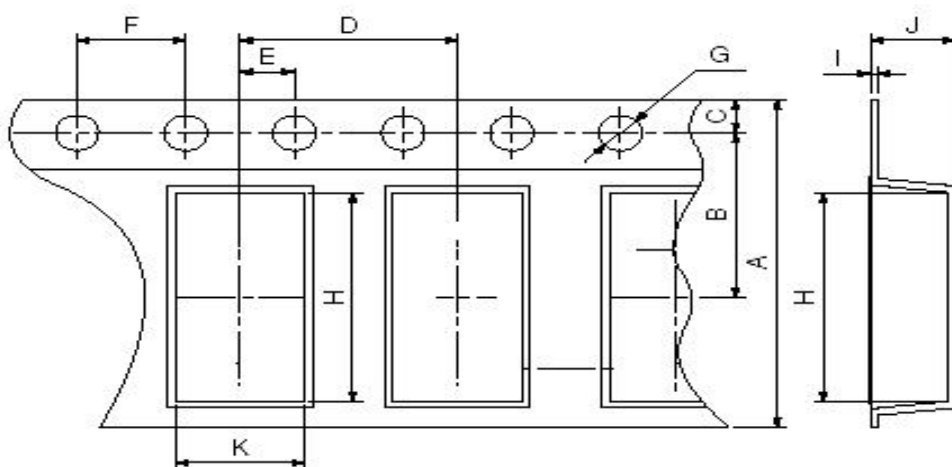

尺寸编号 Dimension No.	A	B	C	D1	E	F
尺寸(mm) Dimension(mm)	16±0.3	7.5±0.1	1.75±0.1	8.0±0.1	2.0±0.1	4.0±0.1
尺寸编号 Dimension No.	G	H	I	J	K	
尺寸(mm) Dimension(mm)	1.5+0.1/-0	10.4±0.1	0.4±0.05	4.55±0.1	5.1±0.1	

13. 焊接温度曲线 Temperature Profile Of Soldering

• 回流焊温度曲线 Reflow soldering

建议在下面所示的温度和时间分布条件下, 进行一次回流焊作业, 不得超过三次

One time soldering reflow is recommended within the condition of temperature and time profile shown below. Do not solder more than three times.

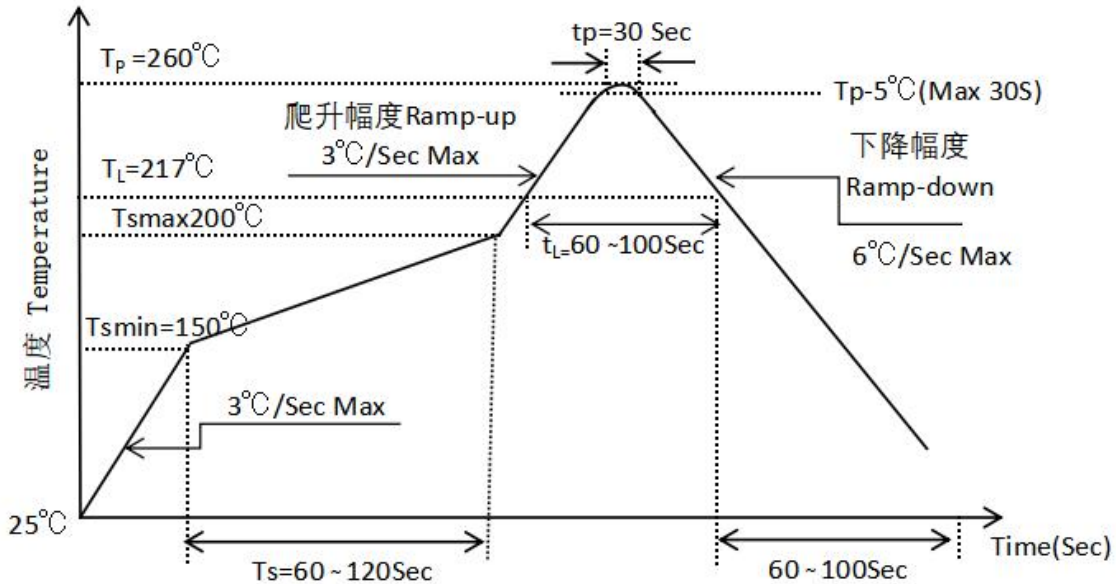

项目 Item	符号 Symbol	最小值 Min.	最大值 Max.	单位 Unit
预热温度 Preheat Temperature	T_s	150	200	°C
预热时间 Preheat Time	t_s	60	120	s
升温速率 Ramp-Up Rate (T_L to T_p)	-	-	3	°C/s
液相线温度 Liquidus Temperature	T_L	217		°C
高于液相线温度(T_L)的时间 Time above Liquidus Temperature T_L	t_L	60	100	s
峰值温度 Peak Temperature	T_p	-	260	°C
T_c 在(T_p-5)和 T_p 之间的时间 Time During Which T_c Is Between (T_p-5) and T_p	t_p	-	30	s
降温速率 Ramp-down Rate(T_p to T_L)	-	-	6	°C/s

• 波峰焊温度曲线 Wave Soldering

温度条件下, 建议一次焊接

One time soldering is recommended within the condition of temperature

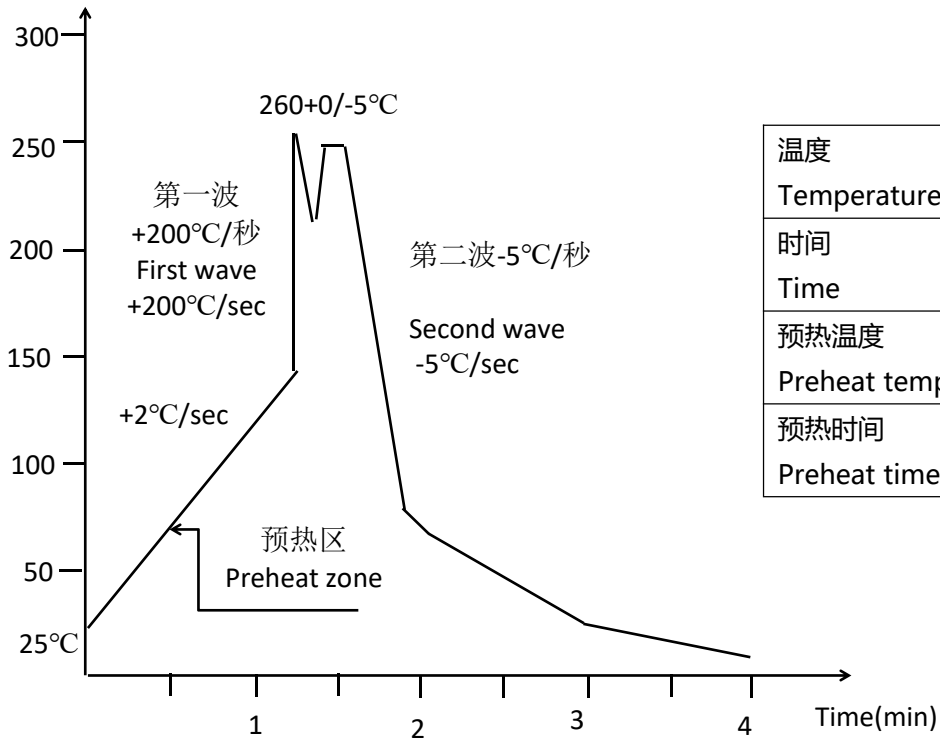

X-ON Electronics

Largest Supplier of Electrical and Electronic Components

Click to view similar products for [Transistor Output Optocouplers](#) category:

Click to view products by [Kinglight](#) manufacturer:

Other Similar products are found below :

[LTV-814S-TA](#) [LTV-852S](#) [66095-001](#) [PS2561-1-A](#) [PS2561A-1-W-A](#) [PS2561L1-1-A](#) [PS2561L-1-V-A](#) [PS2706-1-A](#) [PS2815-1-A](#) [MRF658](#)
[ELD207\(TA\)](#) [ILD2-X006](#) [ILQ615-3X016](#) [LDA102S](#) [SFH615A-4XSM TR](#) [PS2561DL-1Y-F3-A](#) [PS2561L1-1-L-A](#) [PS2562-1-V-A](#) [PS2565L-](#)
[1-A](#) [PS2581L2-A](#) [PS2701A-1-F3-P-A](#) [PS2711-1-A](#) [PS2801-1-F3-P-A](#) [PS2833-4-A](#) [PS2841-4A-AX](#) [LTV-702FS](#) [LTV-702V](#) [LTV-702VB](#)
[LTV-816S-TA](#) [TCET2100](#) [TLP290-4\(E\(T](#) [IL215AT](#) [WPPC-A11066AA](#) [WPPC-A11066AD](#) [WPPC-A11084ASS](#) [WPPC-A21068AA](#) [WPPC-](#)
[D11066AA](#) [WPPC-D21068ED](#) [WPPC-D410616EA](#) [WPPC-D410616ED](#) [X4IAC24A](#) [4N26-X001](#) [EL1010\(TA\)-VG](#) [SFH600-2X007](#)
[TCMT1118](#) [VO206AT](#) [WPPC-D21068EA](#) [WPPC-D11064AD](#) [WPPC-A410616AD](#) [WPPC-A21068AD](#)