

# SPECIFICATION FOR APPROVAL

## 承 認 書

Description : Micro Dynamic Speaker

Kingstate Part No. : KDMG28008-05WA

Customer's Model No. : \_\_\_\_\_

Specification No. : PKD-9495

Number Of The Edition : 1.2

CUSTOMER'S APPROVED SIGNATURE		

志豐電子股份有限公司 KINGSTATE ELECTRONICS CORP.





Address :10F, No. 69-11, Sec. 2, Chung Cheng E. Rd., Tamshui County, Taipei Hsien, Taiwan, R.O.C.

International sales dept.: TEL:886-2-2809-5651 FAX:886-2-2809-7151

Domestic sales dept.: TEL:886-2-2809-0668 FAX:886-2-28096748

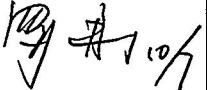
<http://www.kingstate.com.tw>

Approved by	Checked by	Issued by
	 2022.10.17	陽志明 2022.10.07

## A. SCOPE 範疇

This specification applies speaker, **KDMG28008-05WA**

此規格書適用於喇叭, **KDMG28008-05WA**

## B. SPECIFICATION 規格

No.	Item	Symbol	Unit	Specification	Condition
1	Dimension 尺寸		mm	$\varphi$ 28.0 x 4.6	
2	Power Rating 功率		W	Rated. 0.5/ MAX. 1.0	Maximum Power:IEC-60268-5 Filter 60s On/120s Off 10 Cycles (Room TEMP.)
3	Impedance 阻抗	$\Omega$	ohm	$8 \pm 15\%$	At 1.0kHz 1.0V
4	Resonance Frequency 低音諧振	Fo	Hz	$700 \pm 20\%$	At ,1.0V
5	Output S.P.L. 音壓位準		dB	$95 \pm 3\text{dB}(0.5\text{w}/10\text{cm})$ $79 \pm 3\text{dB}(1\text{w}/1\text{m})$	At 1.0k,1.2k,1.5k,2.0kHz (Average figures)
6	Frequency Rang 有效頻寬		Hz	Fo---6.0K	Output S.P.L. $\pm 10\text{dB}$
7	Distortion 失真		%	10% Max.	At 1.0kHz , 0.5W
8	Voice Coil 音圈		mm		
9	Magnet 磁石		mm		Nd-Fe-B(鈹鐵鏷)
10	Flux Density 磁通密度		Gauss		Min.
11	Operating temp. 操作溫度		$^{\circ}\text{C}$	-20~+55	
12	Storage Temperature 儲存溫度		$^{\circ}\text{C}$	-20~+60	
13	Operating Humidity 操作濕度		%	20%~80%	
14	Storage Humidity 儲存濕度		%	20%~80%	
15	Buzzer & Rattle 異常音				Not be audible at 2.0V sine wave between Fo ~ 6.0KHz 輸入 2.0V 正弦波從 Fo 到 6.0KHz 之間無異常音.
16	Weight 重量		g	5.4	
17	Material 材質			Metal	
18	Environmental Protection Regulation 環保法規			RoHS 2.0	

### C. TYPICAL FREQUENCY RESPONSE CURVE 頻率響應曲線

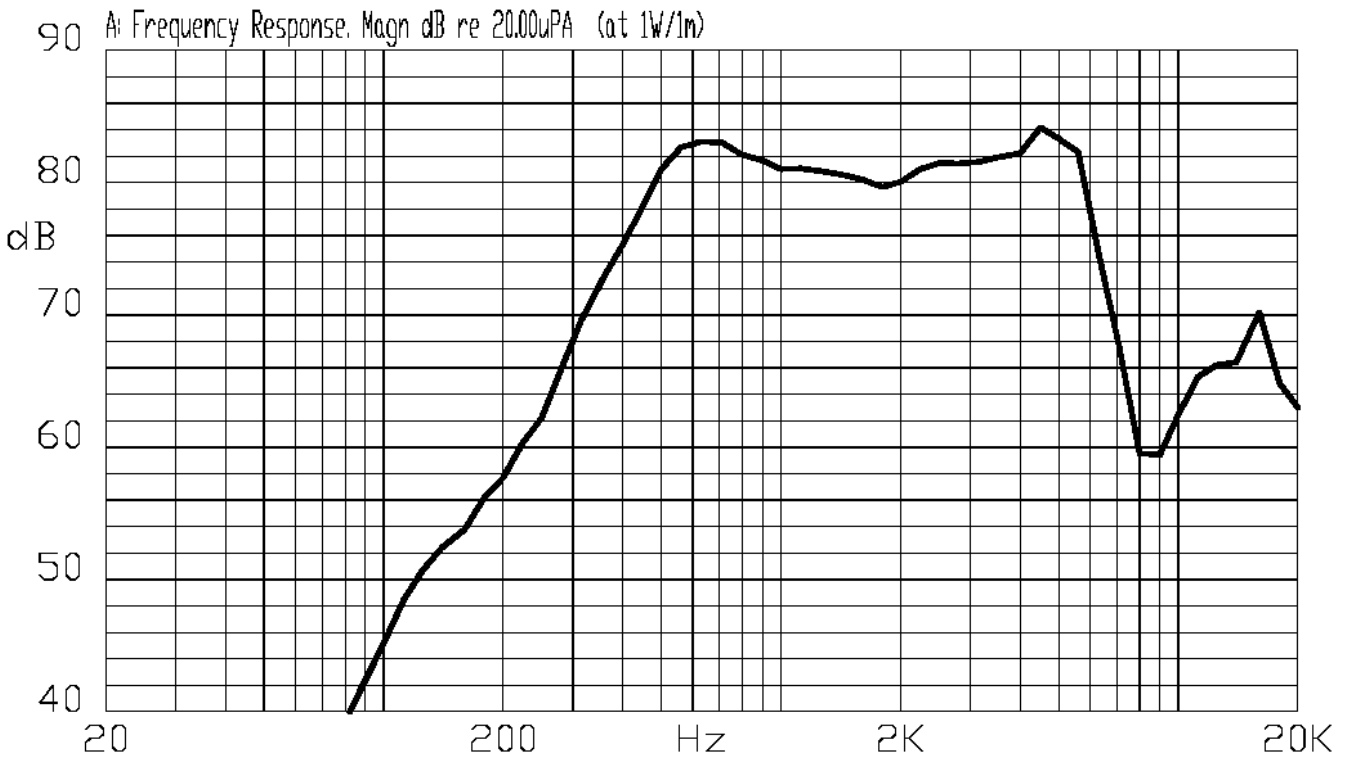
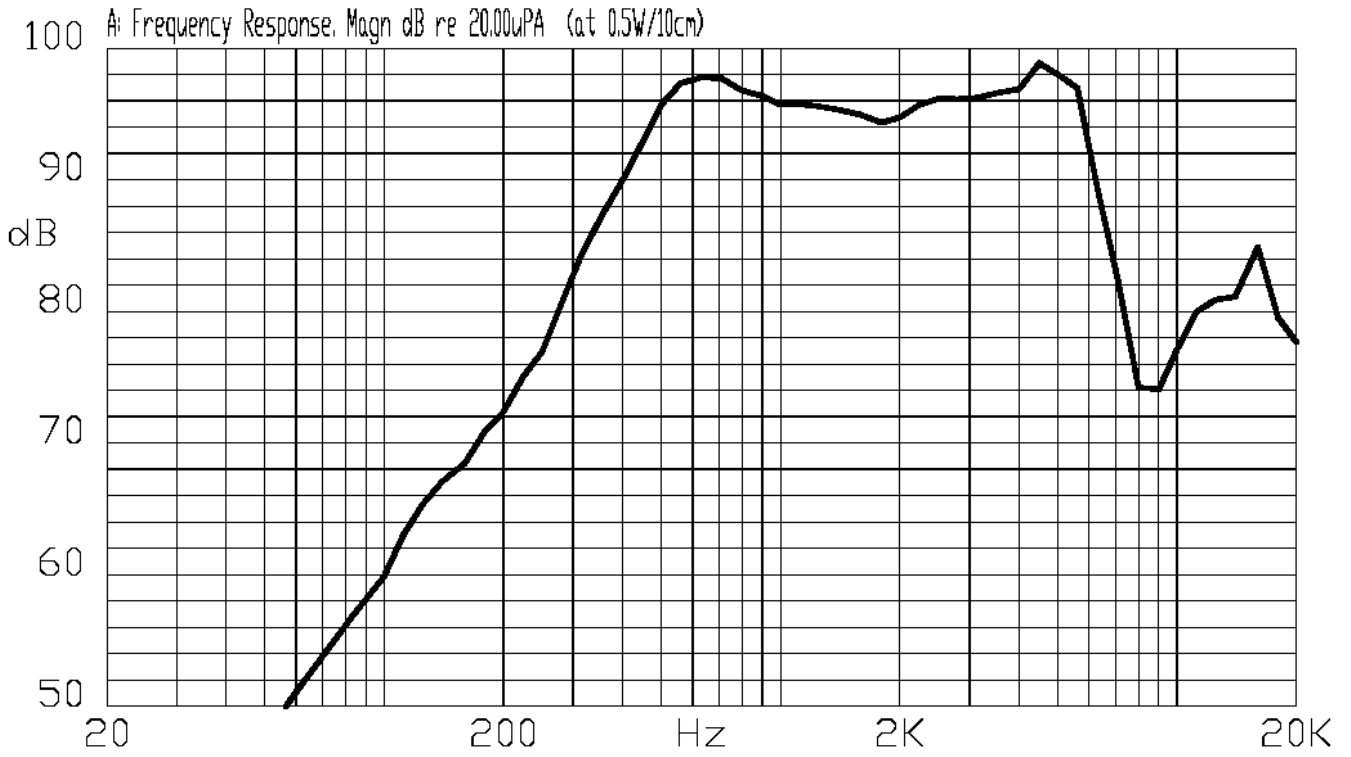

## D. APPEARANCE DRAWING 外觀尺寸圖

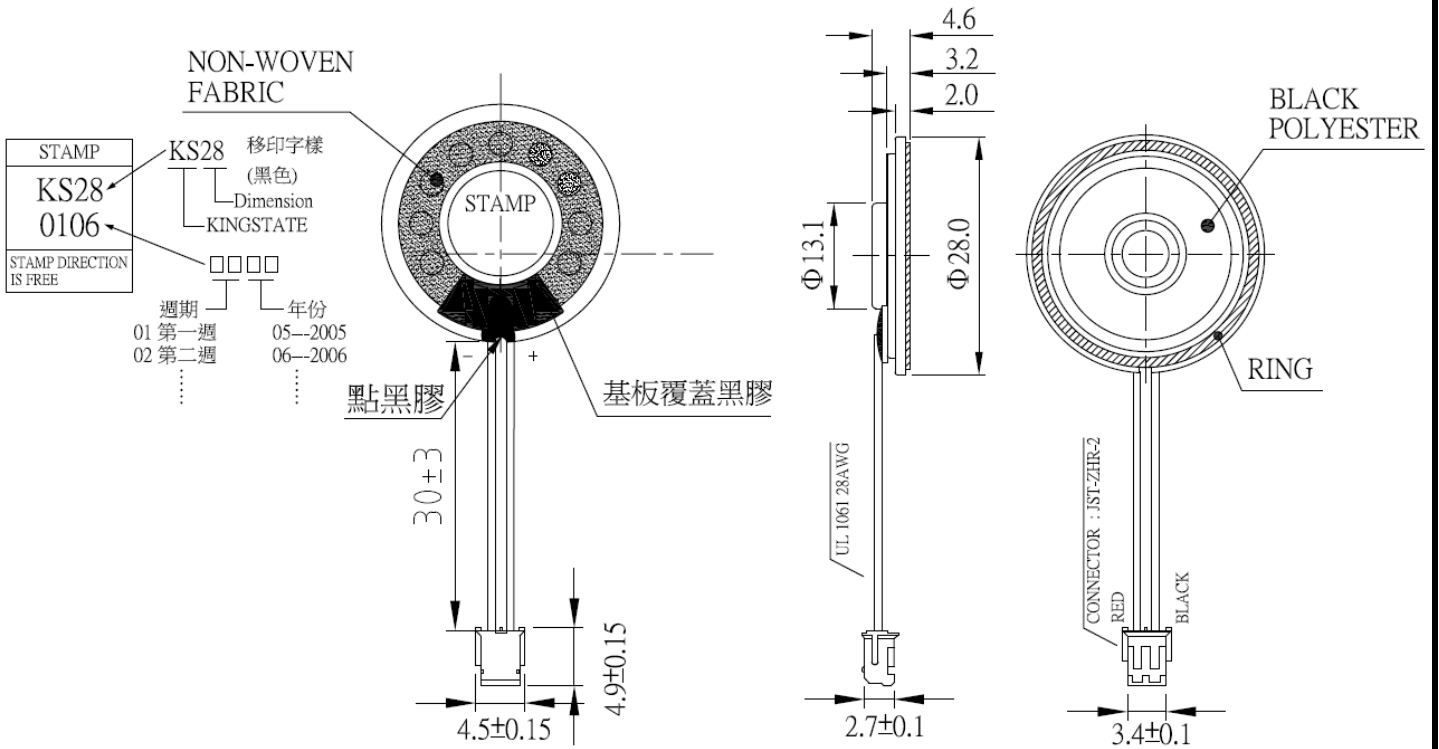

Tol: ± 0.3

Unit: mm

## E. MEASUREMENT CIRCUIT 測量線路

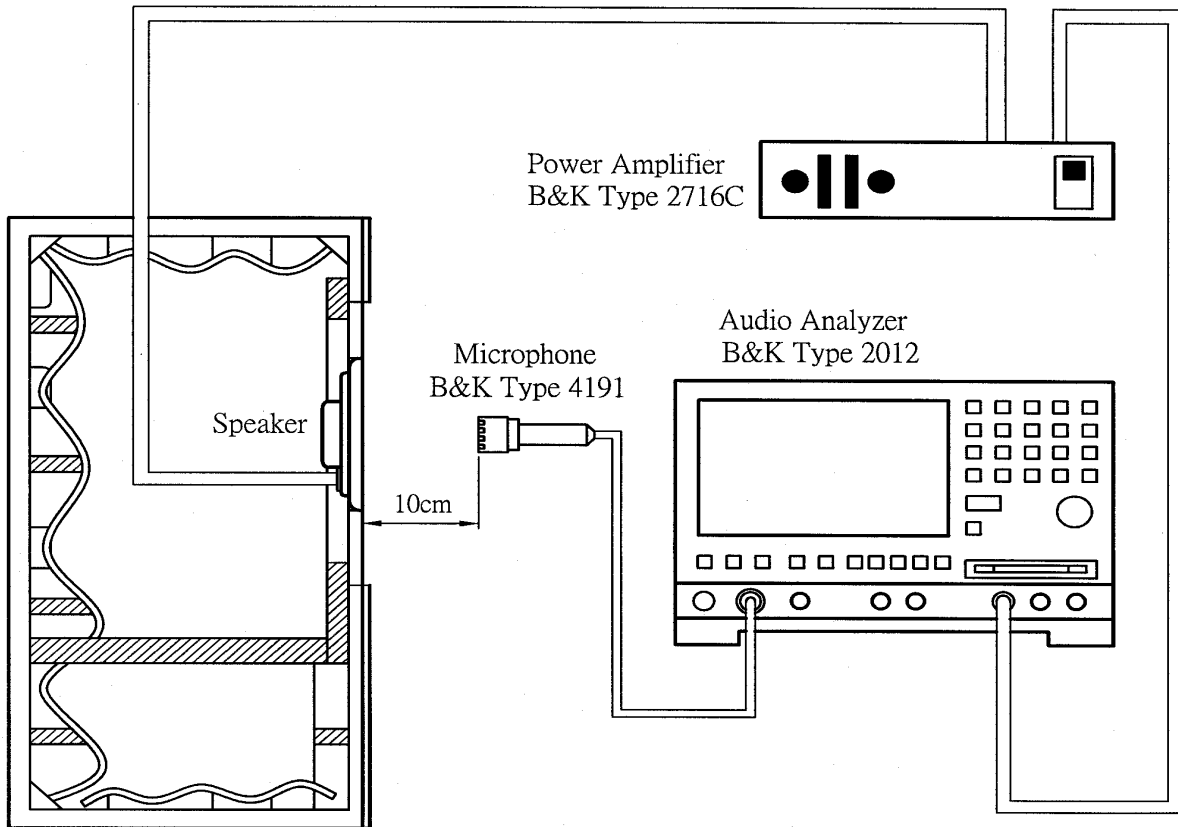

JIS C5531

940mm x 640mm x 1240mm

## F. MECHANICAL CHARACTERISTICS 機械特性

No.	Item	Test condition	Evaluation standard
1	PCB Wire Pull Strength PCB 線材拉力	The pull force shall be applied to double lead wire : Horizontal 3.0N(0.306kg) for 30 seconds. 雙線材水平方向施以 3.0N(0.306kg)的力量, 30 秒.	No damage and cutting off 不鬆動, 不脫落.
2	Vibration Test 振動測試	Speaker shall be measured after being applied vibration of amplitude of 1.5mm with 10 to 55Hz band of vibration frequency to each of 3 perpendicular directions for 2 hours. 振動週波數 10~55Hz、全振幅 1.5mm 於 X.Y.Z 3 個方向, 各 2 小時.	No obstacle to be harmful to normal operation; damages, cracks, rusts and distortions. Should not be audible at 2.0V sine wave between Fo ~ 6.0KHz
3	Drop Test 落下測試	Drop the speakers contained in normal box onto the board 40mm thick 10 times from the height of 75cm. 將揚聲器置於盒中, 自 75 公分高度落在 40mm 木板上共 10 次.	測試後無任何障礙防礙正常操作. 且在輸入 2.0V 正弦波從 Fo 到 6.0KHz 之間無異常音.

## G. ENVIRONMENTAL TEST 環境試驗

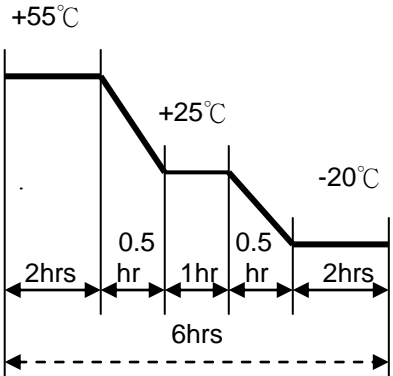
No.	Item	Test conditions	Evaluation standard
1	High temp. Test 高溫測試	After being placed in a chamber at +55°C for 96 hours 置於+55°C環境中 96 小時	Being placed for 6 hours at +25°C, speaker shall be measured. No obstacle to be harmful to normal operation; damages, cracks, rusts, etc. Should not be audible at 2.0V sine wave between Fo ~ 6.0KHz. Fo should meet initial one. S.P.L. deviation of unit should be within ±3dB 經測試後, 靜置於+25°C (室溫)環境中 6 小時後, 測試後無任何障礙防礙正常操作. 且在輸入 2.0V 正弦波從 Fo 到 6.0KHz 之間無異常音. Fo 與原規格值相同, 輸出音壓變化量在±3dB 內.
2	Low temp. Test 低溫測試	After being placed in a chamber at -20°C for 96 hours. 置於-20°C環境中 96 小時	
3	Humidity test 相對濕度測試	After being placed in a chamber at +40°C and 90±5%RH relative humidity for 96 hours. 置於+40°C, 相對濕度 90±5%環境中 96 小時	
4	Temp. cycle test 溫度循環測試	The part shall be subjected to 5 cycles. One cycle shall be consist of: 單體承受溫度循環測試 5 次, 其循環內容如圖示: 	

## H. Recommended Temperature Profile For Hand Soldering 建議手焊溫度

Hand Soldering
370±10°C / 3±1 Sec

## I. RELIABILITY TEST 信賴性試驗

No.	Item	Test conditions	Evaluation standard
1	Load test 連續負荷	0.5W white noise is applied for 24 hours, at room temp. 在室溫下,輸入功率 0.5W, 白雜音連續操作 24 小時.	Being placed for 1 hours at +25°C, speaker shall be measured. No obstacle to be harmful to normal operation; damages, cracks, rusts, etc. Should not be audible at 2.0V sine wave between Fo ~ 6.0KHz. Fo should meet initial one. S.P.L. deviation of unit should be within ±3dB. 經測試後,靜置於+25°C (室溫)環境中 1 小時後,測試後無任何障礙防礙正常操作.且在輸入 2.0V 正弦波從 Fo 到 6.0KHz 之間無異常音.Fo 與原規格值相同,輸出音壓變化量在±3dB 內.

### TEST CONDITION.

Standard Test Condition :	a) Temperature : +5 ~ +35°C	b) Humidity : 45-85%	c) Pressure : 860-1060mbar
一般測試條件 :	a) 溫度 : +5 ~ +35°C	b) 濕度 : 45-85%	c) 氣壓 : 860-1060mbar
Judgment Test Condition:	a) Temperature : +25 ± 2°C	b) Humidity : 60-70%	c) Pressure : 860-1060mbar
爭議時測試條件:	a) 溫度 : +25 ± 2°C	b) 濕度 : 60-70%	c) 氣壓 : 860-1060mbar

## J. PACKING STANDARD 包裝規格

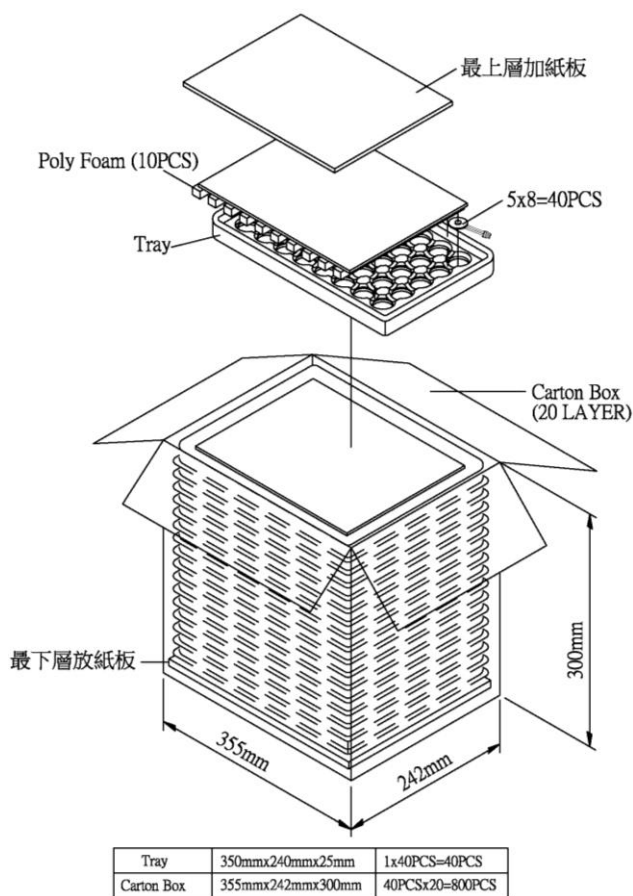

## X-ON Electronics

Largest Supplier of Electrical and Electronic Components

*Click to view similar products for [Speakers & Transducers](#) category:*

*Click to view products by [Kingstate](#) manufacturer:*

Other Similar products are found below :

[FC-30814-P127](#) [AS02832MR-2-R](#) [PB-1220PE](#) [PB-2015PQ](#) [SWFK-31736-000](#) [PT-2065FW](#) [PT-4175W](#) [ED-30761-000](#) [SMT-0440-T-2-R](#)  
[PB-0927PQ](#) [BF-9778-000](#) [SMS2020-08H4.5 LF](#) [BDT1717-08H6.5W56MLF](#) [AS03608MR-LW100-R](#) [24520](#) [SP570445-4](#) [FS2515NS0810-](#)  
[H5.5](#) [FS7033NB0830-H15.5-R01](#) [FS7833NB0830-H19.0-R01](#) [FS8030NB0850-H17.8-R01](#) [FS77DS0850-H24-R01](#) [GSPK5010TN-4R2W](#)  
[KDMG50008C-10AW](#) [KBAG3020008X-BOX2](#) [KDMG26008N-10W2](#) [KDMG28008-05WA](#) [1000](#) [3011](#) [3698](#) [3708](#) [3806](#) [3808](#) [3810](#) [3812](#)  
[3814](#) [3816](#) [3818](#) [4477](#) [4532](#) [4605](#) [4613](#) [4622](#) [4634](#) [4642](#) [4645](#) [4670](#) [4898](#) [4899](#) [4985](#) [4986](#)