

SPECIFICATION FOR APPROVAL

承認書

Description : Piezo Audio Indicator

Kingstate Part No. : KPEG276H

Customer's Model No. : _____

Specification No. : PKD-7416

Number Of The Edition : 1.5

CUSTOMER'S APPROVED SIGNATURE		



志豐電子股份有限公司 KINGSTATE ELECTRONICS CORP.

Address: 10F, No. 69-11, Sec. 2, Chung Cheng E. Rd., Tamshui County, Taipei Hsien, Taiwan, R.O.C.

International sales dept.: TEL:886-2-2809-5651 FAX:886-2-2809-7151

Domestic sales dept.: TEL:886-2-2809-0668 FAX:886-2-28096748

<http://www.kingstate.com.tw>

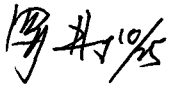
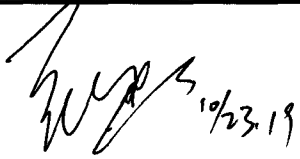
Approved by	Checked by	Issued by
	 10/23/19	陽志明 2019/10/23

A. SCOPE 範疇

This specification applies piezo audio indicator, **KPEG276H**

此規格書適用於壓電式蜂鳴器, **KPEG276H**

B. SPECIFICATION 規格

No.	Item	Unit	Specification	Condition
1	Resonant frequency 共振頻率	KHz	3.0±0.5	
2	Operating Volt. range 操作電壓範圍	VDC	8~16	
3	Current consumption 消耗電流	mA	MAX 15	at 12VDC
4	Sound pressure level 輸出音壓	dB	MIN 96	at 30cm/12VDC
5	Rated Voltage 額定電壓	VDC	12	
6	Tone 聲音		Continuous 直音	
7	Operating temp. 操作溫度	°C	-30~+80	
8	Storage temp. 儲存溫度	°C	-40~+80	
9	Dimension 尺寸	mm	φ32.0 x H14.7	See appearance drawing 請參照外觀尺寸圖
10	Weight (MAX) 重量	gram	7.2	
11	Material 材質		ABS UL-94 1/16" HB (BLACK)	
12	Terminal 端子		Pin type (鍍全錫/Plating Sn)	See appearance drawing 請參照外觀尺寸圖
13	Environmental Protection Regulation 環保法規		RoHS 2.0	
14	Storage life 保存期限	month	6	6 months preservation at room temp. (25±3°C), Humidity40% 在室溫下25±3°C,濕度40%以下可保存6個月。

C. APPEARANCE DRAWING 外觀尺寸圖

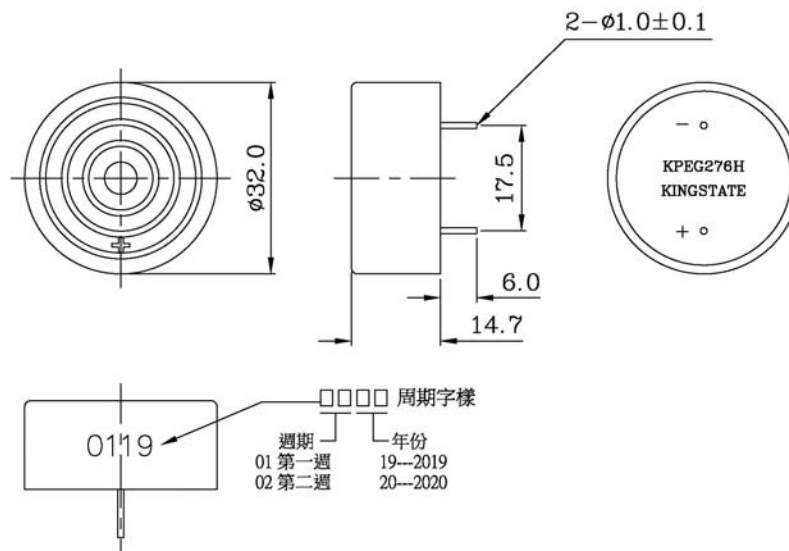

Tol : ± 0.5 Unit : mm

D. MEASURING METHOD 測量方法

S.P.L. Measuring Circuit 音壓測試接線圖

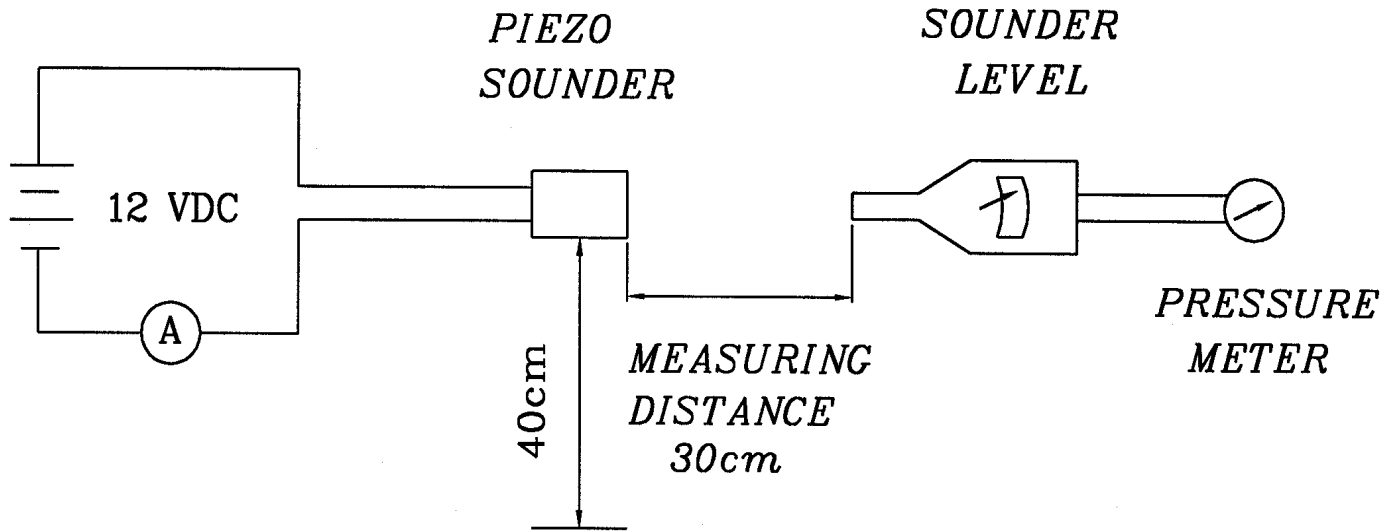

Mic : RION S.P.L meter UC30 or equivalent

Mic : RION 噪音計 UC30 或同等品

E. VOLTAGE: SOUND PRESSURE LEVEL / VOLTAGE: CURRENT CONSUMPTION

CHARACTERISTICS 電壓與音壓/電壓與耗電流之特性

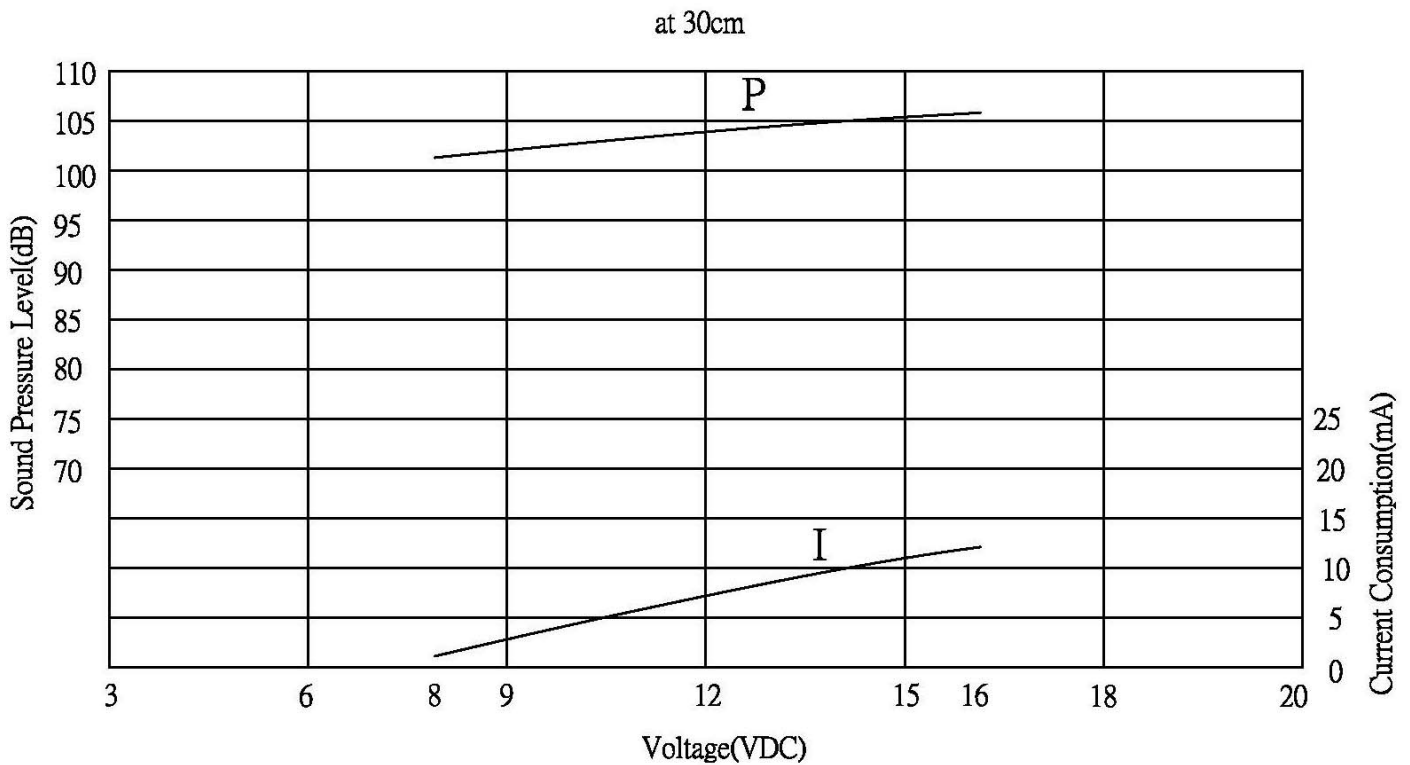

F. MECHANICAL CHARACTERISTICS 機械特性

No.	Item	Test Condition	Evaluation standard
1	Solderability 焊錫附著性	Lead terminals are immersed in rosin for 5 seconds and then immersed in solder bath of $+270\pm 5^{\circ}\text{C}$ for 3 ± 1 seconds. 端子部份浸入松香溶液 5 秒後,再浸入 $+270\pm 5^{\circ}\text{C}$ 熔融焊錫槽中 3 ± 1 秒。	90% min. lead terminals shall be wet with solder. (Except the edge of terminal) 浸入端子部份附著焊錫 90%以上。(末端斷面不算)
2	Soldering Heat Resistance 焊錫耐熱性	Lead terminal are immersed up to 1.5mm from sounder's body in solder bath of $+300\pm 5^{\circ}\text{C}$ for 3 ± 0.5 seconds or $+260\pm 5^{\circ}\text{C}$ for 10 ± 1 seconds. 距離端子根部 1.5mm 的位置,浸入 $+300\pm 5^{\circ}\text{C}$ 的焊錫槽 3 ± 0.5 秒,或 $+260\pm 5^{\circ}\text{C}$ 的焊錫槽 10 ± 1 秒。	No interference in operation 操作無任何不良
3	Terminal Mechanical Strength 端子強度	The force 10 seconds of 9.8N (1.0kg) is applied to each terminal in axial direction. 各端子的軸方向施以 9.8N (1.0kg) 的力量 10 秒。	No damage and cutting off 端子不鬆動,不脫落
4	Vibration 振動試驗	Buzzer shall be measured after being applied vibration of amplitude of 1.5mm with 10 to 55hz band of vibration frequency to each of 3 per-pendicular directions for 2 hours. 振動週波數 10~55HZ、全振幅 1.5mm 於 X.Y.Z 3 個方向,各 2 小時。	The value of oscillation frequency/ current consumption should be in 10% compared with initial ones. The SPL should be in $\pm 10\text{dB}$ compared with initial one.
5	Drop test 落下測試	The part only shall be dropped from a height of 75cm onto a 40mm thick wooden board 3 times in 3 axes (X.Y.Z). (a total of 9 times). 單體從 75 公分高處, X.Y.Z.3 個方向,各 3 回,落於 40mm 厚木板上。	諧振頻率與消耗電流變化量須在 $\pm 10\%$ 內。輸出音壓變化量須在 $\pm 10\text{dB}$ 內。

G ENVIRONMENT TEST 環境測試

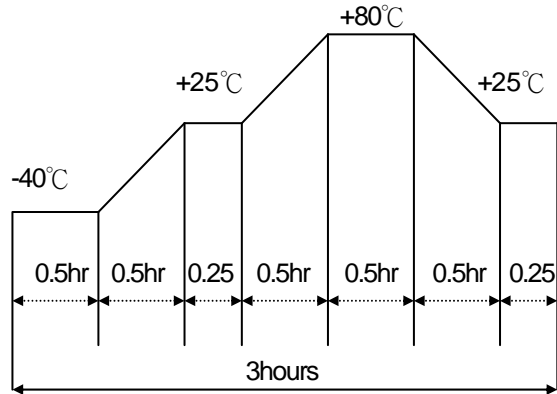
No.	Item	Test Condition	Evaluation standard
1	High temp. test 高溫測試	After being placed in a chamber at $+80^{\circ}\text{C}$ for 240 hours 置於 $+80^{\circ}\text{C}$ 環境中 240 小時	Being placed for 4 hours at $+25^{\circ}\text{C}$, buzzer shall be measured. The value of oscillation frequency/ current consumption should be in $\pm 10\%$ compared with initial ones. The SPL should be in $\pm 10\text{dB}$ compared with initial one. 經測試後,靜置於 $+25^{\circ}\text{C}$ (室溫) 環境中 4 小時後,諧振頻率與消耗電流變化量須在 $\pm 10\%$ 內。輸出音壓變化量須在 $\pm 10\text{dB}$ 內。
2	Low temp. test 低溫測試	After being placed in a chamber at -40°C for 240 hours 置於 -40°C 環境中 240 小時	
3	Humidity test 相對濕度測試	After being placed in a chamber at $+40^{\circ}\text{C}$ and $90\pm 5\%$ relative humidity for 240 hours 置於 $+40^{\circ}\text{C}$, 相對濕度 $90\pm 5\%$ 環境中 240 小時	
4	Temp. cycle test 溫度循環試驗	The part shall be subjected to 5 cycles. One cycle shall be consist of : 單體承受溫度循環測試 5 次,其循環內容如圖示: 	

H. RELIABILITY TEST 信賴性測試

No.	Item	Test condition	Evaluation standard
1	Operating life test 壽命測試	<p>1. Continuous life test 高溫壽命測試(連續) 48 hours continuous operation at +65°C with rated voltage applied. 在+65°C環境下,以額定電壓連續操作 48 小時。</p> <p>2. Intermittent life test 室溫壽命測試(間歇) A duty cycle of 1 minute on, 1 minutes off, a minimum of 5000 times at room temp. (+25±2°C) and rated voltage applied. 在室溫下(+25±2°C), 以額定電壓操作, 通電 1 分鐘/斷電 1 分鐘, 測試 5000 次循環。</p>	<p>Being placed for 4 hours at +25°C, buzzer shall be measured. The value of oscillation frequency/ current consumption should be in ±10% compared with initial ones. The SPL should be in ±10dB compared with initial one.</p> <p>經測試後, 靜置於+25°C (室溫) 環境中 4 小時後, 諧振頻率與消耗電流變化量須在±10%內. 輸出音壓變化量須在±10dB 內。</p>

TEST CONDITION.

Standard Test Condition	:	a) Temperature : +5 ~ +35°C	b) Humidity : 45-85%	c) Pressure : 860-1060mbar
一般測試條件	:	a) 溫度 : +5 ~ +35°C	b) 濕度 : 45-85%	c) 氣壓 : 860-1060mbar
Judgement Test Condition	:	a) Temperature : +25 ± 2°C	b) Humidity : 60-70%	c) Pressure : 860-1060mbar
爭議時測試條件	:	a) 溫度 : +25 ± 2°C	b) 濕度 : 60-70%	c) 氣壓 : 860-1060mbar

I. PACKING STANDARD 包裝規格

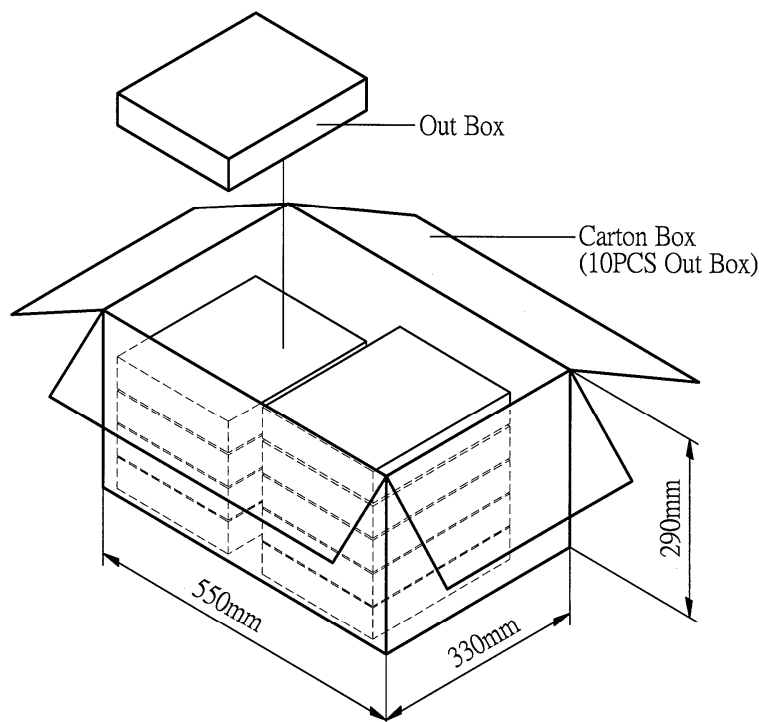
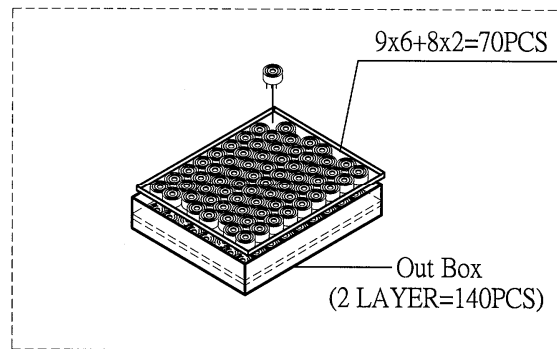

Out Box	310mmx248mmx49mm	2x70PCS=140PCS
Carton Box	550mmx330mmx290mm	140PCSx10=1400PCS

X-ON Electronics

Largest Supplier of Electrical and Electronic Components

Click to view similar products for [Piezo Buzzers & Audio Indicators](#) category:

Click to view products by [Kingstate](#) manufacturer:

Other Similar products are found below :

[6-4 ESZ-26B F/BC 40P-DR LF](#) [FDG06PSLLF](#) [FDG111PLF](#) [F/DGX12P WITH LABEL LF](#) [F/NRMB 24 BLACK LF](#) [PF-35N29WQ](#) [PFD-21A29W](#) [PFD-27A35PQ](#) [PL-21N30WQ](#) [PLD-21N30W](#) [PLD-21N30WQ](#) [PS-531Q](#) [PT-3534FP](#) [B822B](#) [B/CP28/100DB/BLACK LF](#) [S6109](#) [SC110E](#) [SC2036ACP](#) [SC616N-2](#) [SC628FW](#) [SC628MPG](#) [SC648D](#) [SCS045MD9DT3S](#) [ESZ-25B-5-250B](#) [FCM12PLF](#) [F/EB20P-DR LF](#) [AI-4228-TF-LW305-R](#) [FSMD8585JSLF](#) [F/SU 21-02 LF](#) [F/TCW 05 WITH LABEL LF](#) [F/TCW 12 WITH LABEL LF](#) [F/UCW 03 WITH LABEL LF](#) [PFD-27N36W](#) [PKM35-4A0](#) [PL-35N29WQ](#) [PLD-27A35PQ](#) [PS-552Q](#) [REF-202](#) [KBS-20DA-7AS](#) [KBS-27DA-5C-105](#) [LSC628ANR](#) [PL-21N31PQ](#) [F/DGX 05P WITH LABEL LF](#) [MSR516NP](#) [STA22702W](#) [STA20502](#) [SBM616J](#) [SBM616P](#)