

SPECIFICATION FOR APPROVAL

承 認 書

Description : Magnetic Buzzer

Kingstate Part No. : KSSGJ4D20-H

Customer's Model No. : _____

Specification No. : TKS-7280

Number Of The Edition : 1.2

CUSTOMER'S APPROVED SIGNATURE		

志豐電子股份有限公司 KINGSTATE ELECTRONICS CORP.



Address: 10F, No. 69-11, Sec. 2, Chung Cheng E. Rd., Tamshui County, Taipei Hsien, Taiwan, R.O.C.

International sales dept.: TEL : 886-2-2809-5651 FAX:886-2-2809-7151

Domestic sales dept.: TEL : 886-2-2809-0668 FAX:886-2-28096748

[http : //www.kingstate.com.tw](http://www.kingstate.com.tw)

Approved by	Checked by	Issued by
 10.04.07		 4/6

A. SCOPE 範疇

This specification applies magnetic buzzer, KSSGJ4D20-H

此規格書適用於電磁式蜂鳴器, KSSGJ4D20-H

B. SPECIFICATION 規格

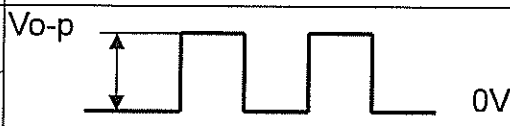
No.	Item	Unit	Specification	Condition
1	Rated Voltage 額定電壓	Vo-p	3.6	
2	Operating Volt. 操作電壓	Vo-p	3.0~5.0	
3	Mean Current 平均耗電流	mA	Max. 80	Applying rated voltage, 3100Hz square wave, 1/2duty 施以額定電壓, 3100Hz, 方波, 50%負載
4	Coil Resistance 直流阻抗	Ω	20 ± 3	
5	Sound Output 輸出音壓	dBA	Min. 95 (Typical 97)	Distance at 5cm(A-weight). Applying rated voltage 3100Hz, square wave, 1/2duty 在 5 公分處, 施以額定電壓, 3100Hz, 方波, 50%負載
6	Rated Frequency 額定頻率	Hz	3100	
7	Operating Temp. 操作溫度	$^{\circ}\text{C}$	-30 ~ +70	
8	Storage Temp. 儲存溫度	$^{\circ}\text{C}$	-40 ~ +85	
9	Dimension 尺寸	mm	L8.5 x W8.5 x H3.2	See attached drawing. 請參照外觀尺寸圖
10	Weight 重量	gram	0.7	
11	Material 材質		L.C.P (White)	
12	Terminal 端子		SMD type (鍍化金/Plating Au)	See attached drawing. 請參照外觀尺寸圖
13	Environmental Protection Regulation 環保法規		RoHS	

C. TYPICAL FREQUENCY RESPONSE CURVE 頻率響應曲線

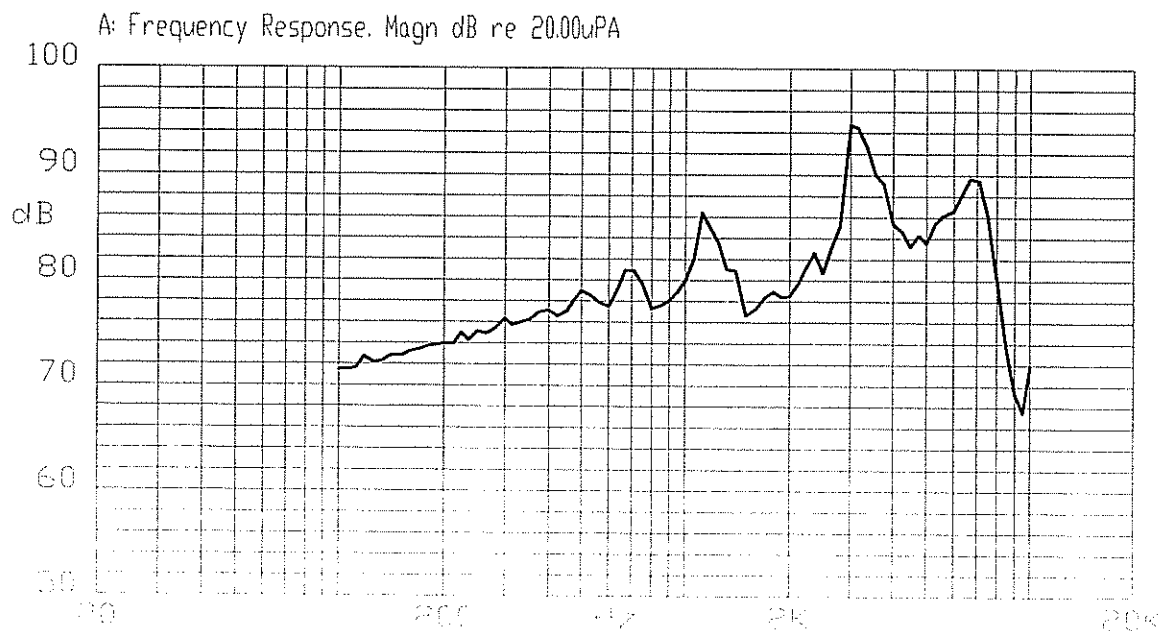

D. APPEARANCE DRAWING 外觀尺寸圖

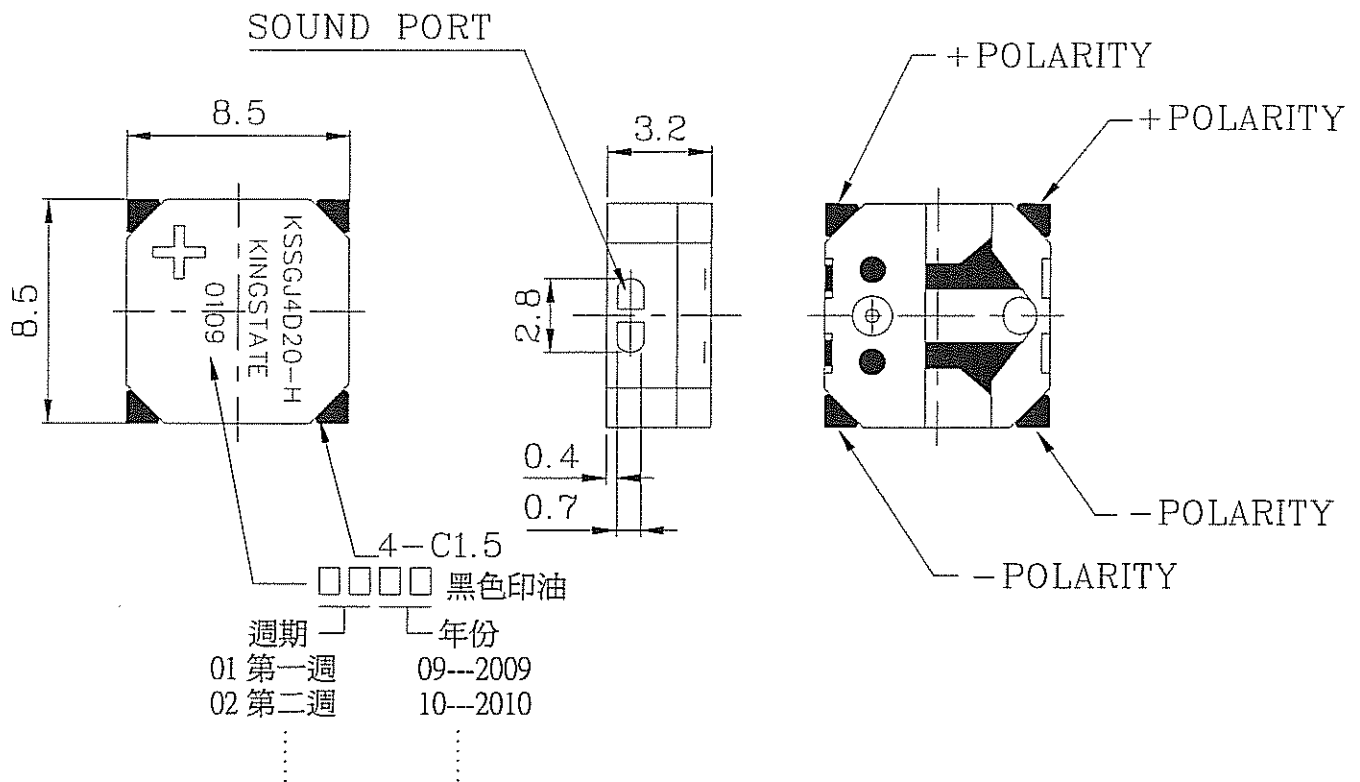

Tol : ± 0.5
Unit : mm

E. MEASUREMENT METHOD 測量方式

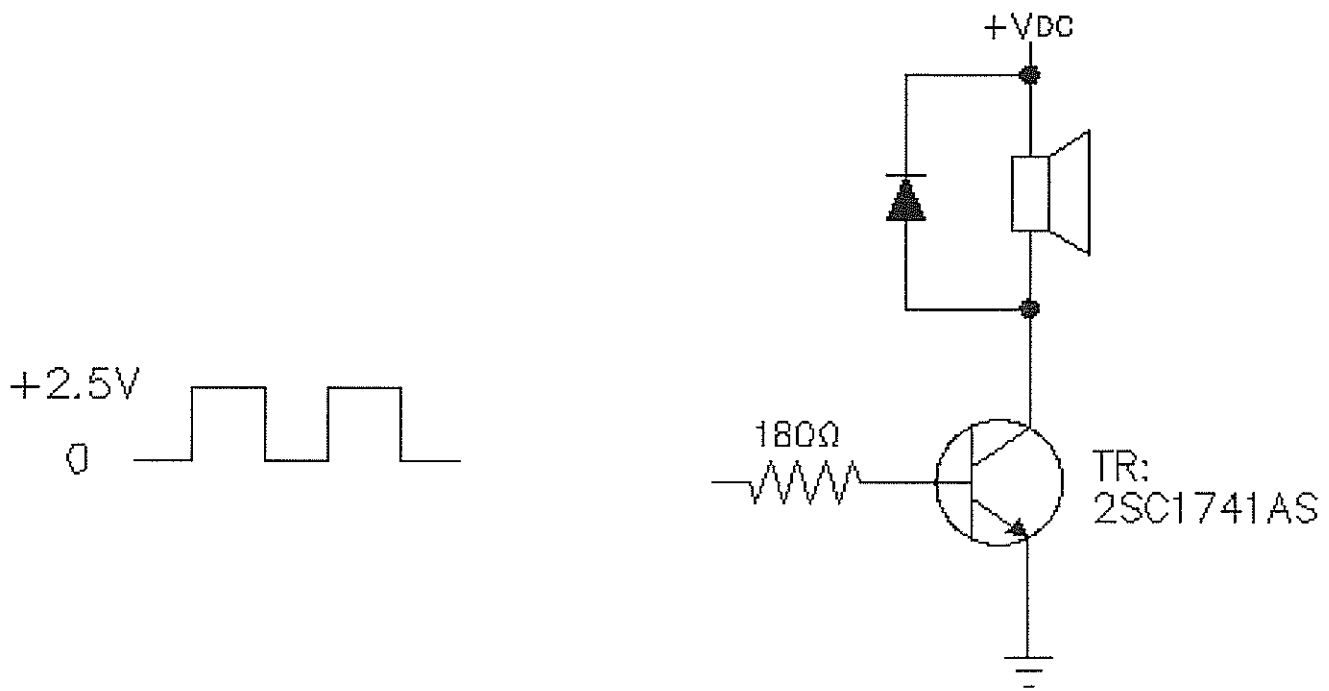

F. MECHANICAL CHARACTERISTICS 機械特性

No.	Item	Test condition	Evaluation standard
1	Solderability 焊錫附着性	Lead terminals are immersed in solder bath of $+270\pm 5^{\circ}\text{C}$ for 3 ± 1 second. 端子置於錫膏內, 錫膏溫度: $+270\pm 5^{\circ}\text{C}$. 焊接時間: 3 ± 1 秒.	95% surface of lead pads must be covered with fresh solder 錫膏須覆蓋端子上方 95%
2	Soldering Heat Resistance 焊錫耐熱性	The product is followed the reflow temperature curve to test its reflow thermostability. 產品依照迴焊溫度曲線測試迴焊耐熱性.	No interference in operation 操作無任何不良
3	Terminal Mechanical Strength 端子強度	Lead pads shall be soldered on the pc board, and the force 9.8N (1.0kg) shall be applied behind the part for 10 seconds. 將端子焊在 PC 板上後, 對單體施以 9.8N(1.0kg)拉力 10 秒.	No damage and cutting off 端子不鬆動, 不脫落.
4	Vibration 振動測試	Buzzer shall be measured after being applied vibration of amplitude of 1.5mm with 10 to 55hz band of vibration frequency to each of 3 per-pendicular directions for 2 hours. 振動週波數 10~55HZ、全振幅 1.5mm 於 X.Y.Z 3 個方向, 各 2 小時.	After the test the part shall meet specifications with-out any damage in appearance and the SPL should be in $\pm 10\text{dBA}$ compared with initial one.
5	Drop test 落下測試	The part only shall be dropped from a height of 75cm onto a 40mm thick wooden board 3 times in 3 axes (X.Y.Z). (a total of 9 times). 單體從 75 公分高處, X.Y.Z.3 個方向, 各 3 回, 落於 40mm 厚木板上.	經測試後, 單體除音壓外, 外觀及電氣特性須符合規格. 輸出音壓變化量須在 $\pm 10\text{dBA}$ 內.

G. ENVIRONMENT TEST 環境測試

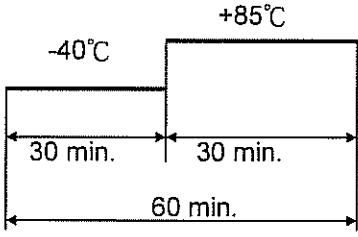
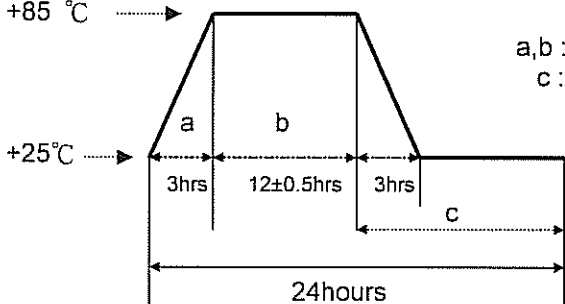
No.	Item	Test condition	Evaluation standard
1	High temp. test 高溫測試	After being placed in a chamber at $+85^{\circ}\text{C}$ for 96 hours. 置於 $+85^{\circ}\text{C}$ 環境中 96 小時	After the test the part shall meet specifications with-out any degradation in appearance and performance except SPL. after 4 hours at $+25^{\circ}\text{C}$. the SPL should be in $\pm 10\text{dBA}$ compared with initial one.
2	Low temp. test 低溫測試	After being placed in a chamber at -40°C for 96 hours. 置於 -40°C 環境中 96 小時	
3	Thermal Shock 熱衝擊試驗	The part shall be subjected to 10 cycles. One cycle shall consist of; 對單體施以熱衝擊試驗 10 次循環, 其循環內容如圖示 	
4	Temp./ Humidity Cycle 溫度/溼度循環測試	The part shall be subjected to 10 cycles. One cycle shall be 24 hours and consist of; 單體承受溫度/溼度循環測試 10 次, 其循環內容如圖示  a, b : 90~98%RH c : 80~98%RH	經測試後, 靜置於 $+25^{\circ}\text{C}$ (室溫) 環境中 4 小時後, 單體除音壓外, 外觀及電氣特性須符合規格. 輸出音壓變化量須在 $\pm 10\text{dBA}$ 內.

H. RELIABILITY TEST 信賴性測試

No.	Item	Test condition	Evaluation standard
1	Operating life test 壽命測試	<p>1. Continuous life test 高溫壽命測試(連續) The part shall be subjected to 72 hours at +55°C with 3.6V, 3100Hz applied. 在+55°C環境下, 輸入 3.6V, 3100Hz 連續操作 72 小時.</p> <p>2. Intermittent life test 室溫壽命測試(間歇) A duty cycle of 1 minute on, 1 minutes off, a minimum of 10000 times at room temp.(+25±10°C) with 3.6V, 3100Hz applied. 在室溫下(+25±10°C), 輸入 3.6V, 3100Hz 通電 1 分鐘/斷電 1 分鐘, 測試 10000 次循環.</p>	<p>After the test the part shall meet specifications with-out any degradation in appearance and performance except SPL after 4 hours at +25°C. the SPL should be in ±10dBA compared with initial one.</p> <p>經測試後, 靜置於+25°C (室溫) 環境中 4 小時後, 單體除音壓外, 外觀及電氣特性須符合規格. 輸出音壓變化量須在±10dBA 內.</p>

TEST CONDITION.

Standard Test Condition	:	a) Temperature : +5 ~ +35°C	b) Humidity : 45-85%	c) Pressure : 860-1060mbar
一般測試條件	:	a) 溫度 : +5 ~ +35°C	b) 濕度 : 45-85%	c) 氣壓 : 860-1060mbar
Judgement Test Condition	:	a) Temperature : +25 ± 2°C	b) Humidity : 60-70%	c) Pressure : 860-1060mbar
爭議時測試條件	:	a) 溫度 : +25 ± 2°C	b) 濕度 : 60-70%	c) 氣壓 : 860-1060mbar

I. Recommended Temperature Profile For Reflow Oven 建議迴焊爐溫度曲線

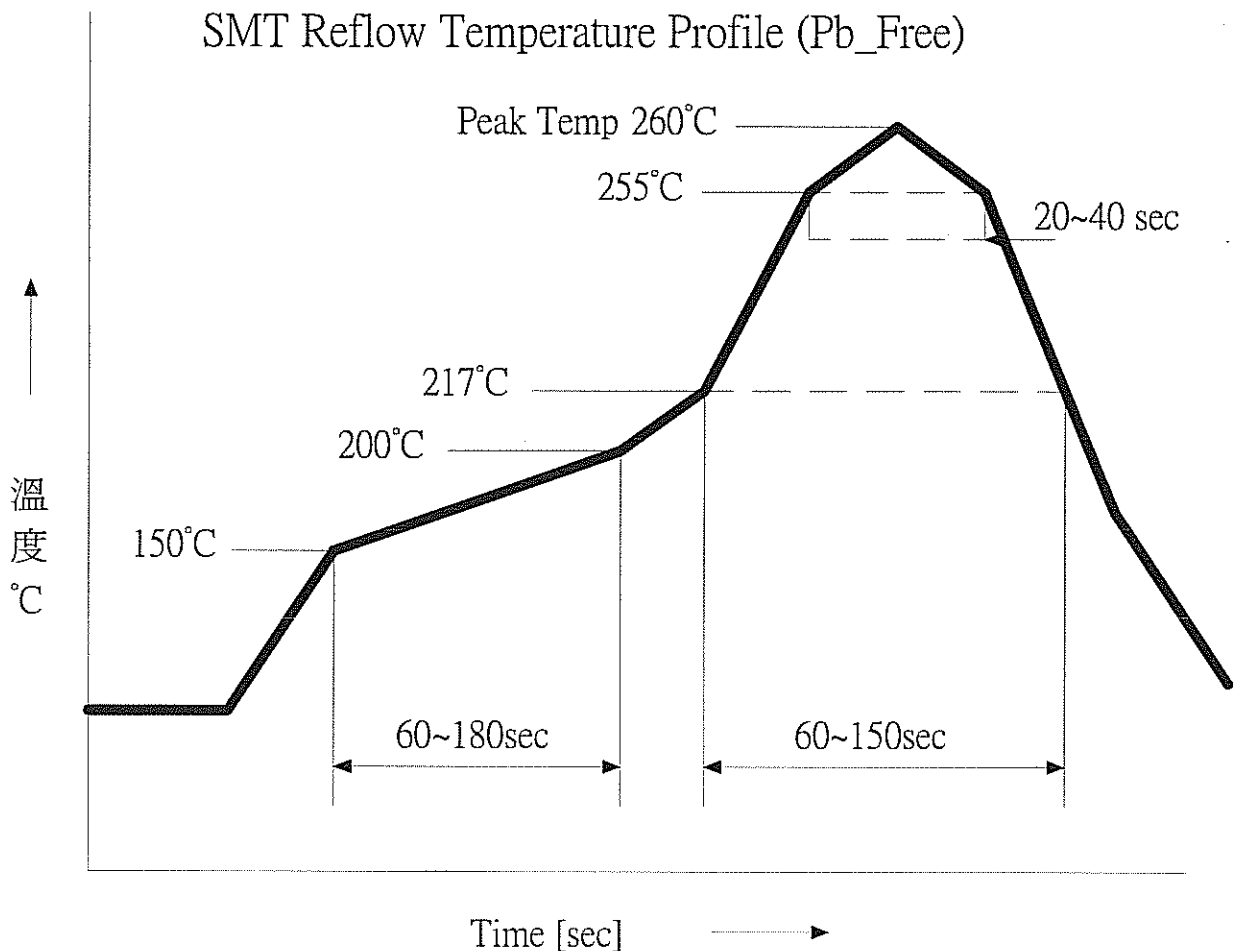

J. Recommended land pattern 建議基板設計尺寸圖

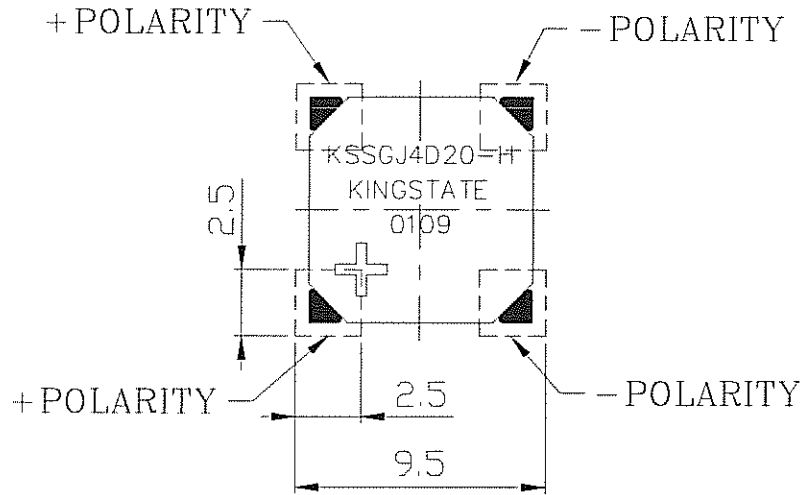

K. PACKING STANDARD 包裝規格

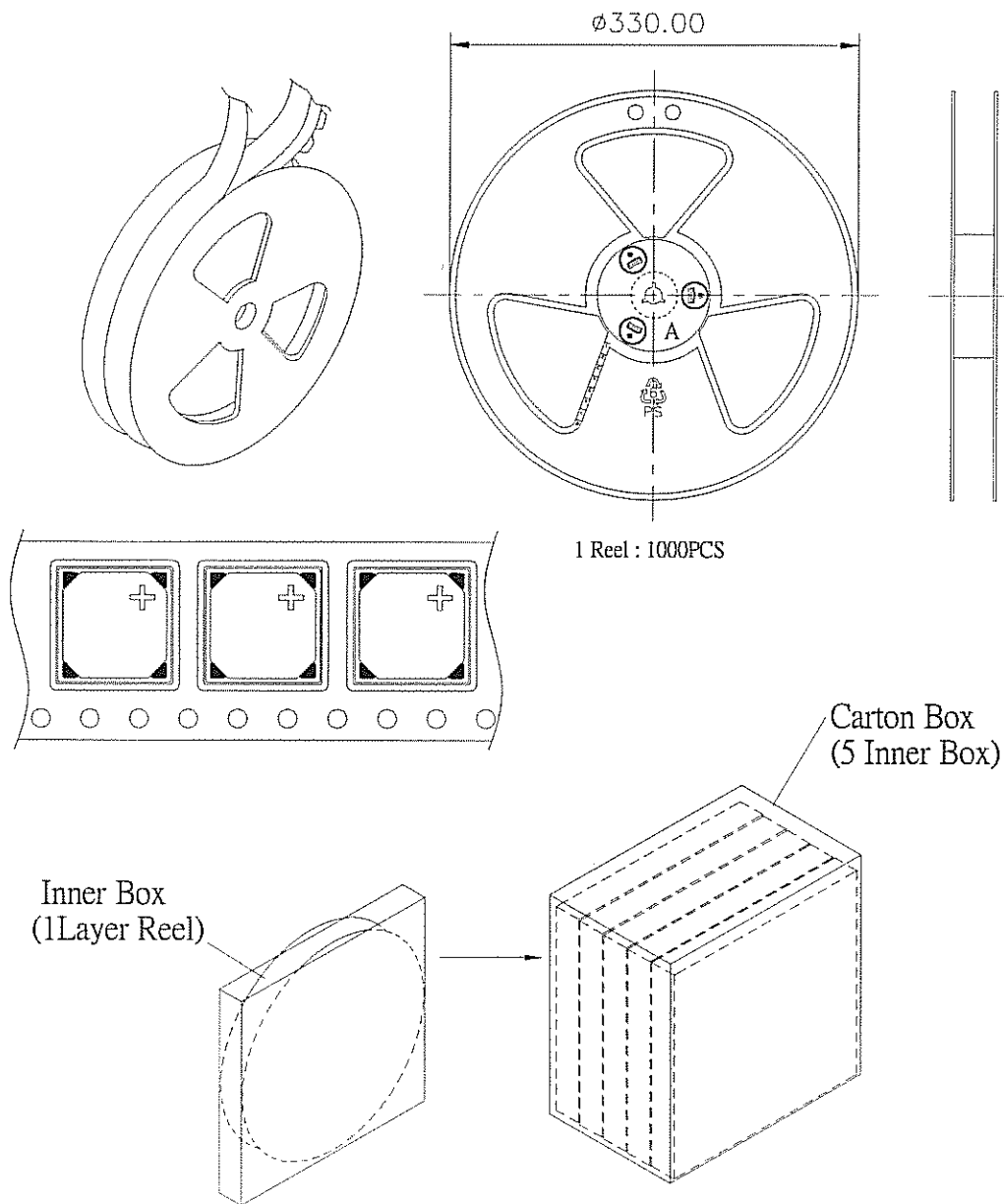

Inner Box	340mmx340mmx40mm	1x1000PCS=1000PCS
Carton Box	350mmx175mmx355mm	5x1000PCS=5000PCS

X-ON Electronics

Largest Supplier of Electrical and Electronic Components

Click to view similar products for [Piezo Buzzers & Audio Indicators](#) category:

Click to view products by [Kingstate](#) manufacturer:

Other Similar products are found below :

[6-4 ESZ-26B F/BC 40P-DR LF](#) [FDG06PSLLF](#) [FDG111PLF](#) [F/DGX12P WITH LABEL LF](#) [F/NRMB 24 BLACK LF](#) [PF-35N29WQ](#) [PFD-21A29W](#) [PFD-27A35PQ](#) [PL-21N30WQ](#) [PLD-21N30W](#) [PLD-21N30WQ](#) [PS-531Q](#) [PT-3534FP](#) [B822B](#) [B/CP28/100DB/BLACK LF](#) [S6109](#) [SC110E](#) [SC2036ACP](#) [SC616N-2](#) [SC628FW](#) [SC628MPG](#) [SC648D](#) [SCS045MD9DT3S](#) [ESZ-25B-5-250B](#) [FCM12PLF](#) [F/EB20P-DR LF](#) [AI-4228-TF-LW305-R](#) [FSMD8585JSLF](#) [F/SU 21-02 LF](#) [F/TCW 05 WITH LABEL LF](#) [F/TCW 12 WITH LABEL LF](#) [F/UCW 03 WITH LABEL LF](#) [PFD-27N36W](#) [PKM35-4A0](#) [PL-35N29WQ](#) [PLD-27A35PQ](#) [PS-552Q](#) [REF-202](#) [KBS-20DA-7AS](#) [KBS-27DA-5C-105](#) [LSC628ANR](#) [PL-21N31PQ](#) [F/DGX 05P WITH LABEL LF](#) [MSR516NP](#) [STA22702W](#) [STA20502](#) [SBM616J](#) [SBM616P](#)