

SPECIFICATION FOR APPROVAL

承 認 書

Description : **Magnetic Buzzer**

Kingstate Part No. : **KXG0903C3**

Customer's Model No. :

Specification No. : **DOD-9246**

Number Of The Edition : **1.1**

CUSTOMER'S APPROVED SIGNATURE		



志豐電子股份有限公司 KINGSTATE ELECTRONICS CORP.

Address: 10F, No. 69-11, Sec. 2, Chung Cheng E. Rd., Tamshui County, Taipei Hsien, Taiwan, R.O.C.

International sales dept.: TEL : 886-2-2809-5651 FAX:886-2-2809-7151

Domestic sales dept.: TEL : 886-2-2809-0668 FAX:886-2-28096748

http : //www.kingstate.com.tw

Approved by	Checked by	Issued by
		陽志明 2020.10.26

A. SCOPE 範疇

This specification applies magnetic buzzer, **KXG0903C3**

此規格書適用於電磁式蜂鳴器, **KXG0903C3**

B. SPECIFICATION 規格

No.	Item	Unit	Specification	Condition
1	Rated Voltage 額定電壓	V _{DC}	3.0	
2	Operating Volt. 操作電壓	V _{DC}	2.0~5.0	
3	Mean Current 平均耗電流	mA	Max. 35	
4	Sound Output 輸出音壓	dBA	Min.80 (Typical 87)	Distance at 10cm(A-weight free air). At Rated Voltage 在自由音場 10 公分處.在額定電壓下
5	Resonant Frequency 諧振頻率	Hz	2730 ± 300	
6	Operating Temp. 操作溫度	°C	-20 ~ +60	
7	Storage Temp. 儲存溫度	°C	-30 ~ +70	
8	Dimension 尺寸	mm	φ 9.6 × H5.0	See attached drawing. 請參照外觀尺寸圖
9	Weight 重量	gram	0.6	
10	Material 材質		PBT(Black)	
11	Terminal 端子		Pin type (鍍化金 Plating Au)	See attached drawing. 請參照外觀尺寸圖
12	Storage life 保存期限	month	6	6 months preservation at room temp (25±3°C), Humidity40% 在室溫下 25±3°C 濕度 40% 以下可保存 6 個月
13	Environmental Protection Regulation 環保法規		RoHS 2.0	

C. TYPICAL FREQUENCY RESPONSE CURVE 頻率響應曲線

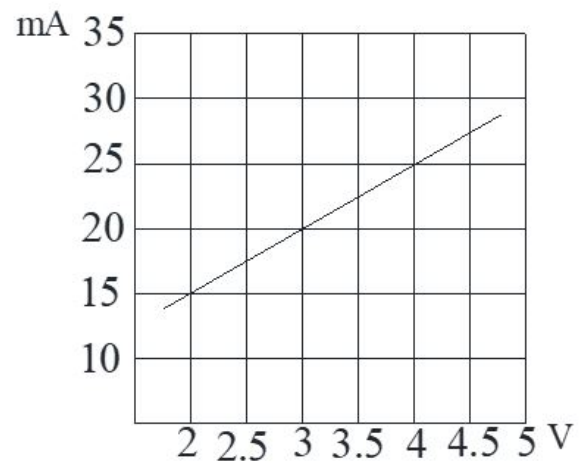
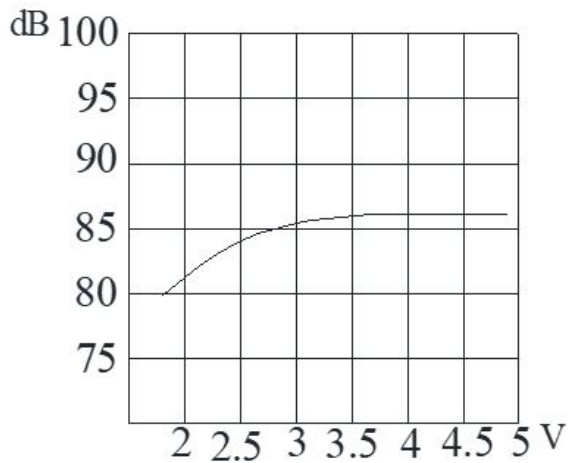

D. APPEARANCE DRAWING 外觀尺寸圖

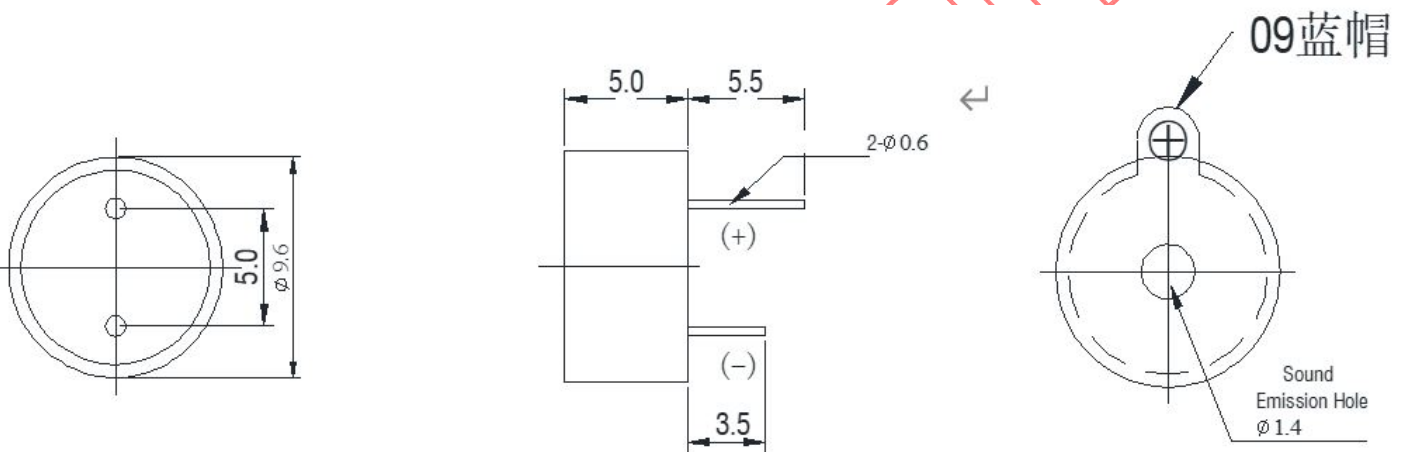

Tol: ± 0.5
Unit: mm

E. Recommended Temperature For Manual Soldering 建議手工焊接溫度

1. Hand soldering only.
只能接受手工焊接
2. Soldering temperature: $350^{\circ}\text{C} \pm 10^{\circ}\text{C}$, Max. 3.0second.
焊接條件: 350 度 \pm 10 度, Max. 3.0 秒

F. MEASUREMENT METHOD 測量方式

+V DC

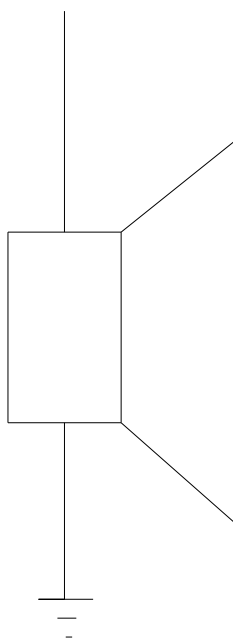

G. MECHANICAL CHARACTERISTICS 機械特性

No.	Item	Test condition	Evaluation standard
1	Solderability 焊錫附著性	Lead terminals are immersed in rosin for 5 seconds and then immersed in solder bath of $+270\pm 5^{\circ}\text{C}$ for 3 ± 1 seconds. 端子部份浸入松香溶液 5 秒後,再浸入 $+270\pm 5^{\circ}\text{C}$ 溶融焊錫槽中 3 ± 1 秒.	90% min. lead terminals shall be wet with solder. (Except the edge of terminal) 浸入端子部份附著焊錫 90%以上.(末端斷面不算)
2	Soldering Heat Resistance 焊錫耐熱性	Lead terminal are immersed up to 1.5mm from sounder's body in solder bath of $+260\pm 5^{\circ}\text{C}$ for 3 ± 1 seconds. 距離端子根部 1.5mm 的位置,浸入 $+260\pm 5^{\circ}\text{C}$ 的焊錫槽 3 ± 1 秒.	No interference in operation 操作無任何不良
3	Terminal Mechanical Strength 端子強度	The force 10 seconds of 9.8N (1.0kg) is applied to each terminal in axial direction. 各端子的軸方向施以 9.8N (1.0kg)的力量 10 秒.	No damage and cutting off 端子不鬆動, 不脫落
4	Vibration 振動測試	Buzzer shall be measured after being applied vibration of amplitude of 1.5mm with 10 to 55hz band of vibration frequency to each of 3 per-pendicular directions for 2 hours. 振動週波數 10~55HZ、全振幅 1.5mm 於 X.Y.Z 3 個方向,各 2 小時.	After the test the part shall meet specifications with-out any damage in appearance and the SPL should be in $\pm 10\text{dBA}$ compared with initial one.
5	Drop test 落下測試	The part only shall be dropped from a height of 75cm onto a 40mm thick wooden board 3 times in 3 axes (X.Y.Z). (a total of 9 times). 單體從 75 公分高處, X.Y.Z.3 個方向,各 3 回,落於 40mm 厚木板上.	經測試後,單體除音壓外,外觀及電氣特性須符合規格. 輸出音壓變化量須 $\pm 10\text{dBA}$ 內.

H. ENVIRONMENT TEST 環境測試

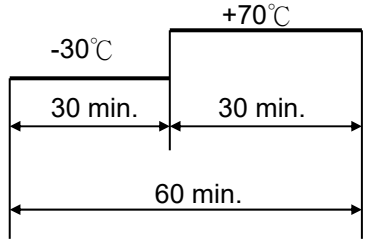
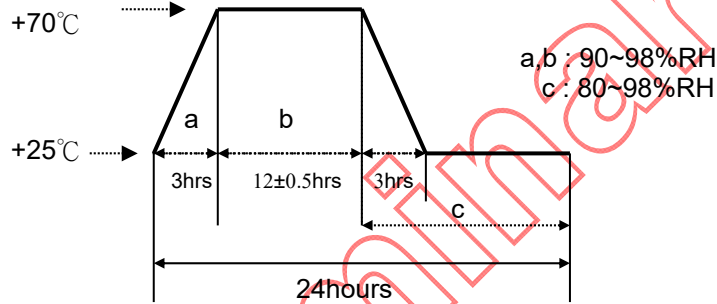
No.	Item	Test condition	Evaluation standard
1	High temp. test 高溫測試	After being placed in a chamber at +70°C for 96 hours. 置於+70°C環境中 96 小時	After the test the part shall meet specifications with-out any degradation in appearance and performance except SPL. after 4 hours at +25°C. the SPL should be in $\pm 10\text{dBA}$ compared with initial one. 經測試後，靜置於+25°C (室溫)環境中 4 小時後，單體除音壓外，外觀及電氣特性須符合規格。輸出音壓變化量須在 $\pm 10\text{dBA}$ 內。
2	Low temp. test 低溫測試	After being placed in a chamber at -30°C for 96 hours. 置於-30°C環境中 96 小時	
3	Thermal Shock 熱衝擊試驗	The part shall be subjected to 10 cycles. One cycle shall consist of; 對單體施以熱衝擊試驗 10 次循環,其循環內容如圖示 	
4	Temp./ Humidity Cycle 溫度/溼度循環測試	The part shall be subjected to 10 cycles. One cycle shall be 24 hours and consist of; 單體承受溫度/溼度循環測試 10 次. 其循環內容如圖示 	

I. RELIABILITY TEST 信賴性測試

No.	Item	Test condition	Evaluation standard
1	Operating life test 壽命測試	1. Continuous life test 高溫壽命測試(連續) The part shall be subjected to 72 hours at +45°C with 3.0VDC applied. 在+45°C環境下，輸入 3.0VDC, 連續操作 72 小時。 2. Intermittent life test 室溫壽命測試(間歇) A duty cycle of 1 minute on, 1 minutes off, a minimum of 10000 times at room temp.(+25 \pm 10°C) with 3VDC applied . 在室溫下(+25 \pm 10°C), 輸入 3VDC, 通電 1 分鐘/斷電 1 分鐘, 測試 10000 次循環。	After the test the part shall meet specifications with-out any degradation in appearance and performance except SPL. after 4 hours at +25°C. the SPL should be in $\pm 10\text{dBA}$ compared with initial one. 經測試後，靜置於+25°C (室溫)環境中 4 小時後，單體除音壓外，外觀及電氣特性須符合規格。輸出音壓變化量須在 $\pm 10\text{dBA}$ 內。

TEST CONDITION.

Standard Test Condition	: a) Temperature : +5 ~ +35°C	b) Humidity : 45-85%	c) Pressure : 860-1060mbar
一般測試條件	: a) 溫度 : +5 ~ +35°C	b) 濕度 : 45-85%	c) 氣壓 : 860-1060mbar
Judgement Test Condition	: a) Temperature : +25 \pm 2°C	b) Humidity : 60-70%	c) Pressure : 860-1060mbar
爭議時測試條件	: a) 溫度 : +25 \pm 2°C	b) 濕度 : 60-70%	c) 氣壓 : 860-1060mbar

J. PACKING STANDARD 包裝規格

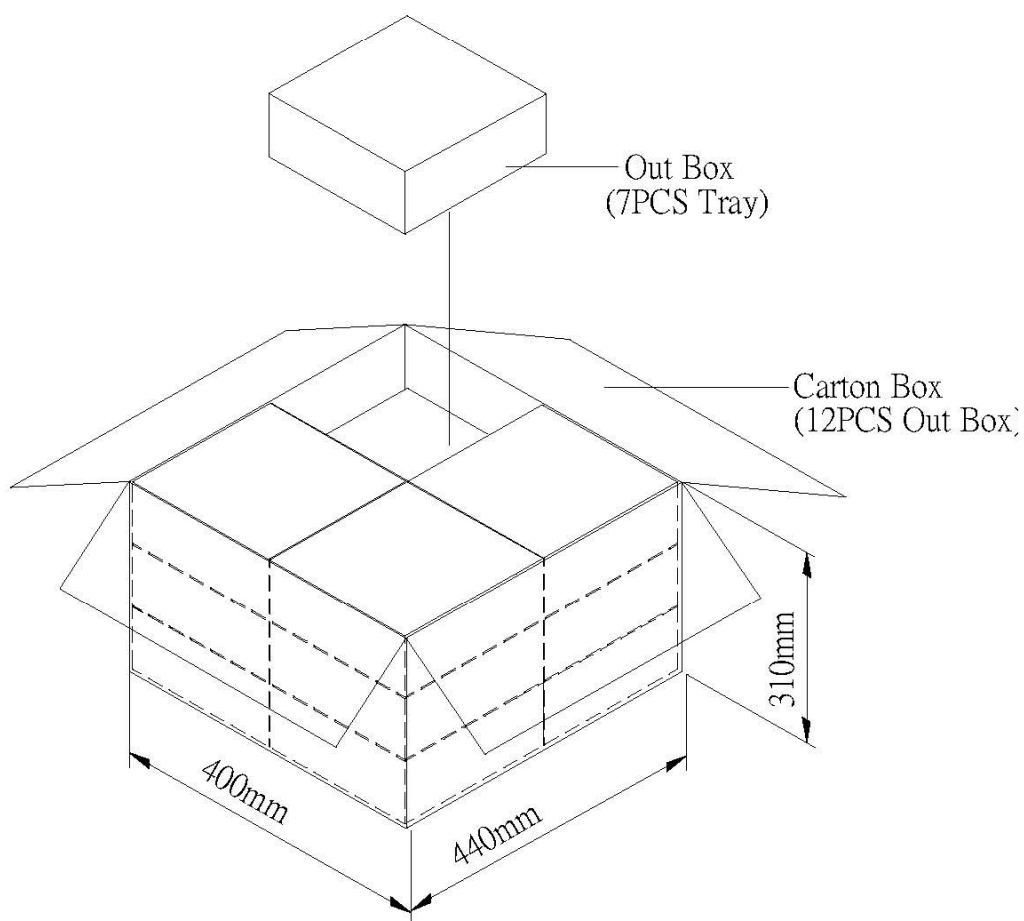
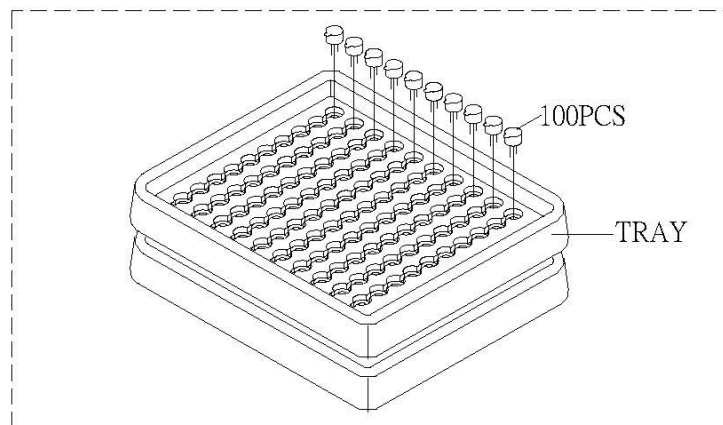

包裝箱	长×宽×高 (mm)	包裝数量 (只)
吸塑盒	184×184×23	100
小纸箱	200×190×100	700
大纸箱	440×400×310	8400

X-ON Electronics

Largest Supplier of Electrical and Electronic Components

Click to view similar products for [Piezo Buzzers & Audio Indicators](#) category:

Click to view products by [Kingstate](#) manufacturer:

Other Similar products are found below :

[6-4 ESZ-26B F/BC 40P-DR LF](#) [FDG06PSLLF](#) [FDG111PLF](#) [F/DGX12P WITH LABEL LF](#) [F/NRMB 24 BLACK LF](#) [PF-35N29WQ](#) [PFD-21A29W](#) [PFD-27A35PQ](#) [PL-21N30WQ](#) [PLD-21N30W](#) [PLD-21N30WQ](#) [PS-531Q](#) [PT-3534FP](#) [B822B](#) [B/CP28/100DB/BLACK LF](#) [S6109](#) [SC110E](#) [SC2036ACP](#) [SC616N-2](#) [SC628FW](#) [SC628MPG](#) [SC648D](#) [SCS045MD9DT3S](#) [ESZ-25B-5-250B](#) [FCM12PLF](#) [F/EB20P-DR LF](#) [AI-4228-TF-LW305-R](#) [FSMD8585JSLF](#) [F/SU 21-02 LF](#) [F/TCW 05 WITH LABEL LF](#) [F/TCW 12 WITH LABEL LF](#) [F/UCW 03 WITH LABEL LF](#) [PFD-27N36W](#) [PKM35-4A0](#) [PL-35N29WQ](#) [PLD-27A35PQ](#) [PS-552Q](#) [REF-202](#) [KBS-20DA-7AS](#) [KBS-27DA-5C-105](#) [LSC628ANR](#) [PL-21N31PQ](#) [F/DGX 05P WITH LABEL LF](#) [MSR516NP](#) [STA22702W](#) [STA20502](#) [SBM616J](#) [SBM616P](#)