

PRODUCT NO.	DISCO4LHGET
RoHS compliant	

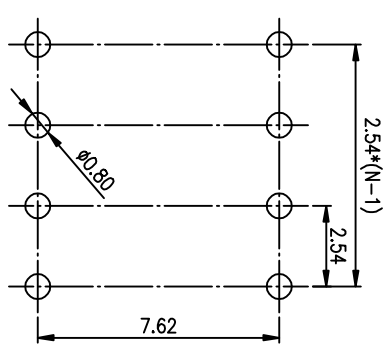

RECOMMENDED P.C.B. LAYOUT (TOP VIEW)

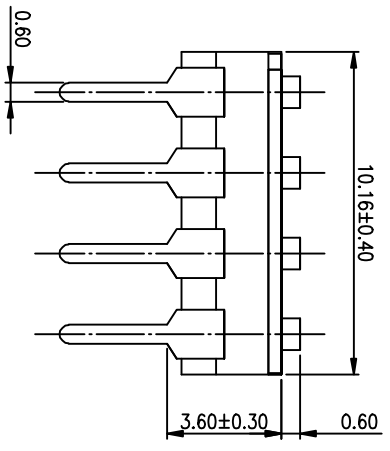
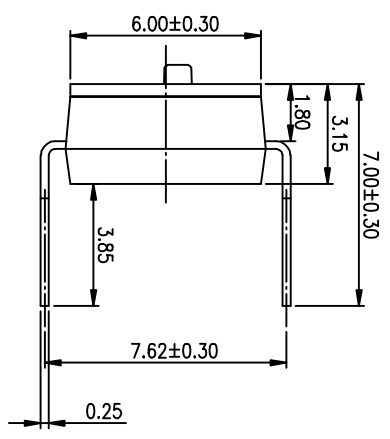
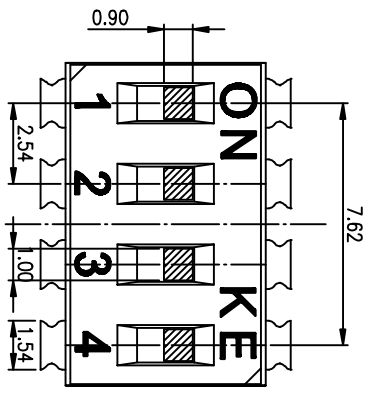
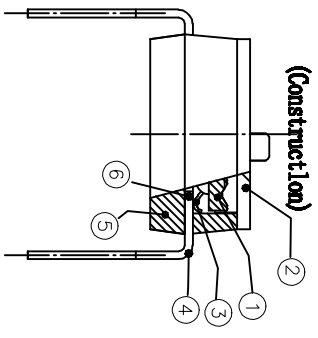

(Construction)

NOTES :

- 1.> Specification:
 1> Operating force: 1000gf Max
 2> Operating Temperature: -40° to +85°
 3> Storage Temperature: -40° to +85°
 4> Mechanical Life: 3000cycles minimum
 5> Electrical Life: 2000cycles 25mA 24VDC
2. PLATING:
 GOLD FLASH 1u"(min.) SOLDER TAIL,
 3u" GOLD PLATING ON THE CONTACT AREA,
 WITH 50u" NICKEL UNDERPLATING OVERALL.

3. PART NUMBER DESCRIPTION

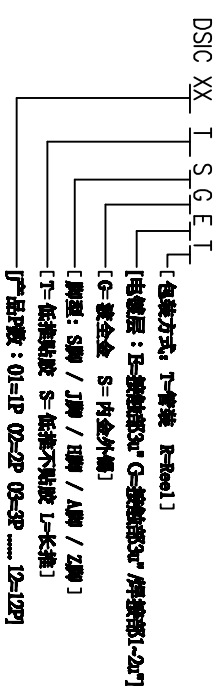

[Schematic]

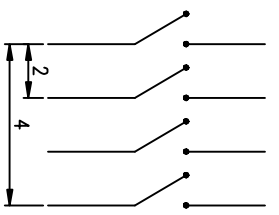

[推行程]

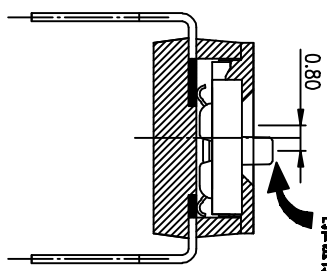

Number	Part Name	Material	Finished
①	Actuator	UL94 V0	White
②	Cover	UL94 V0	Black
③	Movable	Copper Alloy	3u"Gold
④	Terminal	Brass	1u"Gold
⑤	Base	UL94 V0	Black
⑥	Terminal Contact	Brass	3u"Gold

TOLERANCE UNLESS OTHERWISE SPECIFIED		INSPECTION	
LINER	ANGLES	COPY	PROJECTION
0 ± 0.25	0 ± 2'		
.00 ± 0.15	.0 ± 1'		
.000 ± 0.10	.00 ± 0.5'		

FILE NO.	DISCO4LHGET-A
SIZE	UNIT SCALE SHEET REV.
A4	mm 2 : 1 1 OF 1 A

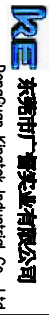

BY DISC SERIES PITCH 2.54mm

PRODUCT FAMILY DISC SERIES

PRAT NO. DISCO4LHGET

X-ON Electronics

Largest Supplier of Electrical and Electronic Components

Click to view similar products for [DIP Switches/SIP Switches](#) category:

Click to view products by [Kingtek Industrial](#) manufacturer:

Other Similar products are found below :

[79B10T](#) [8136-475G4T](#) [G7G-1A2-CB-DC12](#) [H7CZL8AC100240](#) [DRR60016](#) [DRS4016](#) [1825444-1](#) [200183](#) [206002](#) [206004LPST](#) [219-6LPSTRF](#) [25.350.0653.0](#) [SBS 5004 TG](#) [SDA10H1BDA](#) [97R06ST](#) [A2C-2A5](#) [1825444-7](#) [ADE08SA04](#) [ADE12S04](#) [192960010](#) [206005RAS](#) [206007](#) [2-1825058-8](#) [25.330.0653.1](#) [25.352.0353.0](#) [CXDRIVEV2X](#) [IKN0600000](#) [IKN0800000](#) [LA2-002-DC24](#) [DBS2110](#) [DSR02T](#) [E2FMX2D1M1TGJ03M](#) [NDI10H](#) [219-9MSTP](#) [EPM02FV](#) [206010RAST](#) [NDS08V](#) [76SB05](#) [TD06H0SK1](#) [Z7.255.9027.0](#) [1-1825058-3](#) [1825428-4](#) [219-10LPSTF](#) [E3ZG6111D03M](#) [G4D212PUSTV2DC5](#) [HARW0002](#) [EPG301BT06](#) [219-7LPSTRF](#) [1-1825058-6](#) [E3TSL23M5J03M](#)