

PRODUCT NO.	1
DISCO61SGE1	RAIS compliant

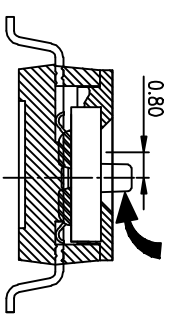

(Construction)

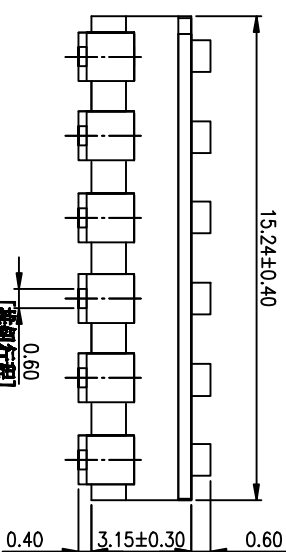
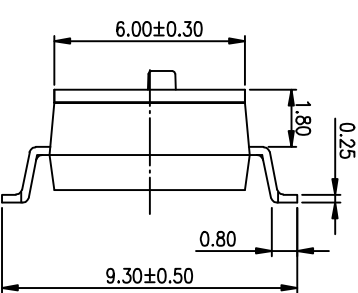
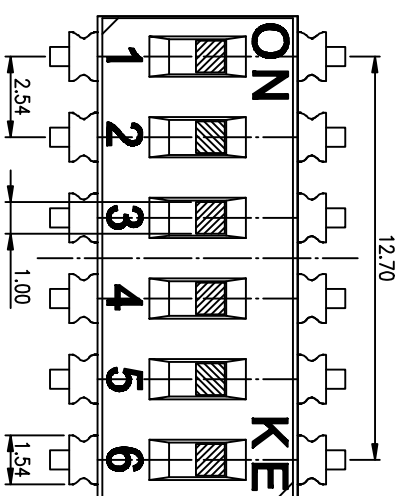
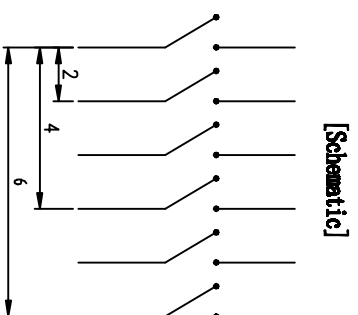
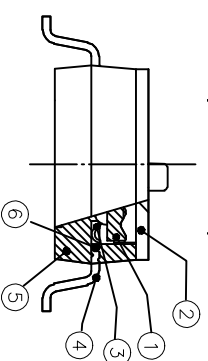

[Schematic]

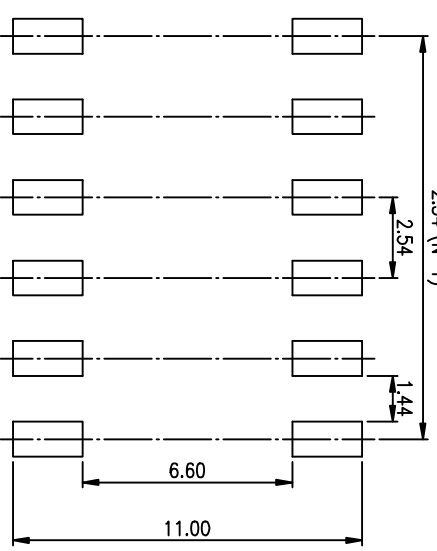

RECOMMENDED P.C.B. LAYOUT (TOP VIEW)

- NOTES :
- 1.> Specification:
 - 1> Operating force: 1000gf Max
 - 2> Operating Temperature: -40° to+85°
 - 3> Storage Temperature: -40° to+85°
 - 4> Mechanical Life: 3000cycles minimum
 - 5> Electrical Life: 2000cycles minimum
 2. PLATING:
 - GOLD FLASH 1u"(min.) SOLDER TAIL,
 - 3u" GOLD PLATING ON THE CONTACT AREA,
 - WITH 50u" NICKEL UNDERPLATING OVERALL.

3. PART NUMBER DESCRIPTION

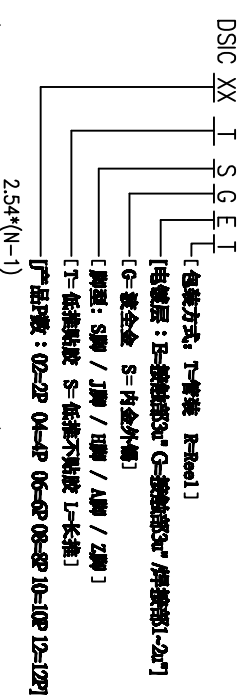

Number	Part Name	Material	Finished
①	Actuator	UL94 V0	White
②	Cover	UL94 V0	Black
③	Movable	Copper Alloy	3u"Gold
④	Terminal	Brass	1u"Gold
⑤	Base	UL94 V0	Black
⑥	Terminal Contact	Brass	3u"Gold

TOLERANCE UNLESS OTHERWISE SPECIFIED		INSPECTION COPY	
LINER	ANGLES	PROJECTION	
0 ± 0.25	0 ± 2'		
.00 ± 0.15	.0 ± 1'		
.000± 0.10	.00± 0.5'		
DESIGN	kathy	2012/04/12	
DRAWING			
CHECK			
APPRO.			

東莞市廣業有限公司	DR	DATE
Dongguan Kingtek Industrial Co., Ltd.		
BY DISC SERIES PITCH 2.54mm	REV.	
PRODUCT FAMILY DISC SERIES		
PRAT NO. DISCO61SGE1		
FILE NO. DISCO61SGE1-A		
SIZE UNIT SCALE SHEET		
A4 mm 2 : 1 1OF 1		

X-ON Electronics

Largest Supplier of Electrical and Electronic Components

Click to view similar products for [DIP Switches/SIP Switches](#) category:

Click to view products by [Kingtek Industrial](#) manufacturer:

Other Similar products are found below :

[79B10T](#) [8136-475G4T](#) [G7G-1A2-CB-DC12](#) [H7CZL8AC100240](#) [DRR60016](#) [DRS4016](#) [1825444-1](#) [200183](#) [206002](#) [206004LPST](#) [219-6LPSTRF](#) [25.350.0653.0](#) [SBS 5004 TG](#) [SDA10H1BDA](#) [97R06ST](#) [A2C-2A5](#) [1825444-7](#) [ADE08SA04](#) [ADE12S04](#) [192960010](#) [206005RAS](#) [206007](#) [2-1825058-8](#) [25.330.0653.1](#) [25.352.0353.0](#) [CXDRIVEV2X](#) [IKN0600000](#) [IKN0800000](#) [LA2-002-DC24](#) [DBS2110](#) [DSR02T](#) [E2FMX2D1M1TGJ03M](#) [NDI10H](#) [219-9MSTP](#) [EPM02FV](#) [206010RAST](#) [NDS08V](#) [76SB05](#) [TD06H0SK1](#) [Z7.255.9027.0](#) [1-1825058-3](#) [1825428-4](#) [219-10LPSTF](#) [E3ZG6111D03M](#) [G4D212PUSTV2DC5](#) [HARW0002](#) [EPG301BT06](#) [219-7LPSTRF](#) [1-1825058-6](#) [E3TSL23M5J03M](#)