

PRODUCT NO.	RoHS compliant
DSIC12LSGET	

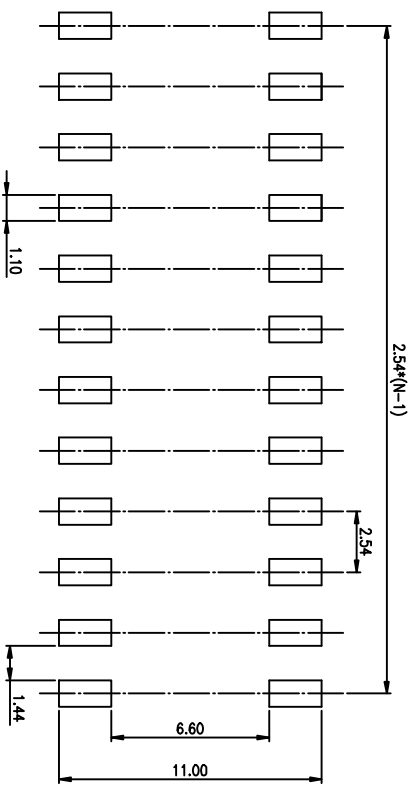

- NOTES :
- 1> Specification:
    - 1> Operating force: 1000gf Max
    - 2> Operating Temperature: -40° to+85°
    - 3> Storage Temperature: -40° to+85°
    - 4> Mechanical Life: 3000cycles minimum
    - 5> Electrical Life: 2000cycles minimum
  2. PLATING:
    - GOLD FLASH 1u"(min.) SOLDER TAIL,
    - 3u" GOLD PLATING ON THE CONTACT AREA,
    - WITH 50u" NICKEL UNDERPLATINGOVERALL.

3. PART NUMBER DESCRIPTION

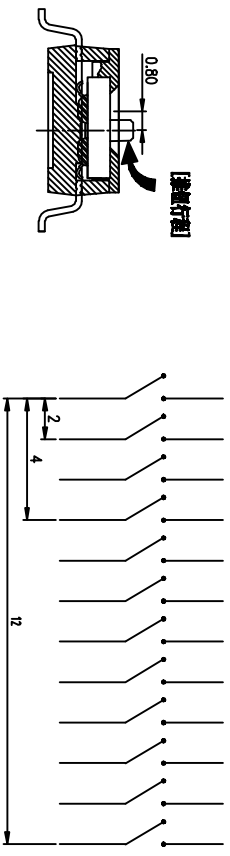
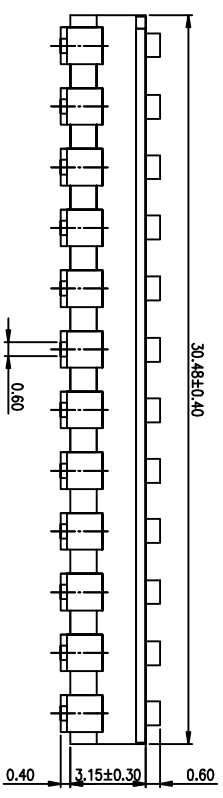
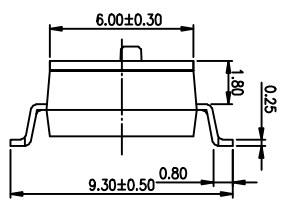
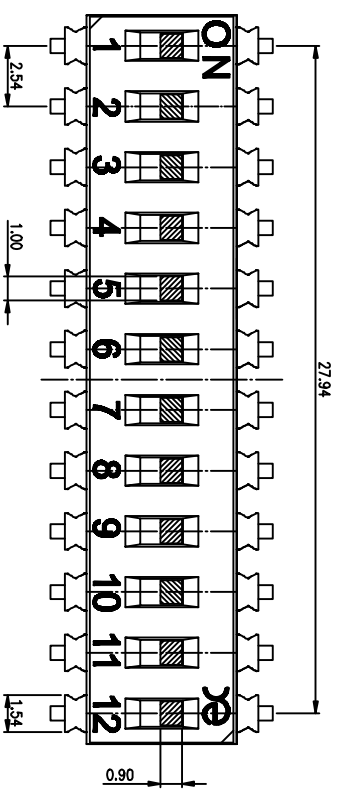
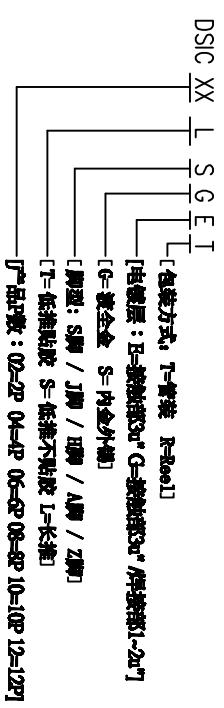

(Construction)

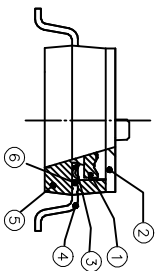

Number	Part Name	Material	Finished
①	Actuator	UL94 V0	White
②	Cover	UL94 V0	Black
③	Movable	Copper Alloy	3u"Gold
④	Terminal	Brass	1u"Gold
⑤	Base	UL94 V0	Black
⑥	Terminal Contact	Brass	3u"Gold

TOLERANCE UNLESS OTHERWISE SPECIFIED		INSPECTION	
LINER	ANGLES	COPY	PROJECTION
0 ± 0.25	0. ± 2'		
.00 ± 0.15	.0 ± 1'		
.000 ± 0.10	.00 ± 0.5'		
DESIGN	kathy	2012/04/12	
DRAWING			
CHECK			
APPRO.			

东莞市广客实业有限公司 Dongguan Kingtek Industrial Co., Ltd.			
TITLE			
BY DSIC SERIES PITCH 2.54mm			
PRODUCT FAMILY DSIC SERIES			
FILE NO.	DSIC12LSGET	A	
SIZE	UNIT	SCALE	SHEET
A4	mm	2 : 1	1 OF 1

## X-ON Electronics

Largest Supplier of Electrical and Electronic Components

*Click to view similar products for [DIP Switches/SIP Switches](#) category:*

*Click to view products by [Kingtek Industrial](#) manufacturer:*

Other Similar products are found below :

[79B10T](#) [8136-475G4T](#) [G7G-1A2-CB-DC12](#) [H7CZL8AC100240](#) [DRR60016](#) [DRS4016](#) [1825444-1](#) [200183](#) [206002](#) [206004LPST](#) [219-6LPSTRF](#) [25.350.0653.0](#) [SBS 5004 TG](#) [SDA10H1BDA](#) [97R06ST](#) [A2C-2A5](#) [1825444-7](#) [ADE08SA04](#) [ADE12S04](#) [192960010](#) [206005RAS](#) [206007](#) [2-1825058-8](#) [25.330.0653.1](#) [25.352.0353.0](#) [CXDRIVEV2X](#) [IKN0600000](#) [IKN0800000](#) [LA2-002-DC24](#) [DBS2110](#) [DSR02T](#) [E2FMX2D1M1TGJ03M](#) [NDI10H](#) [219-9MSTP](#) [EPM02FV](#) [206010RAST](#) [NDS08V](#) [76SB05](#) [TD06H0SK1](#) [Z7.255.9027.0](#) [1-1825058-3](#) [1825428-4](#) [219-10LPSTF](#) [E3ZG6111D03M](#) [G4D212PUSTV2DC5](#) [HARW0002](#) [EPG301BT06](#) [219-7LPSTRF](#) [1-1825058-6](#) [E3TSL23M5J03M](#)