

# Profile LARKO

Ref. A05552

Ref. arch B5552

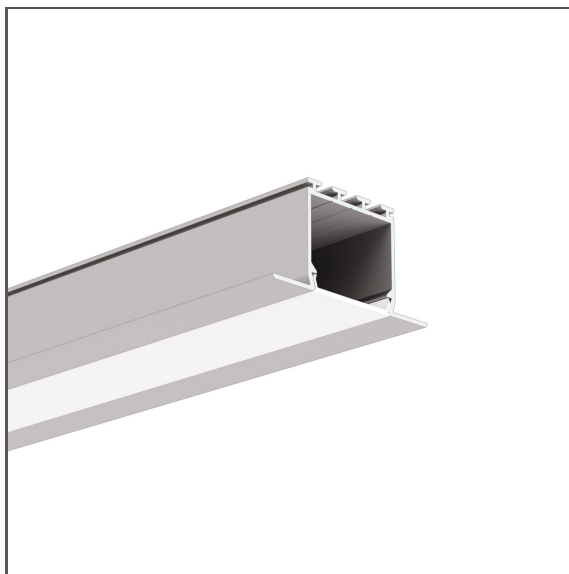

- Mounting to drywall
- Invisible groove edge
- Possibility to mount the power supply in the luminous part of the luminaire

## APPLICATION

- main and decorative lighting

## MOUNTING

- recessed, using dedicated accessories
- can be easily connected into runs and systems

## ADDITIONAL INFORMATION

- standard lengths of KLUŚ profiles and covers: 1000 mm (tolerance  $\pm 1.5$  mm) and 2005 mm / 3010 mm (tolerance + 5 mm); for selected covers: 6050 mm, 10050 mm (tolerance + 5 mm)
- when choosing a different length of profiles / covers than available in the standard, you should additionally choose the cutting service at KLUŚ

## TECHNICAL DRAWING

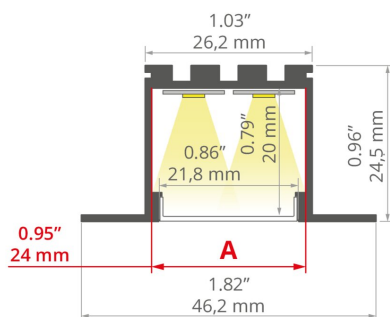

## TECHNICAL SPECIFICATIONS

Material	aluminum
Possible fixture IP	20, 65
Possible fixture shapes	linear, polygonal
Profile cross-section	rectangular
Width	46.2 mm
Height	24.5 mm
LED gluing width A	24 mm
Number of LED strips A (8 mm wide)	2
Max power of a single KLUŚ LED strip	24 W/m
Possibility of obtaining a line of light	yes
Building type	Commercial, Entertainment/ Arts, HoReCa object
Facility zone	office, communication routes and corridors, conference room, lobby / foyer
The cover is cut to the length of the profile	yes
Can be easily connected into runs	yes
Mounting to drywall	yes
Wire out back of extrusion	yes

Color	Length	Ref
■ silver anodized	1000 mm	A05552A_1 B5552ANODA_1
	2005 mm	A05552A_2 B5552ANODA_2
	3010 mm	A05552A_3 B5552ANODA_3
□ white lacquered	2005 mm	A05552L10OD_2 B5552L9010OD_2
	1000 mm	A05552L10OD_1 B5552L9010OD_1
	3010 mm	A05552L10OD_3 B5552L9010OD_3

# Profile LARKO



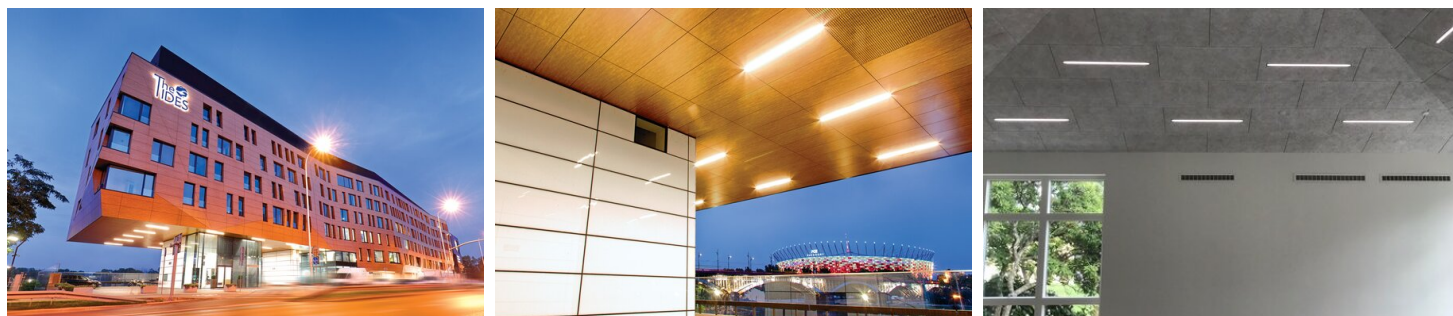

Ref. A05552

Ref. arch B5552





## SAMPLE PROJECTS



## RELATED ACCESSORIES > COVERS

NAME	MATERIAL	MATERIAL TRANSMITTANCE	COLOR	REF.	
LIGER		PC	62 %	satin	B17032S 17032V1
			39 %	black	B17032B 17087
HS		PC	73 %	frosted	B17011F 17011
			94 %	clear	B17011C 17022
G		PMMA	69 %	satin	B17006S 17010
			85 %	semi-transparent	B17006T 17017
			95 %	clear	B17006C 17006
MUN-22		PC	30 %	black	B17006B 17012
			86 %	semi-transparent	B17042F 17042

## RELATED ACCESSORIES > END CAPS

NAME	MATERIAL	COLOR	REF.
LARKO		 gray	C24006C02 24006
		 silver	C24006L01 24102
		 white	C24006C10 24410

# Profile LARKO

Ref. A05552

Ref. arch B5552

## RELATED ACCESSORIES > RELATED LED

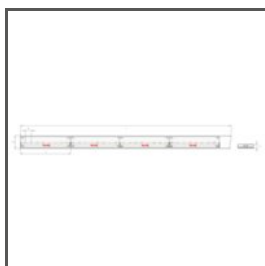

**WP-K-30/18-1770-010V-24V**  
WP-K-30/18-1770-010V-24V  
Ref. arch WP-K-30/18-1770-010V-24V

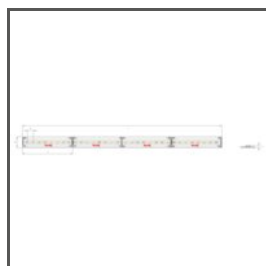

**K-30/18-1770-010V-24V**  
K-30/18-1770-010V-24V  
Ref. arch K-30/18-1770-010V-24V

## RELATED ACCESSORIES > RELATED LED > ADJUSTABLE WHITE / DIM TO WARM



**K-27/50-1440-24V**  
K-27/50-1440-24



**KWP-27/50-1440-24**  
KWP-27/50-1440-24

## RELATED ACCESSORIES > RELATED LED > CRI 95+



**WP-K-CR-1820-HD-24V**  
WPKCR1820HD24  
Ref. arch WPKCR1820HD24V

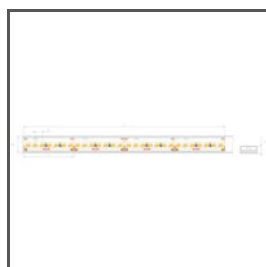

**WP-K-CR-1910-HD-24V**  
KWP-CRHD-1910-24  
Ref. arch WPK-CR-1910-HD-24V

## RELATED ACCESSORIES > RELATED LED > HIGH EFFICACY

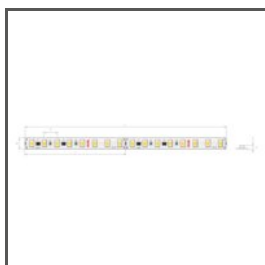

**K-HE-0480-HD-24V**  
K-HEHD-0480-24  
Ref. arch K-HE-0480-HD-24V

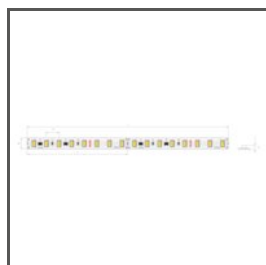

**K-HE-0960-HD-24V**  
K-HEHD-0960-24  
Ref. arch K-HE-0960-HD-24V

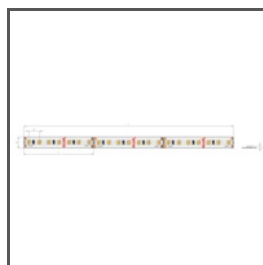

**K-HE-1440-HD-24V**  
K-HEHD-1440-24  
Ref. arch K-HE-1440-HD-24V

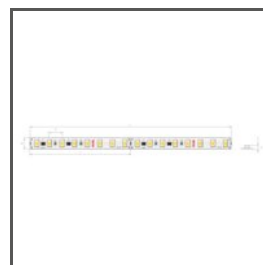

**K-HE-1920-HD-24V**  
K-HEHD-1920-24  
Ref. arch K-HE-1920-HD-24V

RELATED ACCESSORIES > RELATED LED > RGB / RGB-W / RGB-CTT

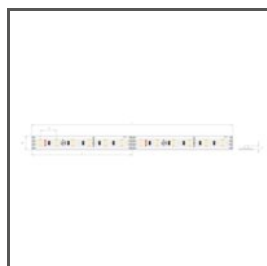

**K-1275-RGB-24V**  
K-RGB-1275-24  
Ref. arch K-1275-RGB-24V

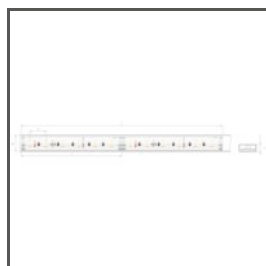

**WP-K-1275-RGB-24V**  
KWP-RGB-1275-24  
Ref. arch WP-K-1275-RGB-24V

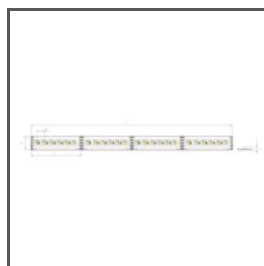

**K-1530-RGB+W-24V**  
K-RGBW-1530-24  
Ref. arch K-1530-RGB+W-24V



**WP-K-1530-RGB+W-24V**  
KWP-RGBW-1530-24  
Ref. arch WP-K-1530-RGB+W-24V



**K-1920-120-RGB-24V**  
K-RGB-1920-120-24  
Ref. arch K-1920-120-RGB-24V

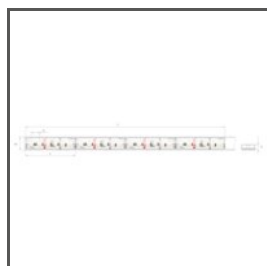

**WP-K-1920-120-RGB-24V**  
KWP-1920-120-RGB-24  
Ref. arch WP-K-1920-120-RGB-24V



**K-1200-RGB+27/65-24V**  
K-RGB27/65-1200-24  
Ref. arch K-1200-RGB+27/65-24V



**K-RGB-1200-24V**  
K-RGB-1200-24  
Ref. arch K-RGB-1200-24V



**K-RGB-0700-24V**  
K-RGB-0700-24  
Ref. arch K-RGB-0700-24V

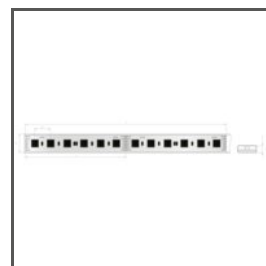

**WP-K-1200-RGB+27/65-24V**  
WPK-RGB27/65-1200-24  
Ref. arch WP-K-1200-RGB+27/65-24V

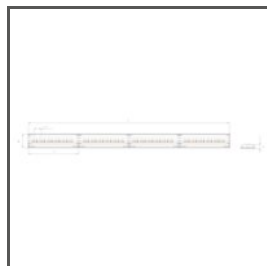

**WP-K-1530-RGB+W-IP65-24V**  
KWP-GRGBW-1530-24  
Ref. arch WP-K-1530RGBWIP6524V



**WP-K-RGB-0700-24V**  
KWP-RGB-0700-24  
Ref. arch WP-K-RGB-0700-24V



**WP-K-RGB-1200-24V**  
KWP-RGB-1200-24  
Ref. arch WP-K-RGB-1200-24V

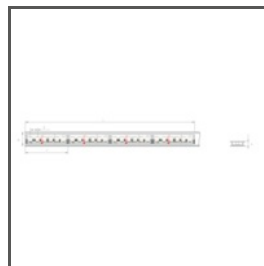

**14K-WP-K-1920-120-RGB-24V**  
KWP-14KHDRGB-1920-24  
Ref. arch 14KWPK1920120RGB24V

RELATED ACCESSORIES > RELATED LED > SIDE EMITTING

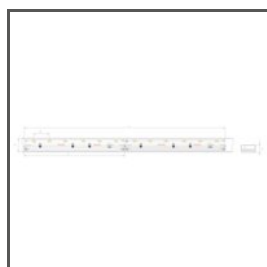

**WP-K-SE-1210-8-24V**  
KWP-SE-1210-24-8  
Ref. arch WP-K-SE-1210-8-24V

RELATED ACCESSORIES > RELATED LED > WHITE MONO



**K-1220-24V**  
K-1220-24  
Ref. arch K-1220-24V

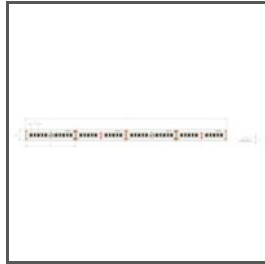

**K-1275-24V**  
K-1275-24  
Ref. arch K-1275-24V



**K-1910-HD-24V**  
K-HD-1910-24  
Ref. arch K-1910-HD-24V

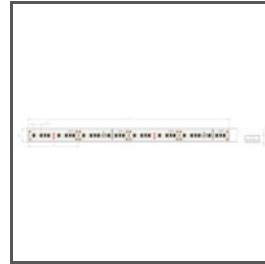

**WP-K-1220-24V**  
KWP-1220-24  
Ref. arch WP-K-1220-24V



**WP-K-1275-24V**  
KWP-1275-24  
Ref. arch WP-K-1275-24V



**WP-K-1910-HD-IP65-24V**  
KWP-GHD-1910-24  
Ref. arch WP-K-1910HDIP6524V



**WP-K-1220-IP65-24V**  
KWP-1220-IP65-24  
Ref. arch WP-K-1220-IP65-24V



**K-0530-HD-24V**  
K-HD-0530-24  
Ref. arch K-0530-HD-24V



**K-2300-24V**  
K-2300-24  
Ref. arch K-2300-24V



**K-0480-24V**  
K-0480-24  
Ref. arch K-0480-24V

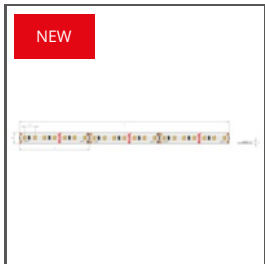

**K-0960-24V**  
K-0960-24  
Ref. arch K-0960-24V

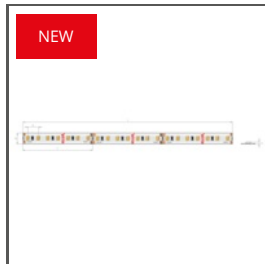

**K-1440-24V**  
K-1440-24  
Ref. arch K-1440-24V



**K-2400-24V**  
K-2400-24

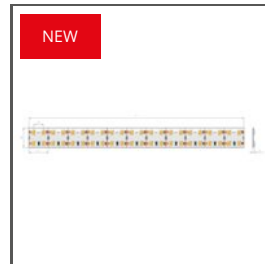

**K2-1920-24V**  
K2-1920-24



**K3-2880-24V**  
K3-2880-24

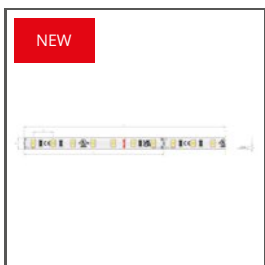

**K-CR-0480-24V**  
K-CR-0480-24



**K-CR-0960-24V**  
K-CR-0960-24



**K-CR-1440-24V**  
K-CR-1440-24



**K-VHE-0480-24V**  
K-VHE-0480-24

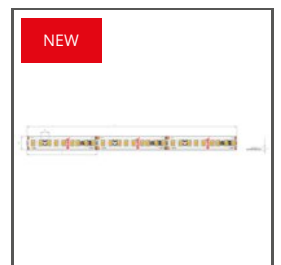

**K-VHE-0960-24V**  
K-VHE-0960-24



**K-VHE-1440-24V**  
K-VHE-1440-24

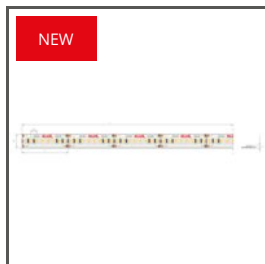

**K-HD-0480-24V**  
K-HD-0480-24



**K-HD-0960-24V**  
K-HD-0960-24



**K-HD-1440-24V**  
K-HD-1440-24



**WP-K-1910-HD-24V**  
KWP-HD-1910-24  
Ref. arch WP-K-1910-HD-24V

# Profile LARKO

Ref. A05552

Ref. arch B5552



**WP-K-1440-24V**  
KWP-1440-24  
Ref. arch WP-K-1440-24V



**WP-K-0480-24V**  
KWP-0480-24  
Ref. arch WP-K-0480-24V

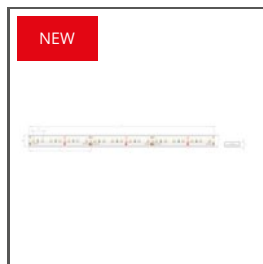

**WP-K-0960-24V**  
KWP-0960-24  
Ref. arch WP-K-0960-24V

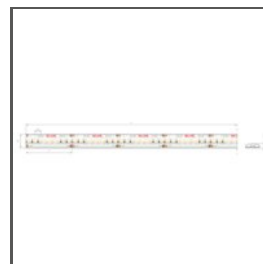

**KWP-GHD-0480-24V**  
KWP-GHD-0480-24

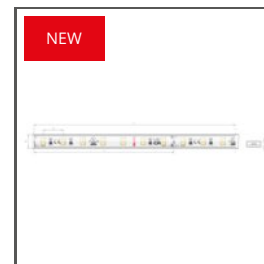

**KWP-CR-0480-24**  
KWP-CR-0480-24



**KWP-CR-0960-24**  
KWP-CR-0960-24

## RELATED ACCESSORIES > OTHER RELATED ACCESSORIES > CONDUCTIVE FASTENERS AND HEADS FOR PROFILES



FASTENER  
**OS22-LIN-Z**  
C28184L07, C28184L10  
Ref. arch 42341L9005, 42341L9010



FASTENER  
**OS22-PRET-Z**  
C28186L07, C28186L10  
Ref. arch 42344L9005, 42344L9010



FASTENER  
**OS22-DUO-LIN-Z**  
C28183L07, C28183L10  
Ref. arch 42340L9005, 42340L9010



FASTENER  
**OS22-DUO-PRET-Z**  
C28185L07, 42343L9010  
Ref. arch 42343L9005, 42343L9010

## RELATED ACCESSORIES > OTHER RELATED ACCESSORIES > CONNECTORS



CONNECTOR  
**ZM-180**  
C28075N00  
Ref. arch 40693



CONNECTOR  
**ZM-NA-60**  
42305

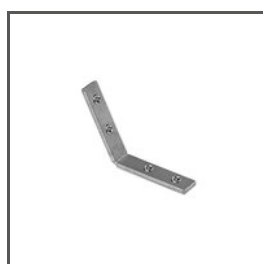

CONNECTOR  
**ZM-NA-PION-120**  
42321

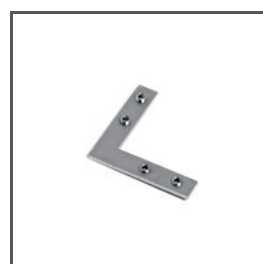

CONNECTOR  
**ZM-NA-90**  
42723



CONNECTOR  
**ZM-NA-PION-135**  
42727

RELATED ACCESSORIES > OTHER RELATED ACCESSORIES > COUPLERS

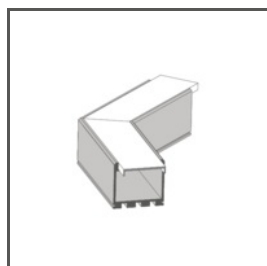

COUPLER  
**L135**  
L135

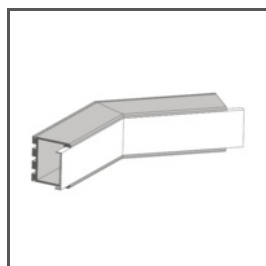

COUPLER  
**L135PW**  
L135PW

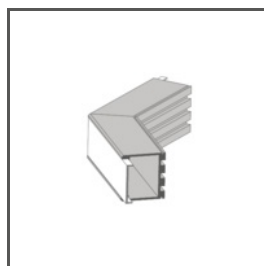

COUPLER  
**L135PZ**  
L135PZ

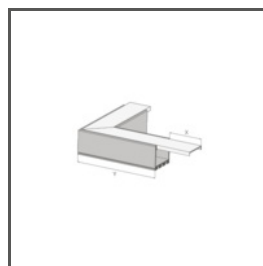

COUPLER  
**L90**  
L90

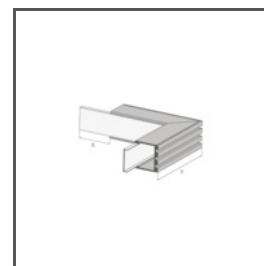

COUPLER  
**L90PW**  
L90PW

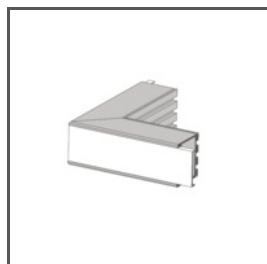

COUPLER  
**L90PZ**  
L90PZ

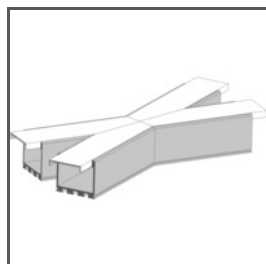

COUPLER  
**X135**  
X135

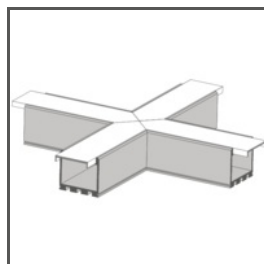

COUPLER  
**X90**  
X90

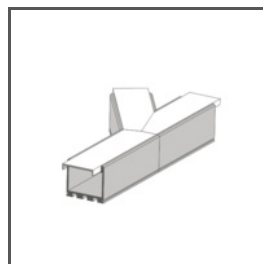

COUPLER  
**T135L**  
T135L

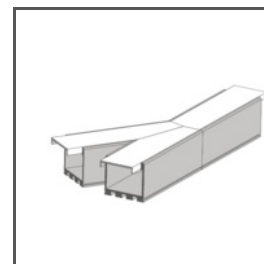

COUPLER  
**T135R**  
T135R

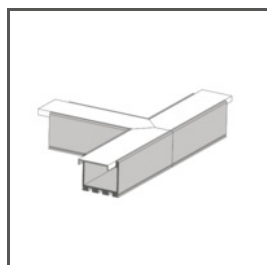

COUPLER  
**T90**  
T90

RELATED ACCESSORIES > OTHER RELATED ACCESSORIES > LATCHES



LATCH  
**TEKNIK**  
C24003C10  
Ref. arch 24003

# Profile LARKO

Ref. A05552

Ref. arch B5552

RELATED ACCESSORIES > OTHER RELATED ACCESSORIES > OTHER



GLAND

**6,4x3**

C42264C07

Ref. arch 42264

RELATED ACCESSORIES > OTHER RELATED ACCESSORIES > PROFILE MASKING COVERS



MASKING COVER

**MP-22**

C28261L01\_0.25,

C28261L10\_0.25,

C28261L07\_0.25

Ref. arch 17167, 17167L9010,  
17167L9005

RELATED ACCESSORIES > OTHER RELATED ACCESSORIES > SPRINGS FOR RECESSED MOUNT AND MOUNTING TRACKS

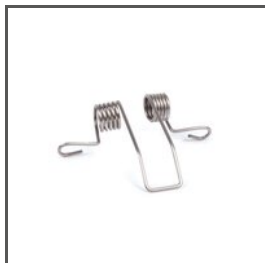

SPRING

**KMA**

C24503N00

Ref. arch 00838



## X-ON Electronics

Largest Supplier of Electrical and Electronic Components

*Click to view similar products for [LED Lighting Mounting Accessories](#) category:*

*Click to view products by [KLUS](#) manufacturer:*

Other Similar products are found below :

[3SU1900-0AC81-0AA0](#) [3SU1900-0AK10-0AA0](#) [3SU1401-2BB40-3AA0](#) [1SFA616921R2142](#) [A4970001](#) [C1900000](#) [C2910001](#) [E4900001S](#)  
[E4990001](#) [C1010000S](#) [F7000101](#) [1-2213678-6](#) [89270019](#) [C7940001](#) [F1000116](#) [A2000138](#) [A2000116](#) [84000139](#) [H5010001](#) [A2000139](#)  
[70330039P020](#) [84000116](#) [70000139](#) [J6999819](#) [V3000139](#) [J6000121](#) [89000138](#) [H5999901](#) [89000639](#) [F1999901](#) [63580000](#) [C1999922](#)  
[76320041S](#) [76000116](#) [J6999902](#) [A00758A07\\_1](#) [AE-WLPR-60P2](#) [PA-GLAX1M-AL-10](#) [A05554A\\_1](#) [C24005C10](#) [PA-ZASGLAXMNKK-00](#)  
[B17013S\\_1](#) [A05556A07\\_1](#) [PA-GLAXMICNK1M-AL](#) [AE-WBCUNI-10DIM](#) [C24338C02](#) [C24427C02TW](#) [C24427C10TW](#) [C24006C02](#)  
[C24346C07](#)