

## Product information

# 92 31 01

## Precision Tweezers



- For particularly demanding precision work: tough and highly resistant to corrosion
- Handcrafted: polished edges and an excellent matt, scratch-free and non-reflective surface
- For the electronics industry, watchmakers, jewellers, laboratories with biological and medical applications in moderately aggressive chemical environments
- High-quality premium stainless steel: high temperature resistance and excellent corrosion resistance to most chemicals, salts and acids
- Ideally suited for microscopic work, precision handling, repairs, manufacturing electronic components, as well as other general applications; tips are guaranteed to have perfect symmetry and balance
- Also available as a set (92 00 02)
- Premium stainless steel

### General

Article No.	92 31 01
EAN	4003773085027
Material	premium stainless steel
Gripping surfaces	smooth gripping surfaces
Weight	14 g
Dimensions	120 x 10 x 11 mm
Reach	no
RohS	no

### Technical details

Tips width (A)	0.09 mm
Tips width (B)	0.16 mm
Corrosion-resistant	yes
	no
VDE tested	no
sectors	Industry electronics

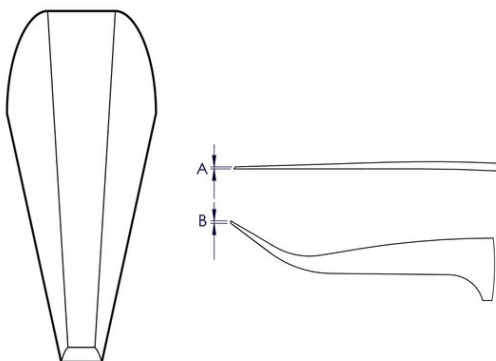

### Classification

eCl@ss 5.1.4	21040500
ETIM 5.0	EC000182
ETIM 6.0	EC000182
proficl@ss 6.0	EAB696c019

technical change and errors excepted



## X-ON Electronics

Largest Supplier of Electrical and Electronic Components

*Click to view similar products for [Knipex manufacturer](#):*

Other Similar products are found below :

[00 11 01](#) [00 11 02](#) [00 11 03](#) [001104](#) [00 11 06](#) [00 11 06 V01](#) [00 11 06 V03](#) [00 11 07](#) [00 19 55 S5](#) [00 19 56](#) [00 19 56 LE](#) [00 19 56 V01](#) [00 19 57](#) [00 19 58 LE](#) [00 19 58 V01](#) [00 19 72 LE](#) [00 19 72 V01](#) [00 20 01 V09](#) [00 20 01 V15](#) [00 20 01 V16](#) [00 20 01 V17](#) [00 20 04 V01](#) [00 20 08 US2](#) [00 20 09 V01](#) [00 20 09 V02](#) [00 20 09 V03](#) [00 20 11](#) [00 20 11 V01](#) [00 20 12](#) [00 20 12 V01](#) [00 20 12 V02](#) [00 20 12 V05](#) [00 20 16](#) [00 20 16 P](#) [00 20 16 P ESD](#) [002017](#) [00 20 18](#) [00 20 18 ESD](#) [00 20 72 V01](#) [00 20 72 V02](#) [00 20 72 V04](#) [00 20 72 V06](#) [00 21 02 EL](#) [00 21 02 LE](#) [00 21 05 LE](#) [00 21 06 HK S](#) [00 21 06 HL S](#) [00 21 06 LE](#) [00 21 08 LE](#) [00 21 10 LE](#)