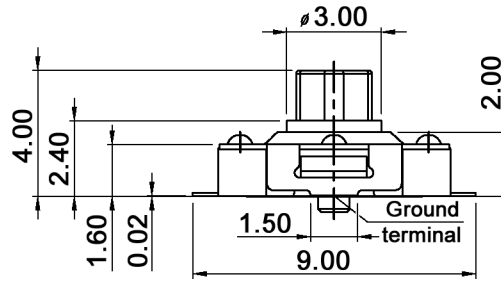
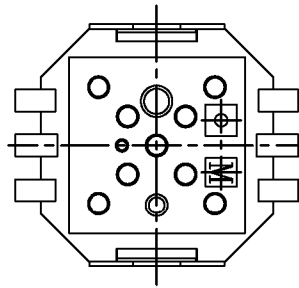
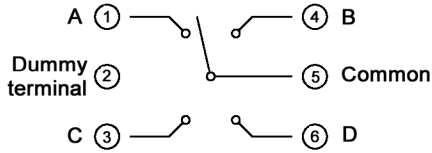
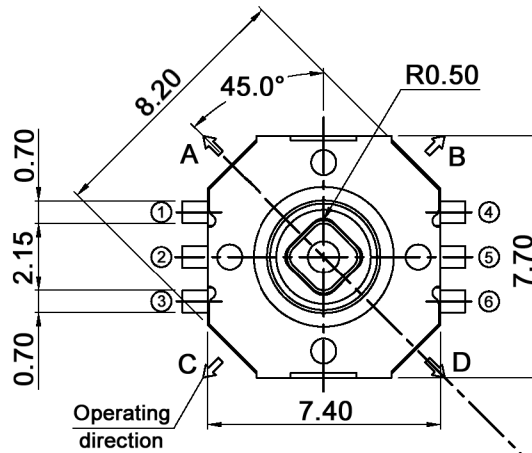
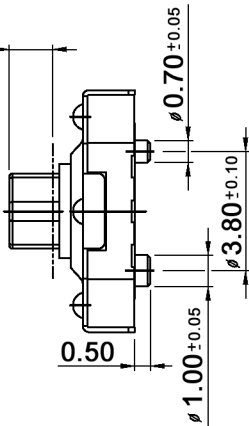

DIAGRAM CIRCUIT



1.40 max.
Fitting margin
for key top



P.C.B. LAYOUT

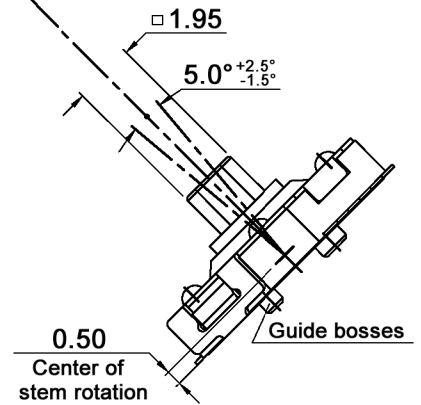
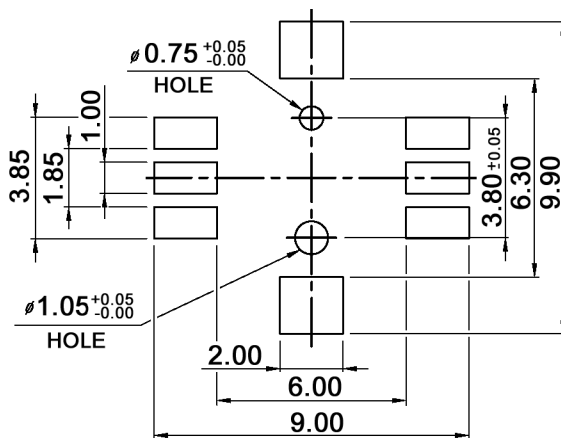

Compliance: RohS II (2011/65/EU)

Tolerances: max. ±0.20mm		Date	Name
		09/05	dr
Cycles	06/17	dr	
Revised	05/16	dr	
Operating temperature	07/15	dr	
Soldering conditions	11/13	dr	
Modifications	Date	Name	

TSSJ 4

knitter-switch

30 06 98

Page

1/2

Specifications:

Contact rating: 50mA, 12V DC
 Contact resistance: 100mOhm max.
 Insulation resistance: 100MOhm min.
 Dielectric strength: 250V AC (50 or 60 Hz) for 1 minute
 Operating temperature: -40°C to +85°C
 Storage temperature: -40°C to +85°C
 Mechanical life: 100 000 cycles min. (per direction)
 Operating force: 160 +/-50gf
 Stroke: 4 directions: 0.25 +0.1/-0.20mm
 Material: Cover: nickel plated
 Stem: high-temp. thermoplastic LCP
 Contact: stainless
 Terminal: brass, silver plated
 Base: high-temp. thermoplastic LCP, molded black

Soldering conditions:

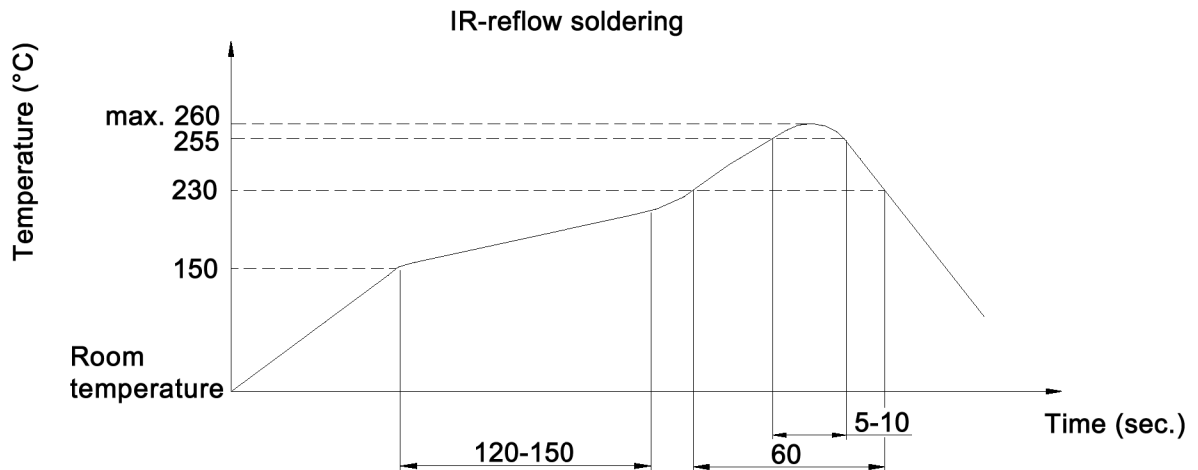

Compliance: RohS II (2011/65/EU)

Tolerances: max. ±0.20mm	Date	Name	TSSJ 4
	09/05	dr	
			30 06 98
			Page
			2/2
Modifications	Date	Name	

X-ON Electronics

Largest Supplier of Electrical and Electronic Components

Click to view similar products for [Tactile Switches](#) category:

Click to view products by [Knitter-Switch](#) manufacturer:

Other Similar products are found below :

[KMR633NG LFG](#) [5GTH9202242](#) [6426-201-11343](#) [MJ1226](#) [MJTP1109B](#) [MJTP1138EAUTR](#) [MJTP1230BL](#) [MJTPSHW](#) [GS6.90F300QP](#) [1-1977223-0](#) [1-1977120-4](#) [ADTSA62NV](#) [ADTSA62RV](#) [ADTSA63KV](#) [ADTSA644NV](#) [ADTSM24NVTR](#) [ADTSMW66NV](#) [ADTSMW67RV](#) [ATM533VTR](#) [1571300-3](#) [B3F-3123](#) [B3F-6055A](#) [B3F-B32-01-KIT](#) [1977177-8](#) [1977266-1](#) [2-1977223-4](#) [2-1977223-7](#) [ADTS644KV](#) [ADTSA61RV](#) [ADTSA62KV](#) [ADTSA63NV](#) [ADTSA63RV](#) [ADTSA65NV](#) [ADTSM21NSVTR](#) [ADTSM25RVTR](#) [ADTSM31RVTR](#) [ADTSM32NVTR](#) [ADTSM61YVTR](#) [ADTSM63SVTR](#) [ADTSM644KVTR](#) [ADTSMW64RV](#) [ADTSMW69NV](#) [FSMRA4JHA04](#) [GS4.70F300QP](#) [D38999/20JJ37SA](#) [TL1105B](#) [TL1105J](#) [ATH447K2Q](#) [ATM534VTR](#) [MJ1215](#)