

AEC-Q200 ***Automotive Grade*** ***Capacitors***

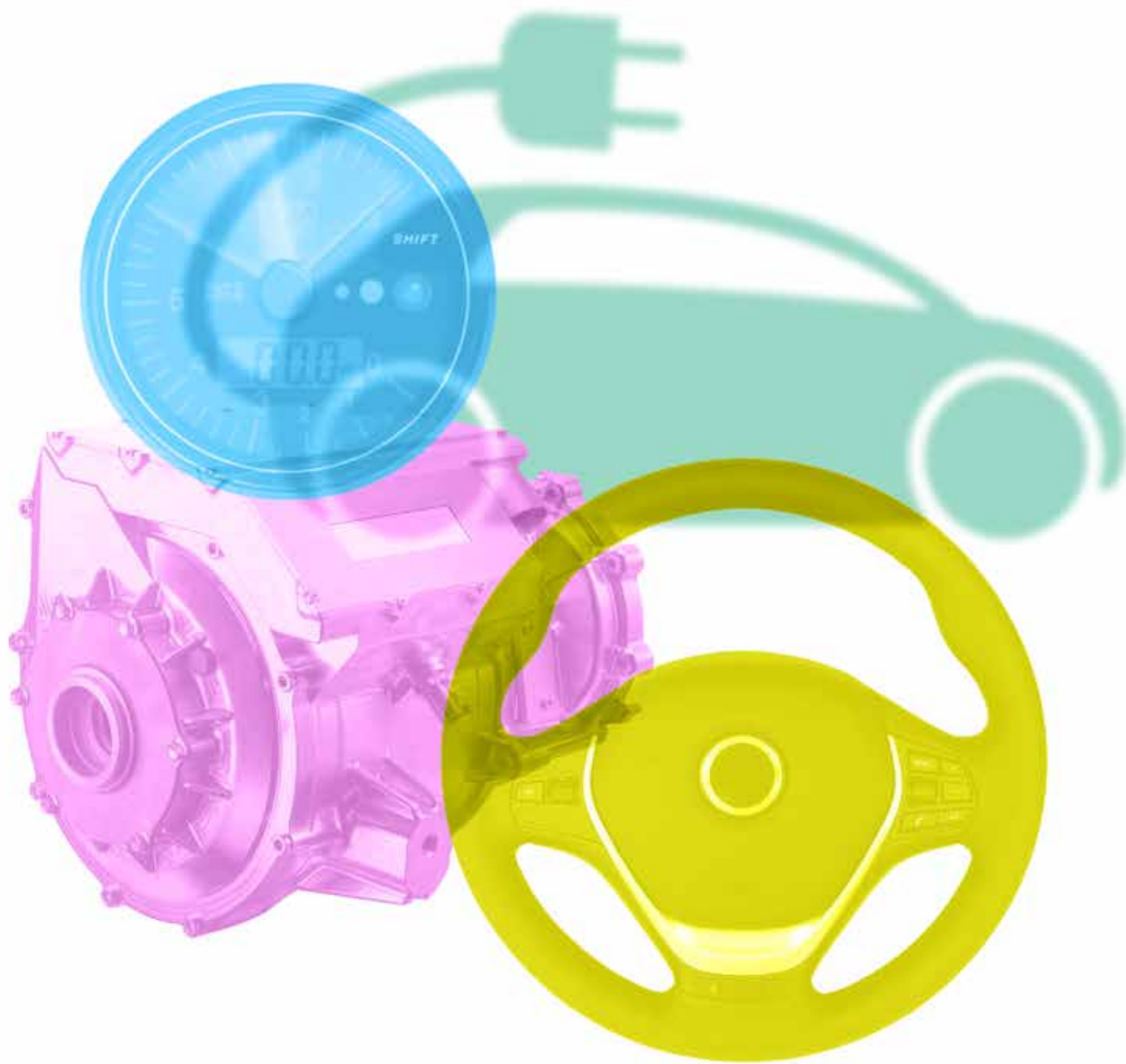

PRECISION DEVICES
knowles

COMPEX • DLI • JOHANSON MFG
NOVACAP • SYFER • VOLTRONICS

AEC-Q200 Automotive Grade Capacitors

At Knowles Precision Devices (KPD) we manufacture Single Layer, Multilayer, High Reliability and Precision Variable Capacitors; EMI Filters and Thin Film Devices.

One of our fields of expertise is the design and manufacture of components important to engineers in the automotive industry. Today's vehicles have many electronic control units that enable absolute precision and control.

The Automotive Electronics Council (AEC) Component Technical Committee is the standardization body for establishing standards for reliable, high quality electronic components. Components meeting these specifications are suitable for use in the harsh automotive environment without additional component-level qualification testing.

The Component Technical Committee established AEC-Q200 "Stress Test Qualification for Passive Components" to define the minimum stress test driven qualification requirements for passive

electrical devices including ceramic capacitors.

KPD's Syfer brand has developed a range of MLC capacitors and surface mount EMI filters qualified to AEC-Q200 rev D to meet the needs of high reliability and automotive manufacturers.

Knowles Suzhou (China), Norwich (England) & Penang (Malaysia) facilities are accredited to IATF 16949:2016 for the design, manufacture and supply of AEC-Q200 qualified MLCC components.

Please refer to the following pages for details of the product ranges offered.

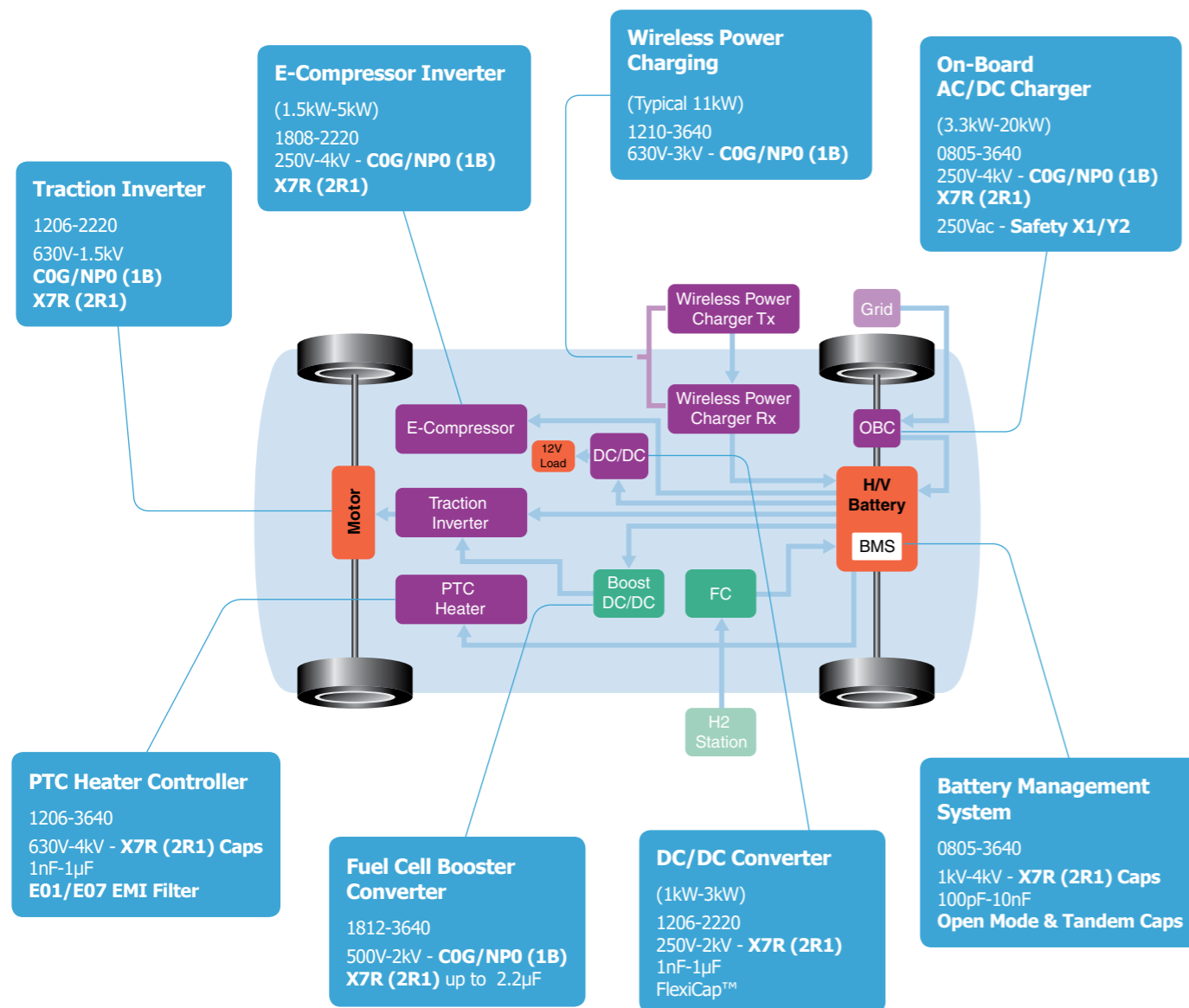

Electric / New Energy Vehicle - BEV/HEV/PHEV/FCV

Contents

| | | |
|--|--|--|
| General & Technical Introduction | Dielectric classifications and characteristics | 4-6 |
| | FlexiCap™ | 7 |
| | IECQ-CECC and AEC-Q200 Periodic Tests | 8 |
| | Manufacturing processes | 9 |
| | Testing | 10 |
| | Regulations and Compliance | 11 |
| | Explanation on Ageing of MLC..... | 12 |
| | Handling, Storage, Soldering and Mechanical Precautions..... | 13-14 |
| | Packaging Information - Ceramic chip capacitors | 15-16 |
| | Chip Dimensions | 17 |
| MLC Capacitors | Automotive Grade - AEC-Q200 ranges - COG/NP0 (1B) | 18-19 |
| | Automotive Grade - AEC-Q200 ranges - X7R (2R1) | 20-21 |
| | Chip Ordering Information | 22 |
| | StackiCap™ - X7R (2R1) | 23 |
| | Safety Certified Capacitors | 24-26 |
| | Open Mode - COG/NP0 (1B) & X7R (2R1) | 27 |
| | Tandem - X7R (2R1) | 28 |
| | High Temperature - X8R - 150°C | 29 |
| | Ultra-low ESR HiQ MLCCs - X8G range | 30-31 |
| | SM EMI Filters | Surface Mount EMI Filters - E01 & E07..... |
| X2Y Integrated Passive Components - E03..... | | 34-35 |

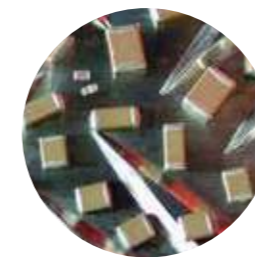

AEC-Q200 approved ranges - pages 18-21



StackiCap™ Capacitors - page 23

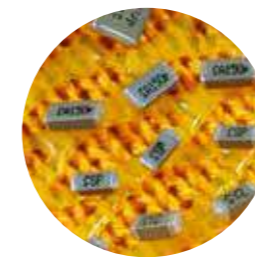

Safety Certified Capacitors - pages 24-26

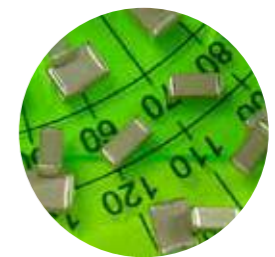

Open Mode & Tandem Capacitors - pages 27-28

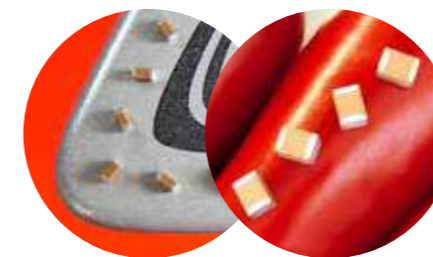

High Temperature Capacitors - pages 29-31

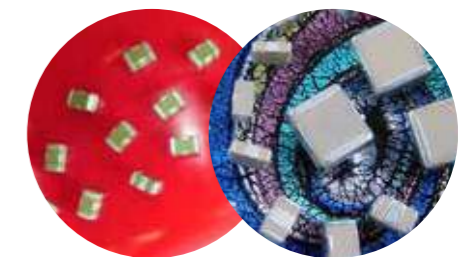

Surface Mount EMI Filters - pages 32-35

Dielectric characteristics

Class I Dielectrics

Multilayer Ceramic Capacitors are generally divided into classes which are defined by the capacitance temperature characteristics over specified temperature ranges. These are designated by alpha numeric codes. Code definitions are summarised below and are also available in the relevant national and international specifications.

Capacitors within this class have a dielectric constant range from 10 to 100. They are used in applications which require ultra stable

dielectric characteristics with negligible dependence of capacitance and dissipation factor with time, voltage and frequency. They exhibit the following characteristics:-

- a) Time does not significantly affect capacitance and dissipation factor (Tan δ) – no ageing.
- b) Capacitance and dissipation factor are not affected by voltage.
- c) Linear temperature coefficient.

| | | Class I Dielectrics | | | | | | |
|--|--------------------------|---|--------------------|--|--|---|-----------------------------|-------------------------|
| | | COG/ NPO (1B) (Porcelain) | P90 (Porcelain) | COG/NPO (1B) | | X8G | Class I High Temperature | |
| | | Ultra stable | Ultra stable | Ultra stable | | Ultra stable | Ultra stable | |
| Dielectric classifications | IECQ-CECC | - | - | 1B/CG | | - | - | - |
| | EIA | COG/NPO (1B) | P90 | COG/NPO (1B) | | X8G | - | - |
| | MIL | - | - | CG (BP) | | - | - | - |
| Ordering code | DLI | CF | AH | - | - | - | - | - |
| | Novacap | - | - | - | N, RN | - | F | D, RD |
| | Syfer | - | - | Q, U | C | H | - | G |
| | Voltronics | F | H | Q | - | - | - | - |
| Rated temperature range | | -55°C to +125°C | -55°C to +125°C | -55°C to +125°C | -55°C to +125°C | -55°C to +150°C | -55°C to +160°C | -55°C to +200°C |
| Maximum capacitance change over temperature range | No DC voltage applied | 0 ±15 ppm/°C | 0 ±20 ppm/°C | 0 ±30 ppm/°C | 0 ±30 ppm/°C | 0 ±30 ppm/°C | 0 ±30 ppm/°C | 0 ±30 ppm/°C |
| | Rated DC voltage applied | - | | | | | | |
| Tangent of loss angle (tan δ) | | ≤0.0005 @1MHz | | ≤0.0005 @1MHz | >50pF ≤0.0015 ≤50pF 0.0015 (15 + 0.7) Cr | ≤0.0005 @1MHz | ≤0.001 | |
| Insulation resistance (Ri) | Time constant (Ri x Cr) | @25°C = 10 ⁶ MΩ min @125°C = 10 ⁵ MΩ min | | 100GΩ or 1000s (whichever is the least) | | @25°C = 100GΩ or 1000ΩF @160°C & 200°C = 1GΩ or 10ΩF (whichever is the least) | | Time constant (Ri x Cr) |
| Capacitance Tolerance | Cr <4.7pF | ±0.05pF, ±0.10pF, ±0.25pF, ±0.5pF | | | | | | |
| | Cr ≥4.7 to <10pF | ±0.10pF, ±0.25pF, ±0.5pF | | | | | | |
| | Cr ≥10pF | ±1%, ±2%, ±5%, ±10% | | | | | | |
| Dielectric strength Voltage applied for 5 seconds. Charging current limited to 50mA maximum. | ≤200V | 2.5 times | | 2.5 times | | | | |
| | >200V to <500V | | | Rated voltage +250V | | | | |
| | 500V to ≤1kV | | | 1.5 times | | | | |
| | >1kV to ≤1.2kV | | | 1.25 times | | | | |
| | >1.2kV | | | 1.2 times | | | | |
| Climatic category (IEC) | Chip | - | - | 55/125/56 | | - | - | Chip |
| | Dipped | - | - | - | 55/125/21 | - | - | Dipped |
| | Discoidal | - | - | - | 55/125/56 | - | - | Discoidal |
| Ageing characteristic (Typical) | | Zero | | | | | | |
| Approvals | Syfer Chip | - | - | - | QC-32100 | - | - | - |

Dielectric characteristics

Class II Dielectrics

Capacitors of this type have a dielectric constant range of 1000-4000 and also have a non-linear temperature characteristic which exhibits a dielectric constant variation of less than ±15% (2R1) from its room temperature value, over the specified temperature range. Generally used for by-passing (decoupling), coupling, filtering, frequency discrimination, DC blocking and voltage transient suppression with greater volumetric efficiency than Class I units, whilst maintaining stability within defined limits.

Capacitance and dissipation factor are affected by:-

- a) Time (Ageing)
- b) Voltage (AC or DC)
- c) Frequency

| | | Class II Dielectrics | | | | | | |
|--|--------------------------|--|----------------------------|---------------------|----------|-----------------|------------------------------|-------------------------|
| | | X5R | X7R (2R1) | | | X8R | Class II High Temperature | |
| | | Stable | Stable | | | Stable | Stable | |
| Dielectric classifications | IECQ-CECC | - | 2C1 | 2R1 | 2X1 | - | - | - |
| | EIA | X5R | - | X7R (2R1) | | - | X8R | - |
| | MIL | - | BZ | - | BX | - | - | - |
| Ordering code | DLI | - | - | - | - | - | - | - |
| | Novacap | BW | - | B, RB | X | S | G | E, RE |
| | Syfer | P | R | X | B | N | - | X |
| | Voltronics | - | - | X | - | - | - | - |
| Rated temperature range | | -55°C to +85°C | -55°C to +125°C | | | -55°C to +150°C | -55°C to +160°C | -55°C to +200°C |
| Maximum capacitance change over temperature range | No DC voltage applied | ±15% | ±15% | ±15% | ±15% | ±15% | +15 -40% | +15 -65% |
| | Rated DC voltage applied | - | +15 -45% | - | +15 -25% | - | - | - |
| Tangent of loss angle (tan δ) | | ≤ 0.025 Typical* | >25V ≤0.025 ≤25V ≤0.035 | | | ≤0.025 | ≤0.025 | |
| Insulation resistance (Ri) | Time constant (Ri x Cr) | 100GΩ or 1000s (whichever is the least) | | | | | | Time constant (Ri x Cr) |
| Capacitance Tolerance | Cr <4.7pF | ±0.05pF, ±0.10pF, ±0.25pF, ±0.5pF | | | | | | |
| | Cr ≥4.7 to <10pF | ±0.10pF, ±0.25pF, ±0.5pF | | | | | | |
| | Cr ≥10pF | ±1%, ±2%, ±5%, ±10% | | | | | | |
| Dielectric strength Voltage applied for 5 seconds. Charging current limited to 50mA maximum. | ≤200V | 2.5 times | | 2.5 times | | | | |
| | >200V to <500V | | | Rated voltage +250V | | | | |
| | 500V to <1kV | | | 1.5 times | | | | |
| | >1kV to ≤1.2kV | | | 1.25 times | | | | |
| | >1.2kV | | | 1.2 times | | | | |
| Climatic category (IEC) | Chip | 55/85/56 | 55/125/56 | | | 55/150/56 | - | Chip |
| | Dipped | - | 55/125/21 | | | - | - | Dipped |
| | Discoidal | - | 55/125/56 | | | - | - | Discoidal |
| Ageing characteristic (Typical) | | 5% Typical | | | | | | <2% per time decade |
| Approvals | Syfer Chip | - | QC-32100 | - | - | - | QC-32100 | - |

* Refer to the MLC Capacitors catalogue for details of Dissipation Factor.

Dielectric characteristics

Typical dielectric temperature characteristics

Porcelain COG/NP0 (1B) & P90

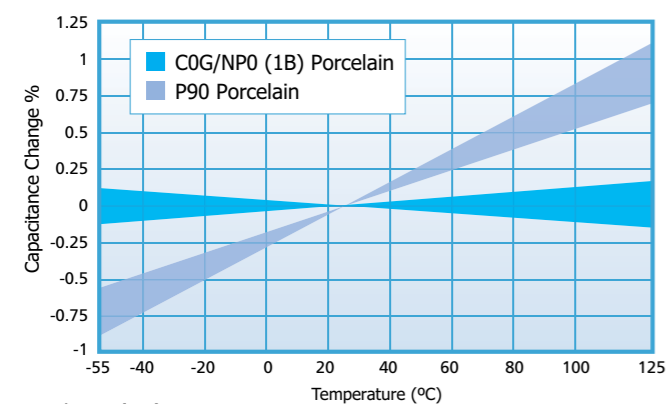

COG/NP0 (1B)

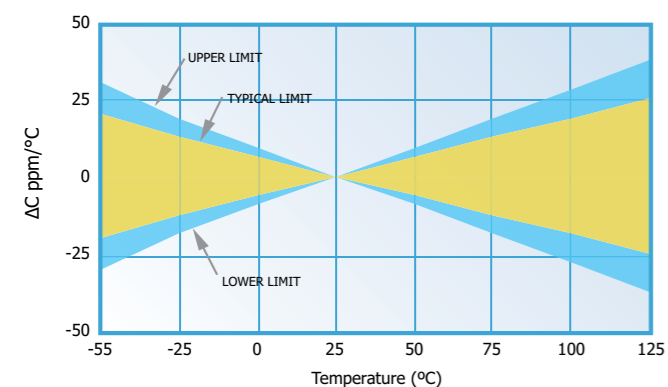

X7R (2R1)

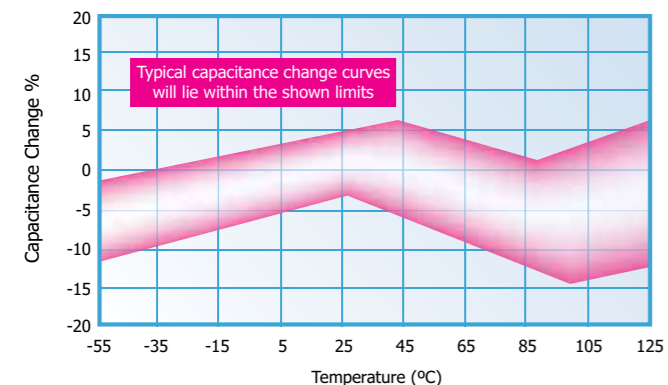

Impedance vs Frequency

Ultra Stable COG/NP0 (1B) dielectric

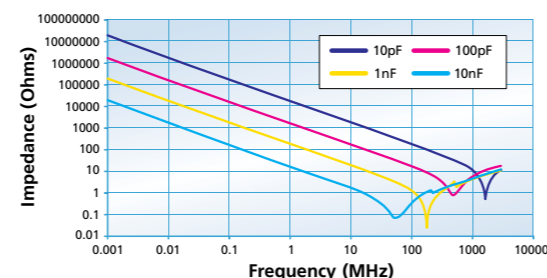

Stable X7R (2R1) dielectric

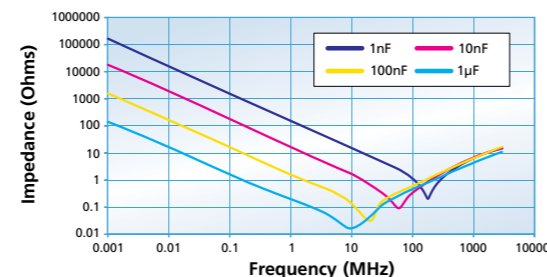

Stable X7R (2R1) dielectric - 10nF

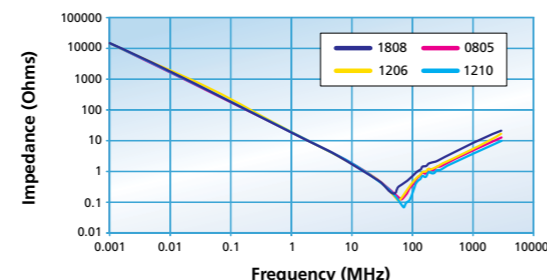

ESR vs Frequency - chips

Ultra Stable COG/NP0 (1B) dielectric

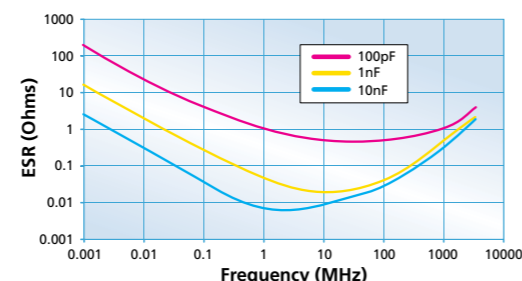

Stable X7R (2R1) dielectric

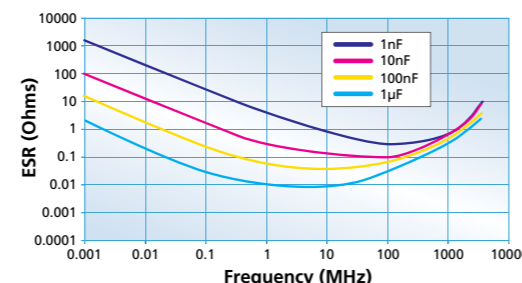

FlexiCap™ overview

FlexiCap™ termination

MLCCs are widely used in electronic circuit design for a multitude of applications. Their small package size, technical performance and suitability for automated assembly makes them the component of choice for the specifier.

However, despite the technical benefits, ceramic components are brittle and need careful handling on the production floor. In some circumstances they may be prone to mechanical stress damage if not used in an appropriate manner. Board flexing, depanelisation, mounting through hole components, poor storage and automatic testing may all result in cracking.

Careful process control is important at all stages of circuit board assembly and transportation - from component placement to test and packaging. Any significant board flexing may result in stress fractures in ceramic devices that may not always be evident during the board assembly process. Sometimes it may be the end customer who finds out - when equipment fails!

Knowles has the solution - FlexiCap™

FlexiCap™ has been developed as a result of listening to customers' experiences of stress damage to MLCCs from many manufacturers, often caused by variations in production processes.

Our answer is a proprietary flexible epoxy polymer termination material, that is applied to the device under the usual nickel barrier finish. FlexiCap™ will accommodate a greater degree of board bending than conventional capacitors.

Knowles FlexiCap™ termination

Ranges are available with FlexiCap™ termination material offering increased reliability and superior mechanical performance (board flex and temperature cycling) when compared with standard termination materials. Refer to Knowles application note reference AN0001. FlexiCap™ capacitors enable the board to be bent almost twice as much before mechanical cracking occurs. Refer to application note AN0002.

FlexiCap™ is also suitable for Space applications having passed thermal vacuum outgassing tests. Refer to Syfer application note reference AN0026.

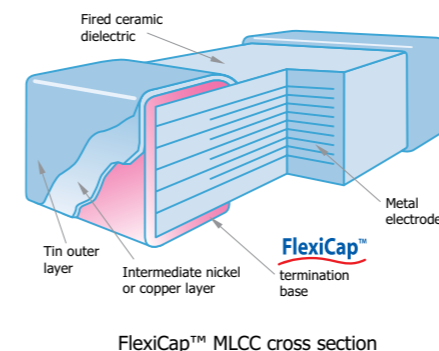

FlexiCap™ benefits

With traditional termination materials and assembly, the chain of materials from bare PCB to soldered termination, provides no flexibility. In circumstances where excessive stress is applied - the weakest link fails. This means the ceramic itself, which may fail short circuit.

The benefit to the user is to facilitate a wider process window - giving a greater safety margin and substantially reducing the typical root causes of mechanical stress cracking.

FlexiCap™ may be soldered using your traditional wave or reflow solder techniques including lead free and needs no adjustment to equipment or current processes.

Knowles has delivered millions of FlexiCap™ components and during that time has collected substantial test and reliability data,

working in partnership with customers world wide, to eliminate mechanical cracking.

An additional benefit of FlexiCap™ is that MLCCs can withstand temperature cycling -55°C to 125°C in excess of 1,000 times without cracking.

FlexiCap™ termination has no adverse effect on any electrical parameters, nor affects the operation of the MLCC in any way.

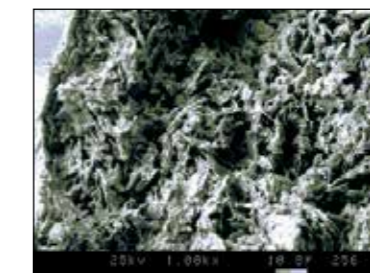

Picture taken at 1,000x magnification using a SEM to demonstrate the fibrous nature of the FlexiCap™ termination that absorbs increased levels of mechanical stress.

Available on the following ranges:

- All High Reliability ranges
- Standard and High Voltage Capacitors
- Open Mode and Tandem Capacitors
- Safety Certified Capacitors
- Non-magnetic Capacitors
- 3 terminal EMI chips
- X2Y Integrated Passive Components
- X8R High Temperature capacitors

Summary of PCB bend test results

The bend tests conducted on X7R (2R1) have proven that the FlexiCap™ termination withstands a greater level of mechanical stress before mechanical cracking occurs.

The AEC-Q200 test for X7R (2R1) requires a bend level of 2mm minimum and a cap change of less than 10%.

| Product X7R (2R1) | Typical bend performance under AEC-Q200 test conditions |
|----------------------|---|
| Standard termination | 2mm to 3mm |
| FlexiCap™ | Typically 8mm to 10mm |

Application notes

FlexiCap™ may be handled, stored and transported in the same manner as standard terminated capacitors. The requirements for mounting and soldering FlexiCap™ are the same as for standard SMD capacitors.

For customers currently using standard terminated capacitors there should be no requirement to change the assembly process when converting to FlexiCap™.

Based upon board bend tests in accordance with IEC 60384-1 the amount of board bending required to mechanically crack a FlexiCap™ terminated capacitor is significantly increased compared with standard terminated capacitors.

It must be stressed however, that capacitor users must not assume that the use of FlexiCap™ terminated capacitors will totally eliminate mechanical cracking. Good process controls are still required for this objective to be achieved.



Periodic tests conducted for IECQ-CECC and AEC-Q200

| Test ref | Test | Termination type | Additional requirements | Sample acceptance | | | Reference |
|----------|---|---|--|-------------------|----|---|---------------------------------------|
| | | | | P | N | C | |
| P1 | High temperature exposure (storage) | All types | Un-powered. 1,000 hours @ T=150°C. Measurement at 24 ± 2 hours after test conclusion | 12 | 77 | 0 | MIL-STD-202 Method 108 |
| P2 | Temperature cycling | COG/NP0 (1B): All types X7R (2R1): Y and H only | 1,000 cycles -55°C to +125°C. Measurement at 24 ± 2 hours after test conclusion | 12 | 77 | 0 | JESD22 Method JA-104 |
| P3 | Moisture resistance | All types | T = 24 hours/cycle. Note: Steps 7a and 7b not required. Un-powered. Measurement at 24 ± 2 hours after test conclusion | 12 | 77 | 0 | MIL-STD-202 Method 106 |
| P4 | Biased humidity | All types | 1,000 hours 85°C/85%RH. Rated voltage or 50V whichever is the least and 1.5V. Measurement at 24 ± 2 hours after test conclusion | 12 | 77 | 0 | MIL-STD-202 Method 103 |
| P5 | Operational life | All types | Condition D steady state TA=125°C at full rated. Measurement at 24 ± 2 hours after test conclusion | 12 | 77 | 0 | MIL-STD-202 Method 108 |
| P6 | Resistance to solvents | All types | Note: Add aqueous wash chemical. Do not use banned solvents | 12 | 5 | 0 | MIL-STD-202 Method 215 |
| P7 | Mechanical shock | COG/NP0 (1B): All types X7R (2R1): Y and H only | Figure 1 of Method 213. Condition F | 12 | 30 | 0 | MIL-STD-202 Method 213 |
| P8 | Vibration | COG/NP0 (1B): All types X7R (2R1): Y and H only | 5g's for 20 minutes, 12 cycles each of 3 orientations. Note: Use 8" x 5" PCB 0.031" thick 7 secure points on one long side and 2 secure points at corners of opposite sides. Parts mounted within 2" from any secure point. Test from 10-2,000Hz | 12 | 30 | 0 | MIL-STD-202 Method 204 |
| P9 | Resistance to soldering heat | All types | Condition B, no pre-heat of samples: Single wave solder - Procedure 2 | 3 | 12 | 0 | MIL-STD-202 Method 210 |
| P10 | Thermal shock | COG/NP0 (1B): All types X7R (2R1): Y and H only | -55°C/+125°C. Number of cycles 300. Maximum transfer time - 20 seconds, dwell time - 15 minutes. Air-Air | 12 | 30 | 0 | MIL-STD-202 Method 107 |
| P11 | Adhesion, rapid temp change and climatic sequence | X7R (2R1): A, F and J only | 5N force applied for 10s, -55°C/ +125°C for 5 cycles, damp heat cycles | 12 | 27 | 0 | BS EN132100 Clause 4.8, 4.12 and 4.13 |
| P12 | Board flex | COG/NP0 (1B): All types X7R (2R1): Y and H only | 3mm deflection Class I 2mm deflection Class II | 12 | 30 | 0 | AEC-Q200-005 |
| P13 | Board flex | X7R (2R1): A, F and J only | 1mm deflection. | 12 | 12 | 0 | BS EN132100 Clause 4.9 |
| P14 | Terminal strength | All types | Force of 1.8kg for 60 seconds | 12 | 30 | 0 | AEC-Q200-006 |
| P15 | Beam load test | All types | - | 12 | 30 | 0 | AEC-Q200-003 |
| P16 | Damp heat steady state | All types | 56 days, 40°C / 93% RH 15x no volts, 15x 5Vdc, 15x rated voltage or 50V whichever is the least. | 12 | 45 | 0 | BS EN132100 Clause 4.14 |

Test results are available on request.
 P = Period in months.
 N = Sample size.
 C = Acceptance criteria.

Production process flowchart

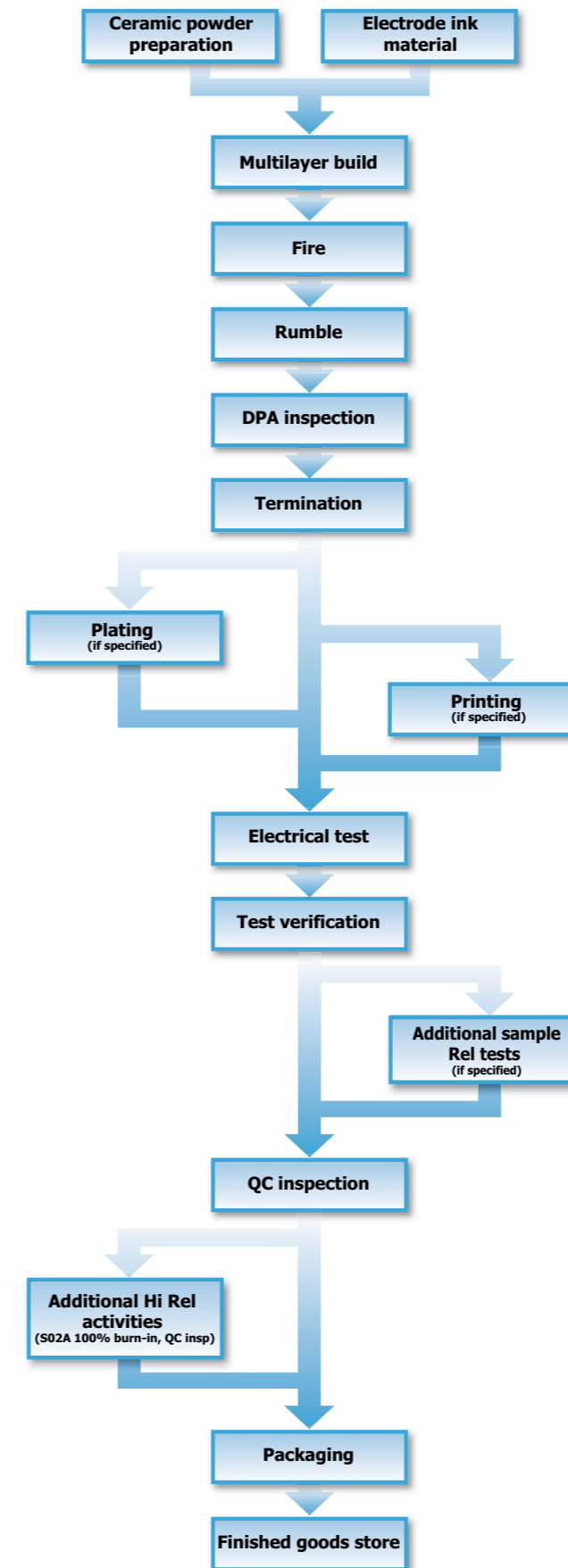

Knowles reliability grades

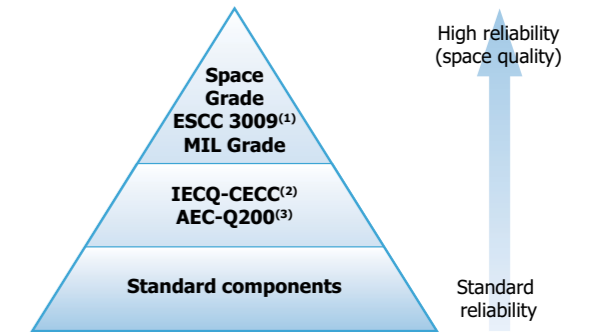

Notes:

- 1) Space grade tested in accordance with ESCC3009 (refer to Knowles Spec S02A 0100) or MIL Grade (in accordance with MIL-PRF-123, MIL-PRF-55681).
- 2) IECQ-CECC. The International Electrotechnical Commission (IEC) Quality Assessment System for Electronic Components. This is an internationally recognised product quality certification which provides customers with assurance that the product supplied meets high quality standards. View Knowles IECQ-CECC approvals at <http://www.iecq.org> or at www.knowlescapers.com
- 3) AEC-Q200. Automotive Electronics Council Stress Test Qualification For Passive Components. Refer to Knowles application note reference AN0009.

Knowles reliability surface mount product groups

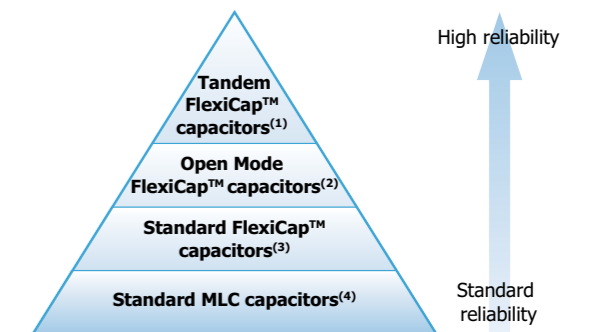

Notes:

- 1) "Tandem" construction capacitors, ie internally having the equivalent of 2 series capacitors. If one of these should fail short-circuit, there is still capacitance end to end and the chip will still function as a capacitor, although capacitance may be affected. Refer to application note AN0021. Also available qualified to AEC-Q200.
- 2) "Open Mode" capacitors with FlexiCap™ termination also reduce the possibility of a short circuit by utilising inset electrode margins. Refer to application note AN0022. Also available qualified to AEC-Q200.
- 3) Multilayer capacitors with Knowles FlexiCap™ termination. By using FlexiCap™ termination, there is a reduced possibility of the mechanical cracking occurring.
- 4) "Standard" capacitors includes MLCCs with tin finish over nickel but no FlexiCap™.

Testing

Tests conducted during batch manufacture

| | Knowles reliability SM product group | | | |
|--|--------------------------------------|-----------------------|----------|---|
| | Standard SM capacitors | IECQ-CECC / MIL grade | AEC-Q200 | S (Space grade) High Rel S02A ESCC 3009 MIL-PRF-123 |
| Solderability | ● | ● | ● | ● |
| Resistance to soldering heat | ● | ● | ● | ● |
| Plating thickness verification (if plated) | ● | ● | ● | ● |
| DPA (Destructive Physical Analysis) | ● | ● | ● | ● |
| Voltage proof test (DWV / Flash) | ● | ● | ● | ● |
| Insulation resistance | ● | ● | ● | ● |
| Capacitance test | ● | ● | ● | ● |
| Dissipation factor test | ● | ● | ● | ● |
| 100% visual inspection | ○ | ○ | ● | ● |
| 100% burn-in. (2xRV @125°C for 168 hours) | ○ | ○ | ○ | ● |
| Load sample test @ 125°C | ○ | ○ | ● | LAT1 & LAT2 (1000 hours) |
| Humidity sample test. 85°C/85%RH | ○ | ○ | ● | 240 hours |
| Hot IR sample test | ○ | ○ | ○ | ○ |
| Axial pull sample test (MIL-STD-123) | ○ | ○ | ○ | ○ |
| Breakdown voltage sample test | ○ | ○ | ○ | ○ |
| Deflection (bend) sample test | ○ | ○ | ○ | ○ |
| SAM (Scanning Acoustic Microscopy) | ○ | ○ | ○ | ○ |
| LAT1 (4 x adhesion, 8 x rapid temp change + LAT2 and LAT3) | - | - | - | ○ |
| LAT2 (20 x 1000 hour life test + LAT3) | - | - | - | ○ |
| LAT3 (6 x TC and 4 x solderability) | - | - | - | ○ |

- Test conducted as standard.
- Optional test. Please discuss with the Sales Office.

Regulations and Compliance

Release documentation

| | Knowles Precision Devices reliability SM product group | | | |
|---|--|-----------|--------------------|-------------------------------|
| | Standard SM capacitors | IECQ-CECC | AEC-Q200 MIL grade | S (Space grade) High Rel S02A |
| Certificate of conformance | ● | - | ● | ● |
| IECQ-CECC Release certificate of conformity | - | ● | - | - |
| Batch electrical test report | ○ | ○ | ○ | Included in data pack |
| S (space grade) data documentation package | - | - | - | ● |

- Release documentation supplied as standard.
- Original documentation.

Periodic tests conducted and reliability data availability

Standard Surface Mount capacitors

Components are randomly selected on a sample basis and the following routine tests are conducted:

- Load Test. 1,000 hours @125°C (150°C for X8R). Applied voltage depends on components tested.
- Humidity Test. 168 hours @ 85°C/85%RH.
- Board Deflection (bend test).

Test results are available on request.

Conversion factors

| From | To | Operation |
|------|--------------|---------------------------------------|
| FITS | MTBF (hours) | $10^9 \div \text{FITS}$ |
| FITS | MTBF (years) | $10^9 \div (\text{FITS} \times 8760)$ |

FITS = Failures in 10^9 hours.
MTBF = Mean time between failures.

REACH (Registration, Evaluation, Authorisation and restriction of Chemicals) statement

The main purpose of REACH is to improve the protection of human health and the environment from the risks arising from the use of chemicals.

Knowles maintains both ISO14001, Environmental Management System and OHSAS 18001 Health and Safety Management System approvals that require and ensure compliance with corresponding legislation such as REACH.

For further information, please contact the Knowles Precision Devices Sales Office at www.knowlescapacitors.com

RoHS compliance

Knowles routinely monitors world wide material restrictions (e.g. EU/China and Korea RoHS mandates) and is actively involved in shaping future legislation.

All standard COG/NP0 (1B), X7R (2R1), X5R, X8R, X8G and High Q Knowles MLCC products are 100% lead free and compliant with the

Export controls and dual-use regulations

Certain Knowles catalogue components are defined as 'dual-use' items under international export controls - those that can be used for civil or military purposes which meet certain specified technical standards.

The defining criteria for a dual use component with respect to Knowles capacitor products is one with a voltage rating of >750Vdc

Example of FIT (Failure In Time) data available:

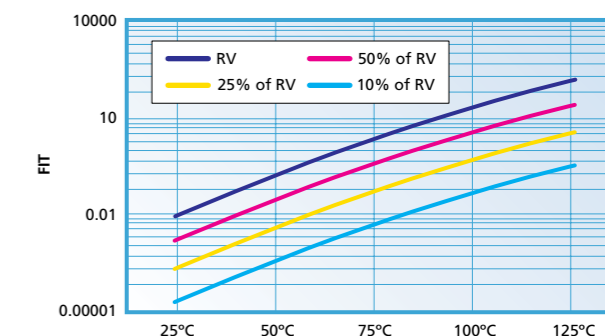

Component type: 0805 (COG/NP0 (1B) and X7R (2R1)).
Testing location: Knowles PD reliability test department.
Results based on: 16,622,000 component test hours.

EU RoHS directive. Those with plated terminations are suitable for soldering using common lead free solder alloys (refer to 'Soldering Information' for more details on soldering limitations). Compliance with the EU RoHS directive automatically signifies compliance with some other legislation (e.g. China and Korea RoHS). Please refer to the Knowles Precision Devices Sales Office for details of compliance with other materials legislation.

Breakdown of material content, SGS analysis reports and tin whisker test results are available on request.

Most Knowles PD MLCC components are available with non RoHS compliant tin lead (SnPb) solderable termination finish for exempt applications and where pure tin is not acceptable. Other tin free termination finishes may also be available – please refer to the Knowles Precision Devices Sales Office for further details.

Environmental certificates can be downloaded from the Knowles Precision Devices website.



and a capacitance value of >250nF when measured at 750Vdc and a series inductance <10nH. Components defined as dual-use under the above criteria may require a licence for export across international borders. Please contact the Sales Office for further information on specific part numbers.

Explanation of Ageing of MLC

Ageing

Capacitor ageing is a term used to describe the negative, logarithmic capacitance change which takes place in ceramic capacitors with time. The crystalline structure for barium titanate based ceramics changes on passing through its Curie temperature (known as the Curie Point) at about 125°C. This domain structure relaxes with time and in doing so, the dielectric constant reduces logarithmically; this is known as the ageing mechanism of the dielectric constant. The more stable dielectrics have the lowest ageing rates.

The ageing process is reversible and repeatable. Whenever the capacitor is heated to a temperature above the Curie Point the ageing process starts again from zero.

The ageing constant, or ageing rate, is defined as the percentage loss of capacitance due to the ageing process of the dielectric which occurs during a decade of time (a tenfold increase in age) and is expressed as percent per logarithmic decade of hours. As the law of decrease of capacitance is logarithmic, this means that in a capacitor with an ageing rate of 1% per decade of time, the capacitance will decrease at a rate of:

- 1% between 1 and 10 hours
- An additional 1% between the following 10 and 100 hours
- An additional 1% between the following 100 and 1000 hours
- An additional 1% between the following 1000 and 10000 hours etc
- The ageing rate continues in this manner throughout the capacitor's life.

Typical values of the ageing constant for our Multilayer Ceramic Capacitors are:

| Dielectric class | Typical values |
|---------------------------|--|
| Ultra Stable COG/NP0 (1B) | Negligible capacitance loss through ageing |
| Stable X7R (2R1) | <2% per decade of time |

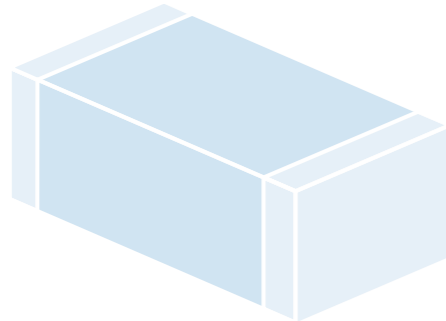

Capacitance measurements

Because of ageing it is necessary to specify an age for reference measurements at which the capacitance shall be within the prescribed tolerance. This is fixed at 1000 hours, since for practical purposes there is not much further loss of capacitance after this time.

All capacitors shipped are within their specified tolerance at the standard reference age of 1000 hours after having cooled through their Curie temperature.

The ageing curve for any ceramic dielectric is a straight line when plotted on semi-log paper.

Capacitance vs time

(Ageing X7R (2R1) @ <2% per decade)

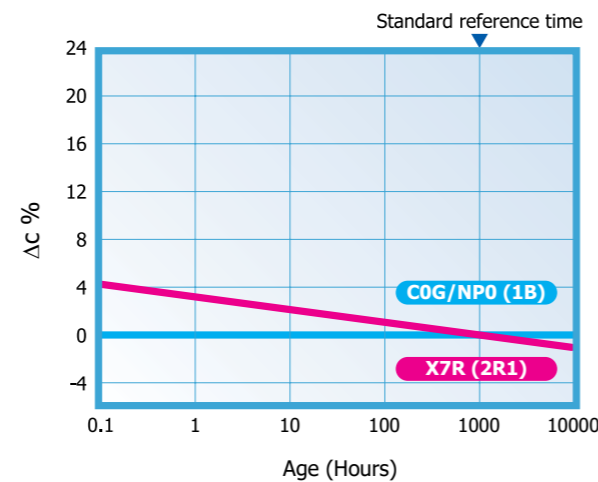

Tight tolerance

One of the advantages of Knowles' unique 'wet process' of manufacture is the ability to offer capacitors with exceptionally tight capacitance tolerances.

The accuracy of the printing screens used in the fully automated, computer controlled manufacturing process allows for tolerance as close as +/-1% on COG/NP0 (1B) parts greater than or equal to 10pF. For capacitance values below <4.7pF, tolerances can be as tight as +/-0.05pF.

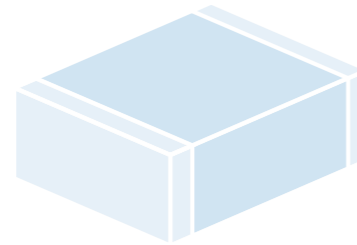

Mounting, Soldering, Storage & Mechanical Precautions

Knowles Precision Devices (KPD) MLCCs are compatible with all recognised soldering / mounting methods for chip capacitors.

Mechanical considerations for mounting MLCCs

Due to their brittle nature, ceramic chip capacitors are more prone to excesses of mechanical stress than other components used in surface mounting.

One of the most common causes of failure is directly attributable to bending the printed circuit board after solder attachment. The excessive or sudden movement of the flexible circuit board stresses the inflexible ceramic block causing a crack to appear at the weakest point, usually the ceramic/termination interface. The crack may initially be quite small and not penetrate into the inner electrodes; however, subsequent handling and rapid changes in temperature may cause the crack to enlarge.

This mode of failure is often invisible to normal inspection techniques as the resultant cracks usually lie under the capacitor terminations but if left, can lead to catastrophic failure. More importantly, mechanical cracks, unless they are severe may not be detected by normal electrical testing of the completed circuit, failure only occurring at some later stage after moisture ingress.

The degree of mechanical stress generated on the printed circuit board is dependent upon several factors including the board material and thickness; the amount of solder and land pattern. The amount of solder applied is important, as an excessive amount reduces the chip's resistance to cracking.

It is Knowles' experience that more than 90% are due to board depanelisation, a process where two or more circuit boards are separated after soldering is complete. Other manufacturing stages that should be reviewed include:

- 1) Attaching rigid components such as connectors, relays, display panels, heat sinks etc.
- 2) Fitting conventional leaded components. Special care must be exercised when rigid terminals, as found on large can electrolytic capacitors, are inserted.
- 3) Storage of boards in such a manner which allows warping.
- 4) Automatic test equipment, particularly the type employing "bed of nails" and support pillars.
- 5) Positioning the circuit board in its enclosure especially where this is a "snap-fit".

Knowles were the first MLCC manufacturer to launch a flexible termination to significantly reduce the instances of mechanical cracking. FlexiCap™ termination introduces a certain amount of give into the termination layer absorbing damaging stress. Unlike similar systems, FlexiCap™ does not tear under tension, but absorbs the stress, so maintaining the characteristics of the MLCC.

SM Pad Design

Knowles conventional 2-terminal chip capacitors can generally be mounted using pad designs in accordance with IPC-7351, Generic Requirements for Surface Mount Design and Land Pattern Standards, but there are some other factors that have been shown to reduce mechanical stress, such as reducing the pad width to less than the chip width. In addition, the position of the chip on the board should also be considered.

3-Terminal components are not specifically covered by IPC-7351, but recommended pad dimensions are included in the Knowles catalogue / website for these components.

Soldering surface mount chip capacitors

Please see application note AN0028 "Soldering / Mounting Chip Capacitors, Radial Leaded Capacitors and EMI Filters" located at: <http://www.knowlescapacitors.com/Resources.aspx?tab=mlc§ion=mlcAN>

The volume of solder applied to the chip capacitor can influence the reliability of the device. Excessive solder can create thermal and tensile stresses on the component which can lead to fracturing of the chip or the solder joint itself. Insufficient or uneven solder application can result in weak bonds, rotation of the device off line or lifting of one terminal off the pad (tombstoning). The volume of solder is process and board pad size dependent.

Soldering methods commonly used in industry are Reflow Soldering, Wave Soldering and, to a lesser extent, Vapour Phase Soldering. All these methods involve thermal cycling of the components and therefore the rate of heating and cooling must be controlled to preclude thermal shocking of the devices.

Without mechanical restriction, thermally induced stresses are released once the capacitor attains a steady state condition. Capacitors bonded to substrates, however, will retain some stress, due primarily to the mismatch of expansion of the component to the substrate; the residual stress on the chip is also influenced by the ductility and hence the ability of the bonding medium to relieve the stress. Unfortunately, the thermal expansion of chip capacitors differ significantly from those of most substrate materials.

Large chips are more prone to thermal shock as their greater bulk will result in sharper thermal gradients within the device during thermal cycling. Large units experience excessive stress if processed through the fast cycles typical of solder wave or vapour phase operations.

Reflow soldering Surface Mount Chip Capacitors

Knowles recommend reflow soldering as the preferred method for mounting MLCCs. KPD MLCCs can be reflow soldered using a reflow profile generally as defined in IPC / JEDEC J-STD-020. Sn plated termination chip capacitors are compatible with both conventional and lead free soldering, with peak temperatures of 260°C to 270°C acceptable.

The heating ramp rate should be such that components see a temperature rise of 1.5°C to 4°C per seconds to maintain temperature uniformity through the MLCC. The time for which the solder is molten should be maintained at a minimum, so as to prevent solder leaching. Extended times above 230°C can cause problems with oxidation of Sn plating. Use of inert atmosphere can help if this problem is encountered. PdAg terminations can be particularly susceptible to leaching with lead free, tin rich solders and trials are recommended for this combination. Cooling to ambient temperature should be allowed to occur naturally, particularly if larger chip sizes are being soldered. Natural cooling allows a gradual relaxation of thermal mismatch stresses in the solder joints. Forced cooling should be avoided as this can induce thermal breakage.

Wave soldering Surface Mount Chip Capacitors

Wave soldering is generally acceptable, but the thermal stresses caused by the wave have been shown to lead to potential problems with larger or thicker chips. Particular care should be taken when soldering SM chips larger than size 1210 and with a thickness greater than 1.0mm for this reason. 0402 size components are not suitable for wave soldering. 0402 size components can also be susceptible to termination leaching and reflow soldering is recommended for this size MLCC.

Wave soldering exposes the devices to a large solder volume, hence the pad size area must be restricted to accept an amount of solder which is not detrimental to the chip size utilized. Typically the pad width is 66% of the component width, and the length is .030" (.760mm) longer than the termination band on the chip. An 0805 chip which is .050" wide and has a .020" termination band therefore requires a pad .033" wide by .050" in length. Opposing pads should be identical in size to preclude uneven solder fillets and mismatched surface tension forces which can misalign the device. It is preferred that the pad layout results in alignment of the long axis of the chips at right angles to the solder wave, to promote even wetting of all



Mounting, Soldering, Storage & Mechanical Precautions

terminals. Orientation of components in line with the board travel direction may require dual waves with solder turbulence to preclude cold solder joints on the trailing terminals of the devices, as these are blocked from full exposure to the solder by the body of the capacitor.

The pre-heat ramp should be such that the components see a temperature rise of 1.5°C to 4°C per second as for reflow soldering. This is to maintain temperature uniformity through the MLCC and prevent the formation of thermal gradients within the ceramic. The preheat temperature should be within 120°C maximum (100°C preferred) of the maximum solder temperature to minimise thermal shock. Maximum permissible wave temperature is 270°C for SM chips. Total immersion exposure time for Sn/Ni terminations is 30s at a wave temperature of 260°C. Note that for multiple soldering operations, including the rework, the soldering time is cumulative.

The total immersion time in the solder should be kept to a minimum. It is strongly recommended that plated terminations are specified for wave soldering applications. PdAg termination is particularly susceptible to leaching when subjected to lead free wave soldering and is not generally recommended for this application.

Cooling to ambient temperature should be allowed to occur naturally, particularly if larger chip sizes are being soldered. Natural cooling allows a gradual relaxation of thermal mismatch stresses in the solder joints. Forced cooling should be avoided as this can induce thermal breakage.

Vapour phase soldering Chip Capacitors

Vapour phase soldering can expose capacitors to similar thermal shock and stresses as wave soldering and the advice is generally the same. Particular care should be taken in soldering large capacitors to avoid thermal cracks being induced and natural cooling should be used to allow a gradual relaxation of stresses.

Hand soldering and rework of Chip Capacitors

Attachment using a soldering iron requires extra care and is accepted to have a risk of cracking of the chip. Precautions include preheating of the assembly to within 100°C of the solder flow temperature and the use of a fine tip iron which does not exceed 30 watts. In no circumstances should the tip of the iron be allowed to contact the chip directly.

KPD recommend hot air/gas as the preferred method for applying heat for rework. Apply even heat surrounding the component to minimise internal thermal gradients.

Minimise the rework heat duration and allow components to cool naturally after soldering.

Solder leaching

Leaching is the term for the dissolution of silver into the solder causing a failure of the termination system which causes increased ESR, $\tan \delta$ and open circuit faults, including ultimately the possibility of the chip becoming detached. Leaching occurs more readily with higher temperature solders and solders with a high tin content. Pb free solders can be very prone to leaching certain termination systems. To prevent leaching, exercise care when choosing solder alloys and minimize both maximum temperature and dwell time with the solder molten.

Plated terminations with nickel or copper anti leaching barrier layers are available in a range of top coat finishes to prevent leaching occurring. These finishes also include Syfer FlexiCap™ for improved stress resistance post soldering.

Bonding

Hybrid assembly using conductive epoxy or wire bonding requires the use of silver palladium or gold terminations. Nickel barrier termination is not practical in these applications, as intermetallics will form between the dissimilar metals. The ESR will increase over time and may eventually break contact when exposed to temperature cycling.

Cleaning

Chip capacitors can withstand common agents such as water, alcohol and degreaser solvents used for cleaning boards. Ascertain that no flux residues are left on the chip surfaces as these diminish electrical performance.

Handling

Ceramics are dense, hard, brittle and abrasive materials. They are liable to suffer mechanical damage, in the form of chips or cracks, if improperly handled.

Terminations may be abraded onto chip surfaces if loose chips are tumbled in bulk. Metallic tracks may be left on the chip surfaces which might pose a reliability hazard.

Components should never be handled with fingers; perspiration and skin oils can inhibit solderability and will aggravate cleaning.

Chip capacitors should never be handled with metallic instruments. Metal tweezers should never be used as these can chip the product and may leave abraded metal tracks on the product surface. Plastic or plastic coated metal types are readily available and recommended - these should be used with an absolute minimum of applied pressure.

Counting or visual inspection of chip capacitors is best performed on a clean glass or hard plastic surface.

If chips are dropped or subjected to rough handling, they should be visually inspected before use. Electrical inspection may also reveal gross damage via a change in capacitance, an increase in dissipation factor or a decrease either in insulation resistance or electrical strength.

Transportation

Where possible, any transportation should be carried out with the product in its unopened original packaging. If already opened, any environmental control agents supplied should be returned to packaging and the packaging re-sealed.

Avoid paper and card as a primary means of handling, packing, transportation and storage of loose components. Many grades have a sulphur content which will adversely affect termination solderability.

Loose chips should always be packed with sulphur-free wadding to prevent impact or abrasion damage during transportation.

Storage

Incorrect storage of components can lead to problems for the user. Rapid tarnishing of the terminations, with an associated degradation of solderability, will occur if the product comes into contact with industrial gases such as sulphur dioxide and chlorine. Storage in free air, particularly moist or polluted air, can result in termination oxidation.

Packaging should not be opened until the MLCs are required for use. If opened, the pack should be re-sealed as soon as is practicable. Alternatively, the contents could be kept in a sealed container with an environmental control agent.

Long term storage conditions, ideally, should be temperature controlled between -5 and +40°C and humidity controlled between 40 and 60% R.H.

Taped product should be stored out of direct sunlight, which might promote deterioration in tape or adhesive performance.

Product, stored under the conditions recommended above, in its "as received" packaging, has a minimum shelf life of 2 years.

Ceramic Chip Capacitors - Packaging information

Tape and reel packing of surface mounting chip capacitors for automatic placement are in accordance with IEC60286-3.

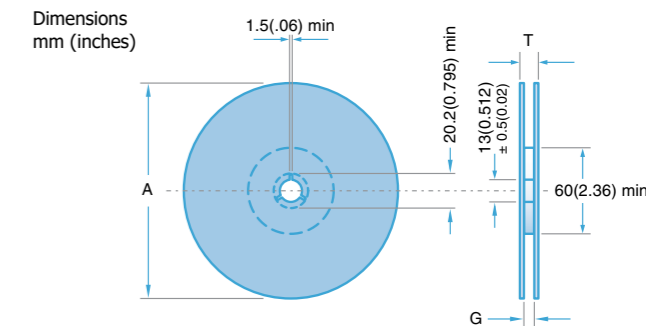
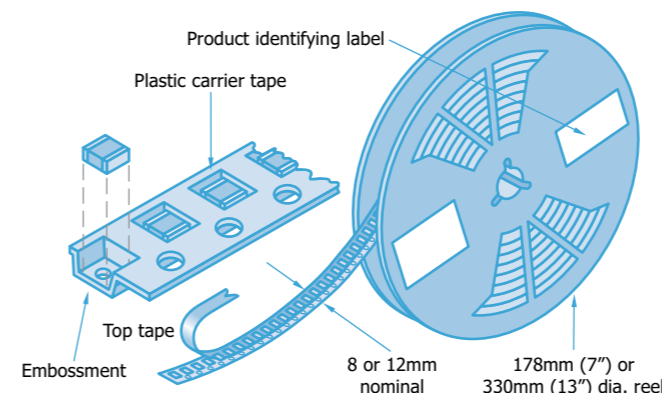

| Symbol | Description | 178mm reel | 330mm reel |
|--------|---------------|-----------------|-----------------|
| A | Diameter | 178 (7) | 330 (13) |
| G | Inside width | 8.4 (0.33) | 12.4 (0.49) |
| T | Outside width | 14.4 (0.56) max | 18.4 (0.72) max |

Peel force

The peel force of the top sealing tape is between 0.2 and 1.0 Newton at 180°. The breaking force of the carrier and sealing tape in the direction of unreeling is greater than 10 Newtons.

Identification

Each reel is labelled with the following information: manufacturer, chip size, capacitance, tolerance, rated voltage, dielectric type, batch number, date code and quantity of components.

Missing components

Maximum number of missing components shall be 1 per reel or 0.025% whichever is greater. There shall not be consecutive components missing from any reel for any reason.

Tape dimensions

Leader and Trailer

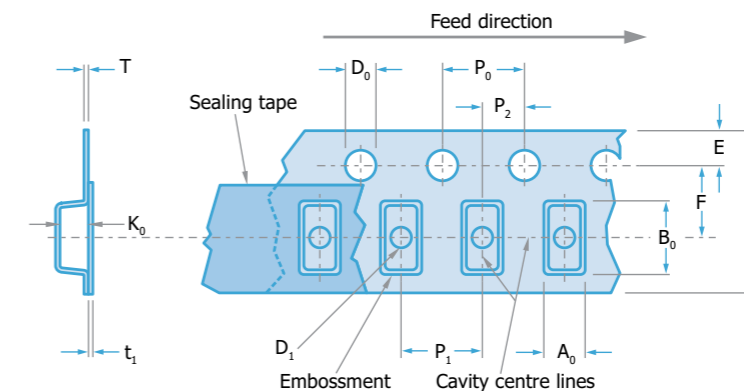
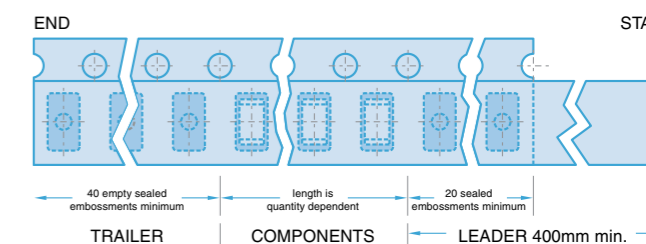

| Symbol | Description | Dimensions mm (inches) | |
|----------------|--|---|--------------------------|
| | | 8mm tape | 12mm tape |
| A ₀ | Width of cavity | Dependent on chip size to minimize rotation | |
| B ₀ | Length of cavity | | |
| K ₀ | Depth of cavity | | |
| W | Width of tape | 8.0 (0.315) | 12.0 (0.472) |
| F | Distance between drive hole centres and cavity centres | 3.5 (0.138) | 5.5 (0.213) |
| E | Distance between drive hole centres and tape edge | 1.75 (0.069) | |
| P ₁ | Distance between cavity centres | 4.0 (0.156) | 8.0 (0.315) |
| P ₂ | Axial distance between drive hole centres and cavity centres | 2.0 (0.079) | |
| P ₀ | Axial distance between drive hole centres | 4.0 (0.156) | |
| D ₀ | Drive hole diameter | 1.5 (0.059) | |
| D ₁ | Diameter of cavity piercing | 1.0 (0.039) | 1.5 (0.059) |
| T | Carrier tape thickness | 0.3 (0.012) ±0.1 (0.004) | 0.4 (0.016) ±0.1 (0.004) |
| t ₁ | Top tape thickness | 0.1 (0.004) max | |

Ceramic Chip Capacitors - Packaging information

Component orientation

Tape and reeling is in accordance with IEC 60286 part 3, which defines the packaging specifications of lead less components on continuous tapes.

- Notes: 1) IEC60286-3 states $A_0 \leq B_0$ (see tape dimensions on page 13).
 2) Regarding the orientation of 1825 and 2225 components, the termination bands are right to left, NOT front to back. Please see diagram.

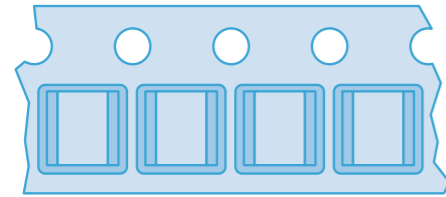

Orientation of 1825 & 2225 components

Outer Packaging

Outer carton dimensions mm (inches) max.

| Reel Size | No. of reels | L | W | T |
|------------|--------------|-------------|-------------|-----------|
| 178 (7.0) | 1 | 185 (7.28) | 185 (7.28) | 25 (0.98) |
| 178 (7.0) | 4 | 190 (7.48) | 195 (7.76) | 75 (2.95) |
| 330 (13.0) | 1 | 335 (13.19) | 335 (13.19) | 25 (0.98) |

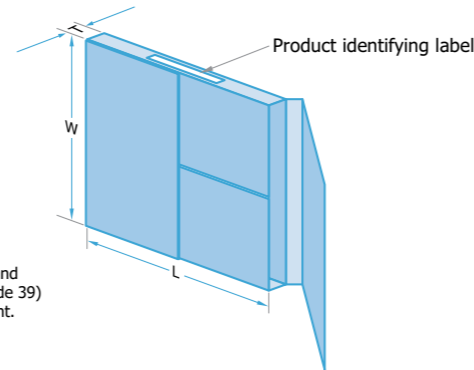

Note: Labelling of box and reel with bar codes (Code 39) available by arrangement.

Maximum reel quantities

| Chip size | 0402 | 0603 | 0805 | 1206 | 1210 | 1210 Suffix AG1 | 1808 | 1812 | 1825 | 2211 | 2215 | 2220 | 2225 | 3640 | 5550 | 8060 |
|------------------------|------|------|------|------|------|-----------------------|------|------|------|------|------|------|------|------|------|------|
| Reel quantities | | | | | | | | | | | | | | | | |
| 178mm (7") | 10k | 4000 | 3000 | 2500 | 2000 | 1500 | 1500 | 500 | 500 | 750 | 500 | 500 | 500 | - | - | - |
| 330mm (13") | 15k | 16k | 12k | 10k | 8000 | 6000 | 6000 | 2000 | 2000 | 4000 | 2000 | 2000 | 2000 | 500 | - | - |

Bulk packaging, tubs

Chips can be supplied in rigid re-sealable plastic tubs together with impact cushioning wadding. Tubs are labelled with the details: chip size, capacitance, tolerance, rated voltage, dielectric type, batch number, date code and quantity of components.

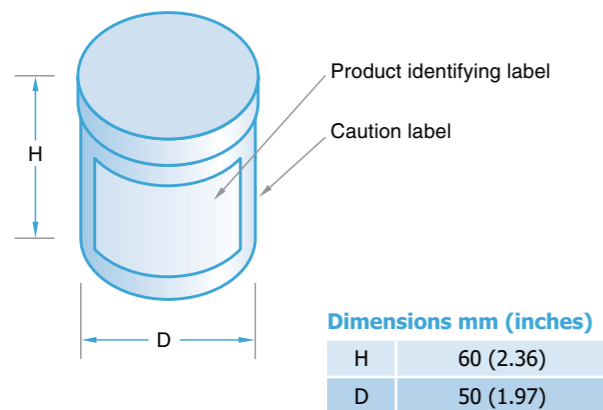

Dimensions mm (inches)

| | |
|---|-----------|
| H | 60 (2.36) |
| D | 50 (1.97) |

Chip dimensions

- For maximum chip thicknesses, refer to individual range tables in this catalogue.
- Non-standard thicknesses are available – consult your local KPD Sales Office.
- For special ranges, e.g. Surface Mount EMI Filters, dimensions may vary. See individual catalogue page.

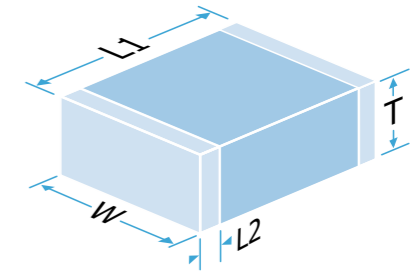

| Size | Length (L1) Parts with standard termination mm (inches) | Length (L1) Parts with polymer termination mm (inches) | Width (w) mm (inches) | Termination Band (L2) | |
|-------------|--|---|------------------------------|------------------------|------------------------|
| | | | | Minimum mm (inches) | Maximum mm (inches) |
| 0402 | 1.0 ± 0.10 (0.040 ± 0.004) | 1.0 +0.20/-0.10 (0.04 +0.008/-0.004) | 0.50 ± 0.10 (0.02 ± 0.004) | 0.10 (0.004) | 0.40 (0.016) |
| 0603 | 1.6 ± 0.15 (0.063 ± 0.006) | 1.6 +0.25/-0.15 (0.063 +0.01/-0.006) | 0.8 ± 0.15 (0.032 ± 0.006) | 0.20 (0.004) | 0.40 (0.016) |
| 0805 | 2.0 ± 0.20 (0.079 ± 0.008) | 2.0 +0.30/-0.20 (0.079 +0.012/-0.008) | 1.25 ± 0.20 (0.049 ± 0.008) | 0.25 (0.01) | 0.75 (0.030) |
| 1206 | 3.2 ± 0.20 (0.126 ± 0.008) | 3.2 +0.30/-0.20 (0.126 +0.012/-0.008) | 1.6 ± 0.20 (0.063 ± 0.008) | 0.25 (0.01) | 0.75 (0.030) |
| 1210 | 3.2 ± 0.20 (0.126 ± 0.008) | 3.2 +0.30/-0.20 (0.126 +0.012/-0.008) | 2.5 ± 0.20 (0.098 ± 0.008) | 0.25 (0.01) | 0.75 (0.030) |
| 1808 | 4.5 ± 0.35 (0.180 ± 0.014) | 4.5 +0.45/-0.35 (0.180 +0.018/-0.014) | 2.0 ± 0.30 (0.08 ± 0.012) | 0.25 (0.01) | 1.0 (0.04) |
| 1812 | 4.5 ± 0.30 (0.180 ± 0.012) | 4.5 +0.40/-0.30 (0.180 +0.016/-0.012) | 3.2 ± 0.20 (0.126 ± 0.008) | 0.25 (0.01) | 1.143 (0.045) |
| 1825 | 4.5 ± 0.30 (0.180 ± 0.012) | 4.5 +0.40/-0.30 (0.180 +0.016/-0.012) | 6.40 ± 0.40 (0.252 ± 0.016) | 0.25 (0.01) | 1.0 (0.04) |
| 2211 | 5.7 ± 0.40 (0.225 ± 0.016) | 5.7 +0.50/-0.40 (0.225 +0.02/-0.016) | 2.79 ± 0.30 (0.11 ± 0.012) | 0.25 (0.01) | 0.8 (0.03) |
| 2220 | 5.7 ± 0.40 (0.225 ± 0.016) | 5.7 +0.50/-0.40 (0.225 +0.02/-0.016) | 5.0 ± 0.40 (0.197 ± 0.016) | 0.25 (0.01) | 1.0 (0.04) |
| 2225 | 5.7 ± 0.40 (0.225 ± 0.016) | 5.7 +0.50/-0.40 (0.225 +0.02/-0.016) | 6.30 ± 0.40 (0.252 ± 0.016) | 0.25 (0.01) | 1.143 (0.045) |
| 3640 | 9.2 ± 0.50 (0.360 ± 0.02) | 9.2 +0.60/-0.50 (0.36 +0.024/-0.02) | 10.16 ± 0.50 (0.40 ± 0.02) | 0.50 (0.02) | 1.50 (0.06) |
| 5550 | 14.0 ± 0.711 (0.550 ± 0.028) | 14.0 +0.811/-0.711 (0.550 +0.032/-0.028) | 12.7 ± 0.635 (0.500 ± 0.025) | 0.50 (0.02) | 1.50 (0.06) |
| 8060 | 20.3 ± 0.5 (0.800 ± 0.02) | 20.3 +0.60/-0.50 (0.80 +0.024/-0.02) | 15.24 ± 0.50 (0.60 ± 0.02) | 0.50 (0.02) | 1.50 (0.06) |

X7R (2R1) - AEC-Q200 & Standard ranges - capacitance values

| | X7R (2R1) | 0402 | 0603 | 0805 | 1206 | 1210 | 1808 | 1812 | 1825 | 2220 | 2225 | 3640 | 5550 | 8060 | | | | | | | | | |
|--------------------|-----------------|--------------|---------------|--------------|---------------|---------------|---------------|---------------|---------------|---------------|---------------|---------------|-------------|---------------|---------------|---------------|-------|---------------|---------------|---------------|---------------|-------------|---------------|
| Part number suffix | - | - | - | - | - | NC | - | NC | - | NC | WS2 | - | - | NC | WS2 | - | - | WS2 | - | - | | | |
| Maximum Thickness | 0.61mm | 0.8mm | 0.9mm | 1.37mm | 1.7mm | 1.7mm | 2.0mm | 2.0mm | 2.0mm | 2.0mm | 2.5mm | 2.5mm | 3.2mm | 2.5mm | 2.5mm | 2.5mm | 4.5mm | 2.5mm | 2.5mm | 4.5mm | 2.5mm | 2.5mm | |
| 16V | AEC-Q200 | - | - | - | 220pF - 100nF | 220pF - 470nF | - | 10nF - 10µF | - | 1nF - 470nF | - | 1nF - 680nF | - | - | - | 1nF - 1.5µF | - | - | - | - | - | - | - |
| | Standard | - | 100pF - 100nF | - | 100pF - 330nF | 100pF - 1µF | - | 100pF - 1.5µF | - | 100pF - 1.5µF | - | 150pF - 3.3µF | - | - | 220pF - 4.7µF | 220pF - 5.6µF | - | - | 330pF - 6.8µF | - | - | - | - |
| 25V | AEC-Q200 | - | - | - | 220pF - 100nF | 220pF - 470nF | - | 10nF - 10µF | - | 1nF - 470nF | - | 1nF - 680nF | - | - | - | 1nF - 1.5µF | - | - | - | - | - | - | - |
| | Standard | 47pF - 10nF | 100pF - 100nF | - | 100pF - 220nF | 100pF - 820nF | - | 100pF - 1.2µF | - | 100pF - 1.2µF | - | 150pF - 2.2µF | - | - | 220pF - 3.9µF | 220pF - 4.7µF | - | - | 330pF - 5.6µF | - | - | - | - |
| 50/63V | AEC-Q200 | - | 100pF - 47nF | 56nF - 100nF | 100pF - 220nF | 100pF - 470nF | - | 100pF - 10µF | - | 100pF - 680nF | - | 150pF - 2.2µF | - | - | 220pF - 2.2µF | 220pF - 3.3µF | - | - | 330pF - 3.3µF | 470pF - 4.7µF | - | - | - |
| | Standard | 47pF - 5.6nF | 100pF - 47nF | 56nF - 100nF | 100pF - 220nF | 100pF - 470nF | - | 100pF - 1µF | - | 100pF - 680nF | - | 150pF - 2.2µF | - | - | 220pF - 2.2µF | 220pF - 3.3µF | - | - | 330pF - 3.3µF | 470pF - 10µF | - | 1nF - 15µF | 2.2nF - 22µF |
| 100V | AEC-Q200 | - | 100pF - 33nF | - | 100pF - 100nF | 100pF - 220nF | - | 100pF - 680nF | - | 100pF - 560nF | - | 150pF - 1µF | - | - | 220pF - 1.5µF | 220pF - 1.5µF | - | - | 330pF - 2.2µF | 470pF - 3.3µF | - | - | - |
| | Standard | 47pF - 3.3nF | 100pF - 33nF | - | 100pF - 100nF | 100pF - 330nF | - | 100pF - 680nF | - | 100pF - 560nF | - | 150pF - 1.5µF | - | - | 220pF - 1.5µF | 220pF - 2.2µF | - | - | 330pF - 2.7µF | 470pF - 5.6µF | - | 1nF - 10µF | 2.2nF - 15µF |
| 200/250V | AEC-Q200 | - | 100pF - 10nF | - | 100pF - 47nF | 100pF - 150nF | - | 100pF - 330nF | - | 100pF - 270nF | - | 150pF - 680nF | - | 820nF - 1µF | 220pF - 1µF | 220pF - 1.5µF | - | - | 330pF - 1.5µF | 470pF - 1.5µF | - | - | - |
| | Standard | 47pF - 1nF | 100pF - 10nF | - | 100pF - 56nF | 100pF - 150nF | - | 100pF - 330nF | - | 100pF - 270nF | - | 150pF - 680nF | - | 820nF - 1µF | 220pF - 1µF | 220pF - 1.5µF | - | 1.8µF - 2.2µF | 330pF - 1.5µF | 470pF - 3.3µF | 3.9µF - 5.6µF | 1nF - 5.6µF | 2.2nF - 10µF |
| 500V | AEC-Q200 | - | 1.5nF - 22nF | - | 100pF - 15nF | 100pF - 68nF | - | 100pF - 150nF | - | 100pF - 150nF | - | 150pF - 330nF | - | 390nF - 470nF | 220pF - 560nF | 220pF - 680nF | - | - | 330pF - 680nF | 470pF - 1µF | - | - | - |
| | Standard | - | 100pF - 2.2nF | - | 100pF - 15nF | 100pF - 68nF | - | 100pF - 150nF | - | 100pF - 150nF | - | 150pF - 330nF | - | 390nF - 470nF | 220pF - 560nF | 220pF - 680nF | - | 820nF - 1.2µF | 330pF - 820nF | 470pF - 1µF | 1.2µF - 2.7µF | 1nF - 1.8µF | 2.2nF - 3.3µF |
| 630V | AEC-Q200 | - | - | - | 220pF - 10nF | 100pF - 47nF | - | 100pF - 100nF | - | 100pF - 100nF | - | 150pF - 180nF | - | 220nF - 330nF | 220pF - 180nF | 220pF - 470nF | - | 390nF - 1µF | 330pF - 390nF | 470pF - 680nF | - | - | - |
| | Standard | - | - | - | 100pF - 10nF | 100pF - 47nF | - | 100pF - 100nF | - | 100pF - 100nF | - | 150pF - 180nF | - | 220nF - 330nF | 220pF - 180nF | 220pF - 470nF | - | 560nF - 1µF | 330pF - 390nF | 470pF - 680nF | 820nF - 2.2µF | 1nF - 1.2µF | 2.2nF - 2.2µF |
| 1kV | AEC-Q200 | - | - | - | 220pF - 4.7nF | 100pF - 12nF | - | 100pF - 47nF | - | 100pF - 47nF | - | 150pF - 100nF | - | 120nF - 180nF | 220pF - 180nF | 220pF - 150nF | - | 150nF - 470nF | 330pF - 150nF | 470nF - 180nF | 220nF - 1µF | - | - |
| | Standard | - | - | - | 100pF - 10nF | 100pF - 22nF | - | 100pF - 47nF | - | 100pF - 47nF | - | 150pF - 100nF | - | 120nF - 180nF | 220pF - 180nF | 220pF - 150nF | - | 180nF - 470nF | 330pF - 150nF | 470pF - 180nF | 220nF - 1µF | 1nF - 390nF | 2.2nF - 1µF |
| 1.2kV | AEC-Q200 | - | - | - | - | 100pF - 5.6nF | - | 100pF - 18nF | - | 100pF - 18nF | - | 150pF - 33nF | - | - | 220pF - 68nF | 220pF - 82nF | - | - | 330pF - 100nF | 470pF - 150nF | - | - | - |
| | Standard | - | - | - | - | 100pF - 15nF | - | 100pF - 18nF | - | 100pF - 22nF | - | 150pF - 33nF | - | 39nF - 100nF | 220pF - 68nF | 220pF - 82nF | - | 100nF - 220nF | 330pF - 100nF | 470pF - 150nF | 180nF - 470nF | 1nF - 220nF | 2.2nF - 470nF |
| 1.5kV | AEC-Q200 | - | - | - | - | 100pF - 5.6nF | - | 100pF - 10nF | - | 100pF - 10nF | - | 150pF - 22nF | - | - | 220pF - 47nF | 220pF - 68nF | - | - | 330pF - 68nF | 470pF - 100nF | - | - | - |
| | Standard | - | - | - | - | 100pF - 10nF | - | 100pF - 12nF | - | 100pF - 15nF | - | 150pF - 22nF | - | 27nF - 56nF | 220pF - 47nF | 220pF - 68nF | - | 82nF - 150nF | 330pF - 68nF | 470pF - 100nF | 120nF - 330nF | 1nF - 150nF | 2.2nF - 330nF |
| 2kV | AEC-Q200 | - | - | - | - | 100pF - 2.2nF | 2.7nF - 2.7nF | 100pF - 4.7nF | 5.6nF - 5.6nF | 100pF - 4.7nF | - | 150pF - 10nF | 12nF - 15nF | - | 220pF - 10nF | 220pF - 27nF | - | - | 330pF - 33nF | 470pF - 47nF | - | - | - |
| | Standard | - | - | - | - | 100pF - 2.2nF | 2.7nF - 3.3nF | 100pF - 4.7nF | 5.6nF - 5.6nF | 100pF - 4.7nF | 5.6nF - 5.6nF | 150pF - 10nF | 12nF - 15nF | - | 220pF - 10nF | 220pF - 33nF | - | 39nF - 100nF | 330pF - 33nF | 470pF - 47nF | 56nF - 150nF | 1nF - 82nF | 2.2nF - 150nF |
| 2.5kV | AEC-Q200 | - | - | - | - | 100pF - 1.5nF | - | 100pF - 4.7nF | 1nF - 1.5nF | 1.8nF - 2.7nF | 150pF - 3.3nF | 3.9nF - 10nF | - | 220pF - 4.7nF | 220pF - 8.2nF | 10nF - 18nF | - | - | 330pF - 12nF | 470pF - 22nF | - | - | - |
| | Standard | - | - | - | - | 220pF - 2.7nF | - | 680pF - 4.7nF | 100pF - 1.5nF | 1.8nF - 4.7nF | 150pF - 3.3nF | 3.9nF - 10nF | - | 220pF - 6.8nF | 220pF - 8.2nF | 10nF - 22nF | - | - | 330pF - 12nF | 470pF - 33nF | - | 1nF - 68nF | 2.2nF - 100nF |
| 3kV | AEC-Q200 | - | - | - | - | 100pF - 1nF | - | 100pF - 3.3nF | 1nF - 1.2nF | 1.5nF - 2.2nF | 150pF - 2.7nF | 3.3nF - 4.7nF | - | 220pF - 2.7nF | 220pF - 6.8nF | 8.2nF - 15nF | - | - | 330pF - 8.2nF | 470pF - 18nF | - | - | - |
| | Standard | - | - | - | - | 220pF - 1.5nF | - | 680pF - 3.3nF | 100pF - 1.2nF | 1.5nF - 3.3nF | 150pF - 2.7nF | 3.3nF - 4.7nF | - | 220pF - 3.9nF | 220pF - 6.8nF | 8.2nF - 15nF | - | - | 330pF - 8.2nF | 470pF - 22nF | - | 1nF - 47nF | 2.2n - 82nF |
| 4kV* | AEC-Q200 | - | - | - | - | - | - | - | 1nF - 1nF | 1.2nF - 1.5nF | 150pF - 2.2nF | - | - | - | 220pF - 4.7nF | 5.6nF - 6.8nF | - | - | - | - | - | - | - |
| | Standard | - | - | - | - | - | - | - | 100pF - 1nF | 1.2nF - 2.2nF | 150pF - 2.2nF | 2.7nF - 3.3nF | - | 220pF - 2.2nF | 220pF - 4.7nF | 5.6nF - 6.8nF | - | - | 330pF - 5.6nF | 470pF - 6.8nF | - | 1nF - 15nF | 2.2nF - 33nF |
| 5kV* | Standard | - | - | - | - | - | - | - | 100pF - 680pF | - | 150pF - 1.2nF | - | - | 220pF - 1.8nF | 220pF - 3.9nF | 4.7nF - 4.7nF | - | - | 330pF - 4.7nF | 470pF - 5.6nF | - | 1nF - 10nF | 2.2nF - 22nF |
| 6kV* | Standard | - | - | - | - | - | - | - | 100pF - 390pF | - | 150pF - 1nF | - | - | 220pF - 1.5nF | 220pF - 2.2nF | - | - | - | 330pF - 2.7nF | 470pF - 4.7nF | - | 1nF - 8.2nF | 1.8nF - 15nF |
| 8kV* | Standard | - | - | - | - | - | - | - | - | - | - | - | - | - | - | - | - | - | - | 470pF - 1.5nF | - | 1nF - 4.7nF | 1.8nF - 6.8nF |
| 10kV* | Standard | - | - | - | - | - | - | - | - | - | - | - | - | - | - | - | - | - | - | 470pF - 1nF | - | 1nF - 2.2nF | 1.8nF - 4.7nF |
| 12kV* | Standard | - | - | - | - | - | - | - | - | - | - | - | - | - | - | - | - | - | - | 470pF - 820pF | - | 1nF - 1.2nF | 1.8nF - 2.2nF |

Notes: 1) *Parts rated 4kV and above may require conformal coating post soldering.
 2) WS2 suffix relates to StackiCap™ high capacitance parts.
 3) NC suffix parts maximise capacitance at high voltages. These parts **must** be conformally coated after mounting, especially between the board and the component.
 4) Parts in this range may be dual-use under export control legislation and as such may be subject to export licence restrictions. Please refer to page 9 for more information on the dual-use regulations and contact the Sales office for further information on specific part numbers.

Ordering information - AEC-Q200 ranges

| 0805 | Y | 100 | 0103 | K | S | T | --- |
|--|--|--|---|---|--|--|---|
| Chip size | Termination | Voltage | Capacitance in picofarads (pF) | Capacitance tolerance | Dielectric Release codes | Packaging | Suffix code |
| 0603 0805 1206 1210 1808 1812 1825 2220 2225 3640 | <p>Y = FlexiCap™ termination base with Ni barrier (100% matte tin plating). RoHS compliant.</p> <p>H = FlexiCap™ termination base with Ni barrier (Tin/lead plating with min. 10% lead). Not RoHS compliant.</p> <p>J = Nickel barrier (100% matte tin plating). RoHS compliant. Lead free.</p> <p>A = Nickel barrier (Tin/lead plating with min. 10% lead). Not RoHS compliant.</p> | <p>016 = 16V 025 = 25V 050 = 50V 063 = 63V 100 = 100V 200 = 200V 250 = 250V 500 = 500V 630 = 630V 1K0 = 1kV 1K2 = 1.2kV 1K5 = 1.5kV 2K0 = 2kV 2K5 = 2.5kV 3K0 = 3kV</p> | <p>First digit is 0. Second and third digits are significant figures of capacitance code. The fourth digit is number of zeros following Example: 0103 = 10nF</p> | <p>F = ±1% G = ±2% J = ±5% K = ±10% M = ±20%</p> | <p>A = COG/NP0 (1B) to AEC-Q200 - original K = COG/NP0 (1B) to AEC-Q200 - recommended E = X7R (2R1) to AEC-Q200 - original S = X7R (2R1) to AEC-Q200 - recommended</p> | <p>T = 178mm (7") reel R = 330mm (13") reel B = Bulk pack - tubs or trays</p> | <p>AG1 = Special Thickness U99 = Special Thickness WS2 = StackiCap™ NC = Conformal coating required</p> |
| | Note: X7R (2R1) to AEC-Q200 is only available in Y or H termination. | | | Note: X7R (2R1) parts are available in J, K & M tolerances only. | | | |

Ordering information - Standard ranges

| 1210 | Y | 200 | 0103 | K | C | T | --- |
|--|--|---|---|---|--|--|---|
| Chip size | Termination | Voltage | Capacitance in picofarads (pF) | Capacitance tolerance | Dielectric Release codes | Packaging | Suffix code |
| 0402 0603 0805 1206 1210 1808 1812 1825 2220 2225 3640 5550 8060 | <p>Y = FlexiCap™ termination base with Ni barrier (100% matte tin plating). RoHS compliant.</p> <p>H = FlexiCap™ termination base with Ni barrier (Tin/lead plating with min. 10% lead). Not RoHS compliant.</p> <p>J = Nickel barrier (100% matte tin plating). RoHS compliant. Lead free.</p> <p>A = Nickel barrier (Tin/lead plating with min. 10% lead). Not RoHS compliant.</p> | <p>010 = 10V 016 = 16V 025 = 25V 050 = 50V 063 = 63V 100 = 100V 200 = 200V 250 = 250V 500 = 500V 630 = 630V 1K0 = 1kV 1K2 = 1.2kV 1K5 = 1.5kV 2K0 = 2kV 2K5 = 2.5kV 3K0 = 3kV 4K0 = 4kV 5K0 = 5kV 6K0 = 6kV 8K0 = 8kV 10K = 10kV 12K = 12kV</p> | <p>First digit is 0. Second and third digits are significant figures of capacitance code. The fourth digit is number of zeros following Example: 0103 = 10nF</p> | <p>F = ±1% G = ±2% J = ±5% K = ±10% M = ±20%</p> | <p>C = COG/NP0 (1B) X = X7R (2R1)</p> | <p>T = 178mm (7") reel R = 330mm (13") reel B = Bulk pack - tubs or trays</p> | <p>AG1 = Special Thickness U99 = Special Thickness WS2 = StackiCap™ NC = Conformal coating required</p> |
| | | | | Note: X7R (2R1) parts are available in J, K & M tolerances only. | Suffix coded parts only: C = COG/NP0 (1B) - original G = COG/NP0 (1B) - recommended X = X7R (2R1) - original J = X7R (2R1) - recommended | | |

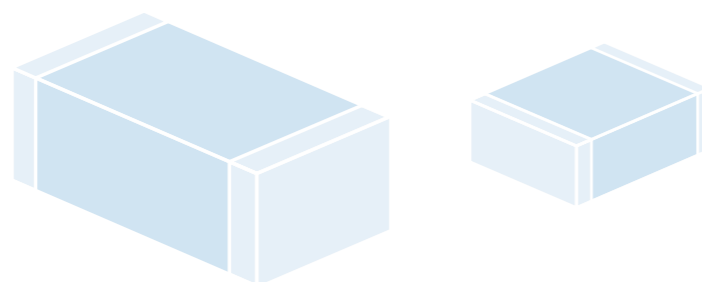

The StackiCap™ range offers a significant reduction in 'PCB real estate' for an equivalent capacitance value when board space is at a premium. For example, a standard 150nF chip in a 8060 case size is now available in a much smaller 3640 case size.

Knowles Precision Devices' unique patented* construction and FlexiCap™ termination material make the StackiCap™ range suitable for applications including: power supplies, lighting, aerospace electronics and high voltage applications where a large amount of capacitance is required.

Further developments are on-going, please contact the Sales Office for details of the full range.

* StackiCap™ technology is protected by international patents (pending) EP2847776, WO2013186172A1, US20150146343A1 and CN104471660A.



Maximum capacitance

Up to 5.6µF

Maximum voltage

Up to 2kV

Capacitance values - StackiCap™ Capacitors

| Chip size | 1812 | 2220 | 3640 |
|----------------|---------------|---------------|---------------|
| Max. Thickness | 3.5mm | 4.5mm | 4.2mm |
| 200/250V | 820nF - 1.0µF | 1.2µF - 2.2µF | 3.9µF - 5.6µF |
| 500V | 390nF - 470nF | 680nF - 1.2µF | 1.2µF - 2.7µF |
| 630V | 180nF - 330nF | 220nF - 330nF | 390nF - 1µF |
| 1kV | 120nF - 180nF | 150nF - 470nF | 220nF - 1µF |
| 1.2kV | 39nF - 100nF | 100nF - 220nF | 180nF - 470nF |
| 1.5kV | 27nF - 56nF | 56nF - 150nF | 120nF - 330nF |
| 2kV | - | 39nF - 100nF | 56nF - 150nF |

Note: = AEC-Q200

Ordering information - StackiCap™ Capacitors

| 1812 | Y | 500 | 0474 | K | J | T | WS2 |
|----------------------|--|--|--|---|--|--|-------------|
| Chip size | Termination | Voltage | Capacitance in picofarads (pF) | Capacitance tolerance | Dielectric | Packaging | Suffix code |
| 1812 2220 3640 | <p>Y = FlexiCap™ termination base with nickel barrier (100% matte tin plating). RoHS compliant. Lead free.</p> <p>H = FlexiCap™ Termination base with nickel barrier (Tin/lead plating with minimum 10% lead). Not RoHS compliant.</p> | <p>200 = 200V 250 = 250V 500 = 500V 630 = 630V 1K0 = 1kV 1K2 = 1.2kV 1K5 = 1.5kV 2K0 = 2kV</p> | <p>First digit is 0. Second and third digits are significant figures of capacitance code in picofarads (pF). Fourth digit is number of zeros eg. 0474 = 470nF Values are E12 series</p> | <p>J = ±5% K = ±10% M = ±20%</p> | <p>E = X7R (2R1) to AEC-Q200 X = X7R (2R1)</p> | <p>T = 178mm (7") reel R = 330mm (13") reel B = Bulk pack - tubs or trays</p> | WS2 |

Reeled quantities - StackiCap™ Capacitors

| | 1812 | 2220 | 3640 |
|------------------|-------|-------|------|
| 178mm (7") Reel | 500 | 500 | - |
| 330mm (13") Reel | 2,000 | 2,000 | 500 |



Notes: Parts in this range may be defined as dual-use under export control legislation and may be subject to export licence restrictions. Please refer to page 9 for more information on the dual-use regulations and contact the Sales Office for further information on specific part numbers.

250Vac Safety Certified AC Capacitors



a Knowles Precision Devices brand

Safety Certified capacitors comply with international UL and TÜV specifications to offer designers the option of using a surface mount ceramic multilayer capacitor to replace leaded film types. Offering the benefits of simple pick-and-place assembly, reduced board space required and lower profile, they are also available in a FlexiCap™ version to reduce the risk of mechanical cracking.

KPD's high voltage capacitor expertise means the range offers among the highest range available of capacitance values in certain case sizes.

Applications include: modems, AC-DC power supplies and where lightning strike or other voltage transients represent a threat to electronic equipment.

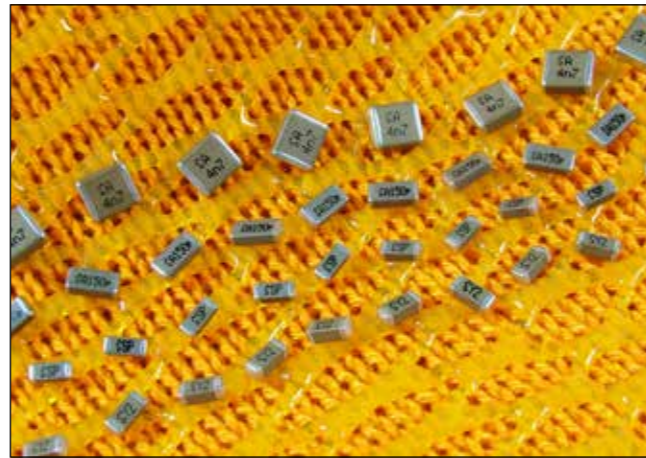

- Surface mount multilayer ceramic capacitors
- Meet Class Y2/X1, X1 and X2 requirements
- Approved for mains ac voltages, up to 250Vac
- Approved by UL and TÜV
- Sizes 1808, 1812, 2211, 2215 and 2220
- Smaller sizes suitable for use in equipment certified to EN60950

- Certification specifications for larger sizes include: IEC/EN60384-14, UL/CSA60950 and UL60384-14
- Surface mount package
- Reduces board area and height restrictions
- Reduced assembly costs over conventional through hole components
- FlexiCap™ option available on all sizes

250Vac Safety Certified Capacitors

| Dielectric | Approval Body | X1 PY2 | | X2 SP | Y2/X1 SP | | Y2/X1 B16 | X2 B17 |
|----------------|---------------|---------------|---------------|---------------|---------------|---------------|--------------|----------------------------------|
| | | 1808 | 1812 | | 2211 | 2215 | | |
| COG/NP0 (1B) | TÜV, UL | 4.7pF - 390pF | 4.7pF - 390pF | 4.7pF - 1.5nF | 4.7pF - 1nF | 820pF - 1nF | - | - |
| X7R (2R1) | TÜV, UL | 150pF - 1nF | 150pF - 2.2nF | 150pF - 4.7nF | 100pF - 3.9nF | 2.7nF - 3.9nF | 150pF - 10nF | 150pF - 22nF (TÜV approval only) |
| Max. thickness | | 2.0mm | 2.5mm | 2.0mm | 2.54mm | 2.54mm | 2.54mm* | 2.54mm** |

Note: ■ = AEC-Q200.
 * = Y2/X1 (B16) 2220 parts with values >5.6nF have a maximum thickness of 4.5mm.
 ** = X2 (B17) 2220 parts with values >10nF have a maximum thickness of 4.0mm.

| Class | Rated voltage | Impulse voltage | Insulation bridging | May be used in primary circuit |
|-------|---------------|-----------------|-------------------------|--------------------------------|
| Y1 | 250Vac | 8000V | Double or reinforced | Line to protective earth |
| Y2 | 250Vac | 5000V | Basic or supplementary* | Line to protective earth |
| Y4 | 150Vac | 2500V | Basic or supplementary* | Line to protective earth |
| X1 | 250Vac | 4000V | - | Line to line |
| X2 | 250Vac | 2500V | - | Line to line |
| X3 | 250Vac | None | - | Line to line |

* 2 x Y2 or Y4 rated may bridge double or reinforced insulation when used in series.

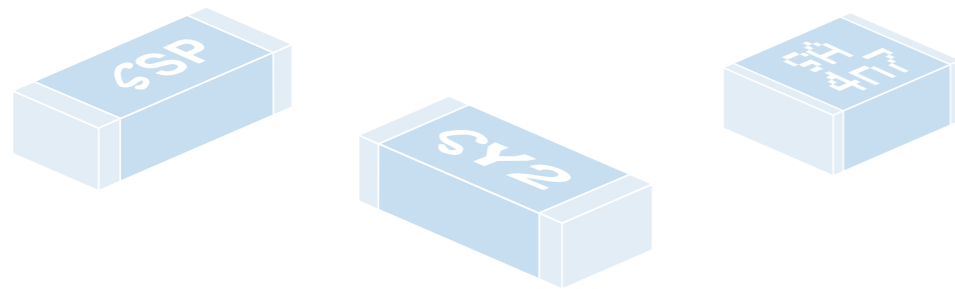

250Vac Safety Certified AC Capacitors



a Knowles Precision Devices brand

Classification and approval specification - Safety Certified capacitors

| CHIP SIZE | SUFFIX CODE | DIELECTRIC | CAP RANGE | CLASSIFICATION | APPROVAL SPECIFICATION | APPROVAL BODY | AEC-Q200 |
|-----------|--------------------|--------------|----------------|-----------------------|--|---------------|---|
| 1808 | SP ⁽¹⁾ | COG/NP0 (1B) | 4.7pF to 1.5nF | X2 NWGQ2, NWGQ8 | IEC60384-14 EN60384-14 UL-60950-1, 2nd Ed CSA 60950-1-07 2nd Ed | TÜV UL | TÜV & UL FULL RANGE |
| 1808 | SP ⁽¹⁾ | X7R (2R1) | 150pF to 4.7nF | X2 NWGQ2, NWGQ8 | IEC60384-14 EN60384-14 UL-60950-1, 2nd Ed CSA 60950-1-07 2nd Ed | TÜV UL | TÜV & UL FULL RANGE 'Y' TERM ONLY |
| 1808 | PY2 ⁽¹⁾ | COG/NP0 (1B) | 4.7pF to 390pF | X1 NWGQ2, NWGQ8 | IEC60384-14 EN60384-14 UL-60950-1, 2nd Ed CSA 60950-1-07 2nd Ed | TÜV UL | TÜV & UL FULL RANGE |
| 1808 | PY2 ⁽¹⁾ | X7R (2R1) | 150pF to 1nF | X1 NWGQ2, NWGQ8 | IEC60384-14 EN60384-14 UL-60950-1, 2nd Ed CSA 60950-1-07 2nd Ed | TÜV UL | TÜV & UL 1nF max. 'Y' TERM ONLY |
| 1812 | PY2 ⁽¹⁾ | COG/NP0 (1B) | 4.7pF to 390pF | X1 NWGQ2, NWGQ8 | IEC60384-14 EN60384-14 UL-60950-1, 2nd Ed CSA 60950-1-07 2nd Ed | TÜV UL | TÜV & UL FULL RANGE |
| 1812 | PY2 ⁽¹⁾ | X7R (2R1) | 150pF to 2.2nF | X1 NWGQ2, NWGQ8 | IEC60384-14 EN60384-14 UL-60950-1, 2nd Ed CSA 60950-1-07 2nd Ed | TÜV UL | TÜV & UL 2.2nF max. 'Y' TERM ONLY |
| 2211 | SP ⁽²⁾ | COG/NP0 (1B) | 4.7pF to 1nF | Y2/X1 NWGQ2, NWGQ8 | IEC60384-14 EN60384-14 UL-60950-1, 2nd Ed CSA 60950-1-07 2nd Ed | TÜV UL | TÜV & UL FULL RANGE |
| 2211 | SP ⁽²⁾ | X7R (2R1) | 100pF to 3.9nF | Y2/X1 NWGQ2, NWGQ8 | IEC60384-14 EN60384-14 UL-60950-1, 2nd Ed CSA 60950-1-07 2nd Ed | TÜV UL | TÜV & UL FULL RANGE 'Y' & 'H' TERM ONLY |
| 2215 | SP ⁽²⁾ | COG/NP0 (1B) | 820pF to 1nF | Y2/X1 NWGQ2, NWGQ8 | IEC60384-14 EN60384-14 UL-60950-1, 2nd Ed CSA 60950-1-07 2nd Ed | TÜV UL | TÜV & UL FULL RANGE |
| 2215 | SP ⁽²⁾ | X7R (2R1) | 2.7nF to 3.9nF | Y2/X1 NWGQ2, NWGQ8 | IEC60384-14 EN60384-14 UL-60950-1, 2nd Ed CSA 60950-1-07 2nd Ed | TÜV UL | TÜV & UL FULL RANGE 'Y' & 'H' TERM ONLY |
| 2220 | B16 ⁽³⁾ | X7R (2R1) | 150pF to 10nF | Y2/X1 FOWX2, FOWX8 | IEC60384-14 EN60384-14 UL-60384-14:2010 CSA E60384-14:09 | TÜV UL | TÜV & UL FULL RANGE 'Y' & 'H' TERM ONLY |
| 2220 | B17 ⁽²⁾ | X7R (2R1) | 150pF to 22nF | X2 | IEC60384-14 EN60384-14 | TÜV | TÜV ONLY 22nF max. 'Y' & 'H' TERM ONLY |

Notes: Termination availability

- (1) J & Y terminations only.
 - (2) J, Y, A & H terminations available.
 - (3) J, Y, A & H terminations available on values ≤5.6nF. Y & H terminations on values >5.6nF.
- PY2 Unmarked capacitors also available as released in accordance with approval specifications. Suffix Code SY2 applies.
 SP Unmarked capacitors also available as released in accordance with approval specifications. Suffix Code SPU applies.
 B16 Unmarked capacitors with a dual ac/dc rating are also available as released in accordance with approval specifications. Suffix Code U16 applies.
 B17 Unmarked capacitors with a dual ac/dc rating are also available as released in accordance with approval specifications. Suffix Code U17 applies.



250Vac Safety Certified AC Capacitors



Ordering information - Safety Certified capacitors - Class SPU/SP ranges

| 1808 | J | A25 | 0102 | J | C | T | SP |
|----------------------|--|--------------|--|---|---|--|---|
| Chip size | Termination | Voltage | Capacitance in picofarads (pF) | Capacitance tolerance | Dielectric codes | Packaging | Suffix code |
| 1808 2211 2215 | <p>*J = Nickel barrier (100% matte tin plating). RoHS compliant. Lead free.</p> <p>Y = FlexiCap™ termination base with nickel barrier (100% matte tin plating). RoHS compliant.</p> <p>2211/2215 only</p> <p>*A = Nickel barrier (Tin/lead plating with min. 10% lead). Not RoHS compliant.</p> <p>H = FlexiCap™ termination base with nickel barrier (Tin/lead plating with minimum 10% lead). Not RoHS compliant.</p> | A25 = 250Vac | <p>First digit is 0. Second and third digits are significant figures of capacitance code. The fourth digit is number of zeros following.</p> <p>Example: 0102 = 1nF</p> | <p><10pF B = ±0.10pF C = ±0.25pF D = ±0.50pF ≥ 10pF F = ±1% G = ±2% J = ±5% K = ±10% M = ±20%</p> <p>Note: X7R (2R1) parts are available in J, K & M tolerances only.</p> | <p>A = COG/NP0 (1B) to AEC-Q200 E = X7R (2R1) to AEC-Q200</p> <p>C = COG/NP0 (1B) X = X7R (2R1)</p> | <p>T = 178mm (7") reel R = 330mm (13") reel B = Bulk pack - tubs or trays</p> | <p>SP = Surge Protection capacitors (marked and approved)</p> <p>SPU = Surge Protection capacitors (un-marked parts are in accordance with but not certified)</p> |

Note: * J and A terminations are not available for dielectric code E.

Ordering information - Safety Certified capacitors - Class PY2/SY2

| 1808 | J | A25 | 0102 | J | X | T | PY2 |
|--------------|---|--------------|--|---|---|--|--|
| Chip size | Termination | Voltage | Capacitance in picofarads (pF) | Capacitance tolerance | Dielectric codes | Packaging | Suffix code |
| 1808 1812 | <p>*J = Nickel barrier (100% matte tin plating). RoHS compliant. Lead free.</p> <p>Y = FlexiCap™ termination base with nickel barrier (100% matte tin plating). RoHS compliant.</p> | A25 = 250Vac | <p>First digit is 0. Second and third digits are significant figures of capacitance code. The fourth digit is number of zeros following.</p> <p>Example: 0102 = 1nF</p> | <p><10pF B = ±0.10pF C = ±0.25pF D = ±0.50pF ≥ 10pF F = ±1% G = ±2% J = ±5% K = ±10% M = ±20%</p> <p>Note: X7R (2R1) parts are available in J, K & M tolerances only.</p> | <p>A = COG/NP0 (1B) to AEC-Q200 E = X7R (2R1) to AEC-Q200</p> <p>C = COG/NP0 (1B) X = X7R (2R1)</p> | <p>T = 178mm (7") reel R = 330mm (13") reel B = Bulk pack - tubs or trays</p> | <p>PY2 = Safety tested Surge Protection capacitors (marked and approved)</p> <p>SY2 = Surge Protection capacitors (un-marked parts are in accordance with but not certified)</p> |

Note: * J termination is not available for dielectric code E.

Ordering information - Safety Certified capacitors - Class B16/B17 ranges

| 2220 | J | A25 | 0102 | J | X | T | B16 |
|-----------|---|--------------|--|---|--|--|--|
| Chip size | Termination | Voltage | Capacitance in picofarads (pF) | Capacitance tolerance | Dielectric codes | Packaging | Suffix code |
| 2220 | <p>*J = Nickel barrier (100% matte tin plating). RoHS compliant. Lead free.</p> <p>Y = FlexiCap™ termination base with nickel barrier (100% matte tin plating). RoHS compliant.</p> <p>*A = Nickel barrier (Tin/lead plating with min. 10% lead). Not RoHS compliant.</p> <p>H = FlexiCap™ termination base with nickel barrier (Tin/lead plating with minimum 10% lead). Not RoHS compliant.</p> | A25 = 250Vac | <p>First digit is 0. Second and third digits are significant figures of capacitance code. The fourth digit is number of zeros following.</p> <p>Example: 0102 = 1nF</p> | <p>J = ±5% K = ±10% M = ±20%</p> | <p>E = X7R (2R1) to AEC-Q200 - original S = X7R (2R1) to AEC-Q200 - recommended</p> <p>X = X7R (2R1)</p> | <p>T = 178mm (7") reel 1000 pieces R = 330mm (13") reel 4000 pieces B = Bulk pack - tubs or trays</p> | <p>B16 = Type A: X¹/Y² B17 = Type B: X²</p> <p>U16 = Surge protection Unmarked Type A X1/Y2 capacitors (with a dual ac/dc rating are 'in accordance with' but not certified)</p> <p>U17 = Surge protection Unmarked Type B X2 capacitors (with a dual ac/dc rating are 'in accordance with' but not certified)</p> |

Note: * J and A terminations are not available for:
 Dielectric codes E and S (all capacitance values).
 Dielectric code X with suffix codes B16/U16 for capacitance values >5.6nF.

Open Mode Capacitors - COG/NP0 (1B) & X7R (2R1)



Open Mode capacitors have been designed specifically for use in applications where mechanical cracking is a severe problem and short circuits due to cracking are unacceptable.

Open Mode capacitors use inset electrode margins, which prevent any mechanical cracks which may form during board assembly from connecting to the internal electrodes.

When combined with FlexiCap™ termination, Open Mode capacitors provide a robust component with the assurance that if a part becomes cracked, the crack will be unlikely to result in short circuit failure.

Qualification included cracking the components by severe bend tests. Following the bend tests cracked components were subjected to endurance / humidity tests, with no failures evident due to short circuits. Note: Depending on the severity of the crack, capacitance loss was between 0% and 70%.



Note: = AEC-Q200.

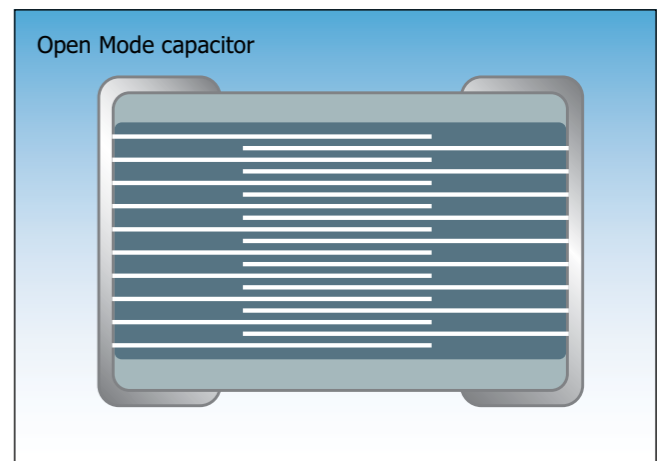

Open Mode - COG/NP0 (1B) - capacitance values

| COG/NP0 (1B) | 0603 | 0805 | 1206 | 1210 | 1808 | 1812 | 2220 | 2225 |
|----------------|-------|--------|-------|-------|-------|-------|-------|-------|
| Max. Thickness | 0.8mm | 1.37mm | 1.7mm | 2.0mm | 2.0mm | 2.5mm | 2.5mm | 2.5mm |
| Min cap | 10pF | 10pF | 10pF | 22pF | 22pF | 47pF | 68pF | 100pF |
| 16/25V | 82pF | 82pF | 82pF | 82pF | 82pF | 120pF | 180pF | 270pF |
| 50/63V | 82pF | 82pF | 82pF | 82pF | 82pF | 120pF | 180pF | 270pF |
| 100V | 82pF | 82pF | 82pF | 82pF | 82pF | 120pF | 180pF | 270pF |
| 200/250V | 82pF | 82pF | 82pF | 82pF | 82pF | 120pF | 180pF | 270pF |
| 500V | - | 82pF | 82pF | 82pF | 82pF | 120pF | 180pF | 270pF |
| 630V | - | 47pF | 82pF | 82pF | 82pF | 120pF | 180pF | 270pF |
| 1kV | - | 47pF | 82pF | 82pF | 82pF | 120pF | 180pF | 270pF |

Open Mode - X7R (2R1) - capacitance values

| X7R (2R1) | 0603 | 0805 | 1206 | 1210 | 1808 | 1812 | 2220 | 2225 |
|----------------|-------|--------|-------|-------|-------|-------|-------|-------|
| Max. Thickness | 0.8mm | 1.37mm | 1.7mm | 2.0mm | 2.0mm | 2.5mm | 2.5mm | 2.5mm |
| Min cap | 100pF | 100pF | 100pF | 100pF | 100pF | 150pF | 220pF | 330pF |
| 16V | 39nF | 100nF | 150nF | 220nF | 470nF | 470nF | 680nF | 1.5µF |
| 25V | 33nF | 100nF | 120nF | 220nF | 330nF | 470nF | 560nF | 1.2µF |
| 50/63V | 22nF | 100nF | 220nF | 470nF | 470nF | 1µF | 1.5µF | 2.7µF |
| 100V | 6.8nF | 27nF | 100nF | 220nF | 220nF | 680nF | 1µF | 1.5µF |
| 200/250V | 2.7nF | 22nF | 68nF | 100nF | 100nF | 330nF | 680nF | 1µF |
| 500V | - | 5.6nF | 39nF | 68nF | 68nF | 180nF | 330nF | 390nF |
| 630V | - | - | 22nF | 33nF | 27nF | 100nF | 180nF | 220nF |
| 1kV | - | - | 6.8nF | 15nF | 15nF | 47nF | 100nF | 100nF |

Ordering information - Open Mode Capacitors

| 1206 | Y | 050 | 0224 | K | X | T | --- |
|--|--|--|---|---|--|--|---|
| Chip size | Termination | Voltage | Capacitance in picofarads (pF) | Capacitance tolerance | Dielectric codes | Packaging | Suffix code |
| 0603 0805 1206 1210 1808 1812 2220 2225 | <p>Y = FlexiCap™ termination base with nickel barrier (100% matte tin plating). RoHS compliant.</p> | <p>016 = 16V 025 = 25V 050 = 50V 063 = 63V 100 = 100V 200 = 200V 250 = 250V 500 = 500V 630 = 630V 1K0 = 1kV</p> | <p>First digit is 0. Second and third digits are significant figures of capacitance code. The fourth digit is number of zeros following.</p> <p>Example: 0224 = 220000pF</p> | <p>F = ±1% G = ±2% J = ±5% K = ±10% M = ±20%</p> | <p>A = COG/NP0 (1B) to AEC-Q200 - original K = COG/NP0 (1B) to AEC-Q200 - recommended E = X7R (2R1) to AEC-Q200 - original S = X7R (2R1) to AEC-Q200 - recommended C = COG/NP0 (1B) X = X7R (2R1)</p> | <p>T = 178mm (7") reel R = 330mm (13") reel B = Bulk pack - tubs or trays</p> | <p>M01 = Open Mode capacitor</p> |

Note: X7R (2R1) parts are available in J, K & M tolerances only.

Tandem Capacitors - X7R (2R1)



Tandem Capacitors have been designed as a fail safe range using a series section internal design, for use in any application where short circuits would be unacceptable.

When combined with FlexiCap™ termination, Tandem capacitors provide an ultra robust and reliable component, for use in the most demanding applications.

Non-standard voltages are available. For more information please consult the Sales Office.

Qualification included cracking the components by severe bend tests. Following the bend tests cracked components were subjected to endurance / humidity tests, with no failures evident due to short circuits.
Note: Depending on the severity of the crack, capacitance loss was between 0% and 50%.

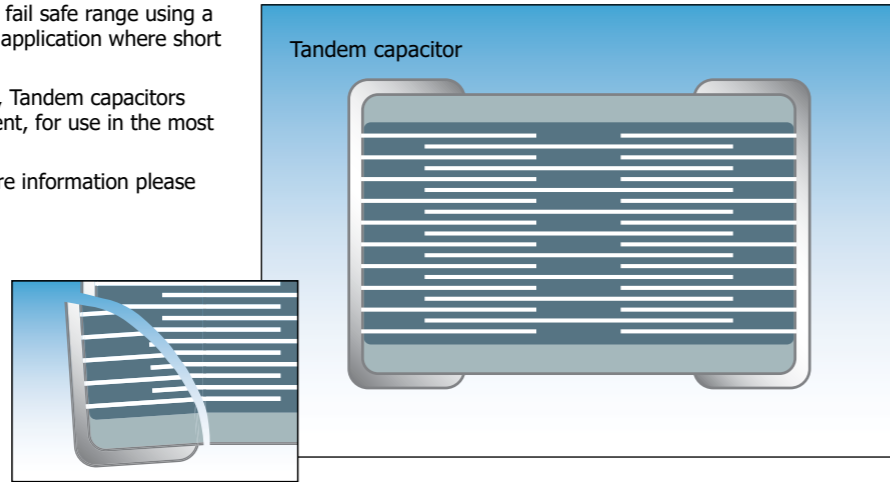

Tandem - X7R (2R1) - capacitance values

| X7R (2R1) | 0603 | 0805 | 1206 | 1210 | 1812 | 2220 | 2225 |
|----------------|-------|--------|-------|-------|-------|-------|-------|
| Max. Thickness | 0.8mm | 1.39mm | 1.7mm | 2.0mm | 2.0mm | 2.5mm | 2.5mm |
| Min cap | 100pF | 100pF | 100pF | 100pF | 150pF | 220pF | 330pF |
| 16V | 12nF | 47nF | 150nF | 270nF | 560nF | 1.2µF | 1.5µF |
| 25V | 10nF | 39nF | 120nF | 220nF | 470nF | 1µF | 1.2µF |
| 50/63V | 6.8nF | 33nF | 100nF | 180nF | 390nF | 680nF | 1µF |
| 100V | 2.2nF | 10nF | 47nF | 82nF | 220nF | 470nF | 680nF |
| 200/250V | 1nF | 4.7nF | 22nF | 47nF | 100nF | 220nF | 330nF |

Note: ■ = AEC-Q200.

Ordering information - Tandem Capacitors

| 1206 | Y | 050 | 0224 | K | X | T | --- |
|--|---|--|--|---------------------------------|--|--|------------------------|
| Chip size | Termination | Voltage | Capacitance in picofarads (pF) | Capacitance tolerance | Dielectric codes | Packaging | Suffix code |
| 0603 0805 1206 1210 1812 2220 2225 | Y = FlexiCap™ termination base with nickel barrier (100% matte tin plating). RoHS compliant. | 050 = 50V 063 = 63V 100 = 100V 200 = 200V 250 = 250V | First digit is 0. Second and third digits are significant figures of capacitance code. The fourth digit is number of zeros following. Example: 0224 = 220000pF | J = ±5% K = ±10% M = ±20% | E = X7R (2R1) to AEC-Q200 - original S = X7R (2R1) to AEC-Q200 - recommended X = X7R (2R1) | T = 178mm (7") reel R = 330mm (13") reel B = Bulk pack - tubs or trays | T01 = Tandem capacitor |

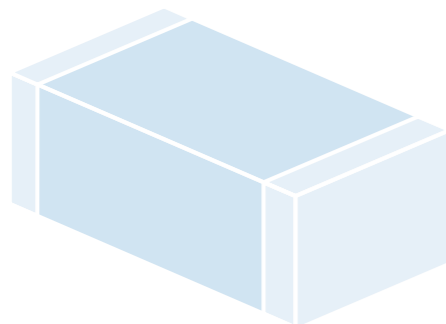

X8R High Temperature Caps - up to 150°C



The X8R dielectric will operate from -55°C to +150°C, with a maximum capacitance change ±15% (without applied voltage).

The devices are available in sizes 0805 to 2225, with voltage ranges from 25V to 3kV and capacitance values from 100pF to 2.2µF.

The capacitors have been developed by Knowles Precision Devices to meet demand from various applications in the automotive and industrial markets and in other electronic equipment exposed to high temperatures. The increased use of electronics in automotive "under the hood" applications has created demand for this product range.

The X8R range incorporates a specially formulated termination with a nickel barrier finish that has been designed to enhance the mechanical performance of these SMD chip capacitors in harsh environments typically present in automotive applications.



Capacitance Range

100pF to 2.2µF (0805 to 2225)

Temperature Coefficient of Capacitance (TCC)

±15% from -55°C to +150°C

Dissipation Factor (DF)

≤ 0.025

Termination

Nickel Barrier Tin Plated

Insulation Resistance (IR)

100G Ω or 1000secs (whichever is the less).

Dielectric Withstand Voltage (DWV)

2.5 x rated voltage for 5±1 seconds,
50mA charging current maximum.

Ageing Rate

1% per decade (typical)

X8R High Temperature Capacitors - capacitance values

| X8R | 0805 | 1206 | 1210 | 1808 | 1812 | 2220 | 2225 |
|----------------|--------|-------|-------|-------|-------|-------|-------|
| Max. Thickness | 1.37mm | 1.7mm | 2.0mm | 2.0mm | 2.5mm | 2.5mm | 2.5mm |
| Min cap | 100pF | 100pF | 100pF | 100pF | 150pF | 220pF | 330pF |
| Min cap | 220pF | 220pF | 220pF | 220pF | 220pF | 220pF | 330pF |
| 50V | 47nF | 150nF | 330nF | 330nF | 680nF | 1.2µF | 2.2µF |
| 100V | 33nF | 100nF | 220nF | 220nF | 470nF | 1µF | 1.5µF |
| 200/250V | 15nF | 68nF | 150nF | 150nF | 330nF | 680nF | 1µF |
| 500V | 4.7nF | 22nF | 47nF | 47nF | 120nF | 330nF | 470nF |
| 630V | 2.2nF | 10nF | 33nF | 33nF | 68nF | 180nF | 220nF |
| 1kV | 1.5nF | 3.3nF | 6.8nF | 6.8nF | 27nF | 68nF | 82nF |
| 1.2kV | - | 2.2nF | 5.6nF | 5.6nF | 15nF | 47nF | 56nF |
| 1.5kV | - | 1.5nF | 3.3nF | 3.3nF | 10nF | 27nF | 33nF |
| 2kV | - | 680pF | 1.5nF | 1.5nF | 5.6nF | 15nF | 22nF |
| 2.5kV | - | - | - | 1.2nF | 3.3nF | 10nF | 12nF |
| 3kV | - | - | - | 820pF | 2.7nF | 5.6nF | 6.8nF |

Note: ■ = AEC-Q200.

Ordering information - X8R High Temperature Capacitors

| 1206 | Y | 100 | 0473 | K | N | T |
|--|--|---|---|---------------------------------|-----------------------------|--|
| Chip size | Termination | Voltage d.c. | Capacitance in picofarads (pF) | Capacitance tolerance | Dielectric codes | Packaging |
| 0805 1206 1210 1808 1812 2220 2225 | Y = FlexiCap™ termination base with nickel barrier (100% matte tin plating). | 050 = 50V 100 = 100V 200 = 200V 250 = 250V 500 = 500V 630 = 630V 1K0 = 1kV 1K2 = 1.2kV 1K5 = 1.5kV 2K0 = 2kV 2K5 = 2.5kV 3K0 = 3kV | First digit is 0. Second and third digits are significant figures of capacitance code. The fourth digit is number of zeros following. Example: 0473 = 47000pF = 47nF | J = ±5% K = ±10% M = ±20% | N = X8R T = X8R AEC-Q200 | T = 178mm (7") reel R = 330mm (13") reel B = Bulk pack - tubs or trays |

Ultra-low ESR HiQ MLCCs - X8G range



a Knowles Precision Devices brand

The Ultra-low ESR HiQ X8G range offers a very stable, High Q material system that provides excellent low loss performance. Optimised for lowest possible ESR, the electrode system provides low metal losses resulting in flatter performance curves and reduced losses at higher frequencies. An extended operating temperature range of -55°C to +150°C accommodates modern high density micro electronics requirements. This range of high frequency capacitors is suitable for many applications where economical, high performance is required.



- Operating Temperature**
-55°C to +150°C (EIA X8G)
- Temperature Coefficient (Typical)**
0 ± 30 ppm/°C (EIA X8G)
- Insulation resistance**
Time constant (Ri xCr) (whichever is the least)
100GΩ or 1000s
- Q Factor**
>2000 @ 1MHz

Ultra-low ESR HiQ capacitors - X8G range - capacitance values

| Chip Size | 0402 | 0505 | 0603 | 0805 | 1111 |
|-----------------|-------------------|-------------------|-------------------|-------------------|------------------|
| Max. thickness | 0.6mm | 1.27mm | 0.8mm | 1.0mm | 2.2mm |
| Min cap | 0.2pF | 0.5pF | 0.2pF | 0.2pF | 0.5pF |
| Min cap | 0.3pF | 0.5pF | 0.3pF | 0.3pF | 0.5pF |
| 50V | 100pF | 1nF | 470pF | 1.5nF | 5.1nF |
| 100V | 100pF | - | 150pF | 820pF | 1.0nF |
| 250V | 30pF | 33pF | 150pF | 430pF | 820pF |
| 500V | 33pF | - | 150pF | 240pF | 430pF |
| 1kV | - | - | - | - | 1.3nF |
| Tape quantities | 7" reel - 10,000 | 7" reel - 2,500 | 7" reel - 4,000 | 7" reel - 3,000 | 7" reel - 1,000 |
| | 13" reel - 15,000 | 13" reel - 10,000 | 13" reel - 16,000 | 13" reel - 12,000 | 13" reel - 5,000 |

Notes: = AEC-Q200.
Below 1pF capacitance values are available in 0.1pF steps. Above 1pF capacitance values are available in E24 series values.

Ordering information - Ultra-low ESR HiQ capacitors - X8G range

| 0805 | J | 250 | 0101 | J | H | T |
|--------------------------------------|---|--|---|--|--|--|
| Chip size | Termination | Voltage | Capacitance in picofarads (pF) | Capacitance tolerance | Dielectric | Packaging |
| 0402 0505 0603 0805 1111 | J = Nickel barrier (100% matte tin plating). RoHS compliant. Lead free. | 050 = 50V 100 = 100V 250 = 250V 500 = 500V 1K0 = 1kV | <1.0pF: Insert a P for the decimal point as the first character. eg. P300 = 0.3pF Values in 0.1pF steps >1.0pF & <10pF: Insert a P for the decimal point as the second character. eg. 8P20 = 8.2pF Values are E24 series >10pF: First digit is 0. Second and third digits are significant figures of capacitance code. Fourth digit is number of zeros. eg. 0101 = 100pF Values are E24 series | <4.7pF H = ±0.05pF B = ±0.1pF C = ±0.25pF D = ±0.5pF <10pF B = ±0.1pF C = ±0.25pF D = ±0.5pF >10pF F = ±1% G = ±2% J = ±5% K = ±10% | V = Ultra-low ESR High Frequency X8G to AEC-Q200 H = Ultra-low ESR High Frequency X8G | T = 178mm (7") reel R = 330mm (13") reel B = Bulk pack - tubs or trays |

Ultra-low ESR HiQ MLCCs - X8G range



a Knowles Precision Devices brand

Typical performance - 0603 chip size

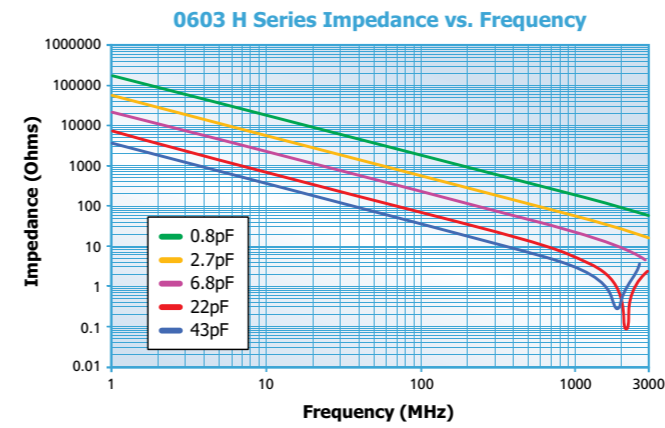

Typical performance - 0805 chip size

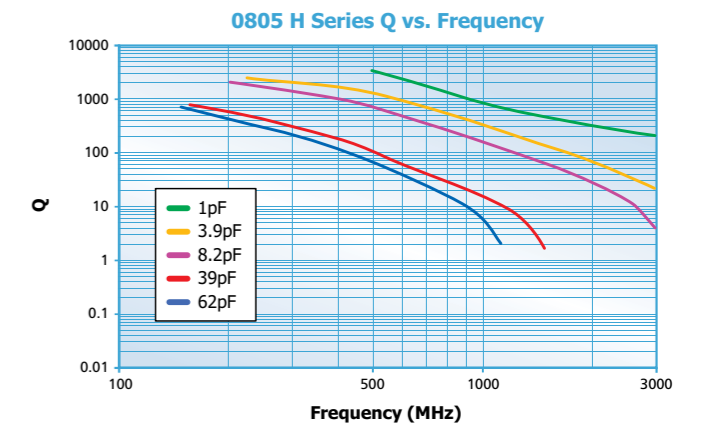
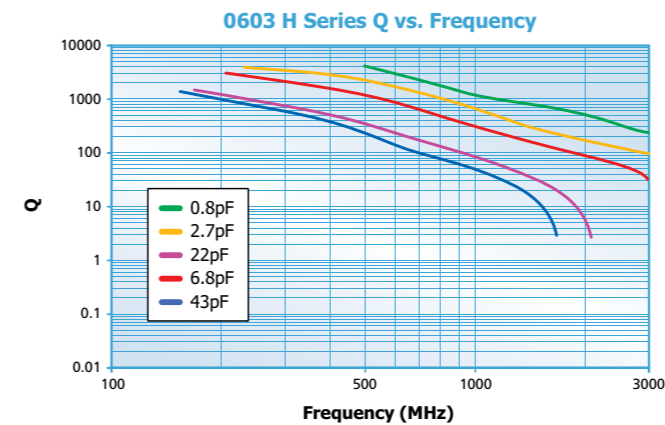
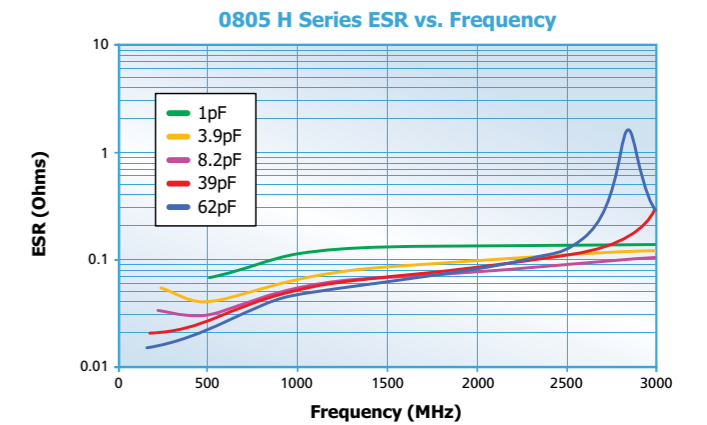
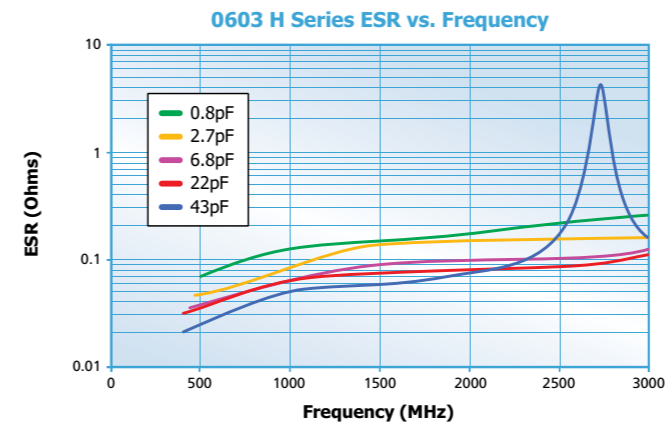
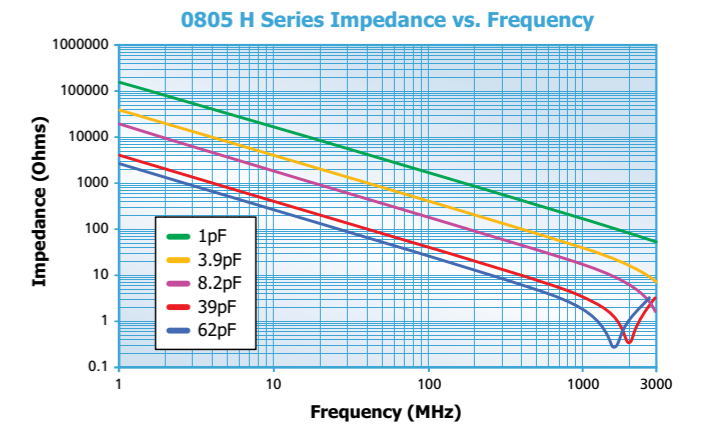

The E01 and E07 ranges of feedthrough MLCC chip 'C' filters are 3 terminal chip devices designed to offer reduced inductance compared to conventional MLCCs when used in signal line filtering.

The filtered signal passes through the chip internal electrodes and the noise is filtered to the grounded side contacts, resulting in reduced length noise transmission paths.

Available in COG/NP0 (1B) and X7R (2R1) dielectrics, with current ratings of 300mA, 1A, 2A, 3A and voltage ratings of 25Vdc to 200Vdc. Also available with FlexiCap™ termination which is strongly recommended for new designs.

Commonly used in automotive applications, a range qualified to AEC-Q200 is also available.



E01 300mA, E07 1A/2A/3A

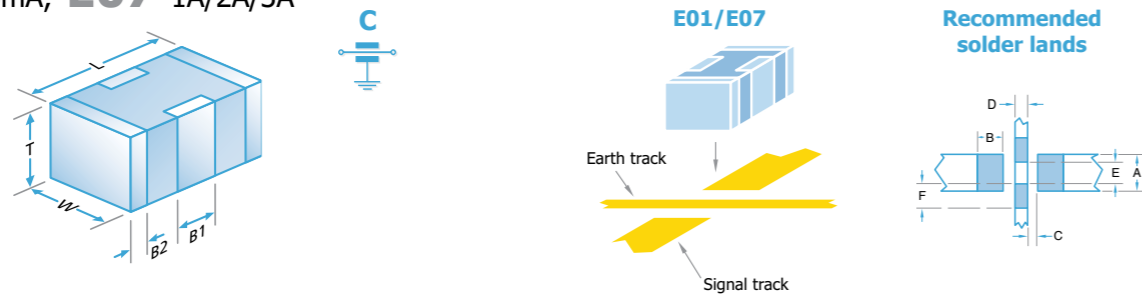

Dimensions

| | 0805 | 1206 | 1806 | 1812 | | 0805 | 1206 | 1806 | 1812 |
|-----------|-------------------------------|-------------------------------|-------------------------------|--------------------------------|----------|--------------|--------------|--------------|--------------|
| L | 2.0 ± 0.3 (0.079 ± 0.012) | 3.2 ± 0.3 (0.126 ± 0.012) | 4.5 ± 0.35 (0.177 ± 0.014) | 4.5 ± 0.35 (0.177 ± 0.014) | A | 0.95 (0.037) | 1.20 (0.047) | 1.2 (0.047) | 2.65 (0.104) |
| W | 1.25 ± 0.2 (0.049 ± 0.008) | 1.6 ± 0.2 (0.063 ± 0.008) | 1.6 ± 0.2 (0.063 ± 0.008) | 3.2 ± 0.3 (0.126 ± 0.012) | B | 0.90 (0.035) | 0.90 (0.035) | 1.40 (0.055) | 1.40 (0.055) |
| T | 1.0 ± 0.15 (0.039 ± 0.006) | 1.1 ± 0.2 (0.043 ± 0.008) | 1.1 ± 0.2 (0.043 ± 0.008) | 2.0 ± 0.3 (0.079 ± 0.012) | C | 0.30 (0.012) | 0.60 (0.024) | 0.80 (0.031) | 0.80 (0.031) |
| B1 | 0.60 ± 0.2 (0.024 ± 0.008) | 0.95 ± 0.3 (0.037 ± 0.012) | 1.4 ± 0.3 (0.055 ± 0.012) | 1.45 ± 0.35 (0.055 ± 0.012) | D | 0.40 (0.016) | 0.80 (0.031) | 1.40 (0.055) | 1.40 (0.055) |
| B2 | 0.3 ± 0.15 (0.012 ± 0.006) | 0.5 ± 0.25 (0.02 ± 0.01) | 0.5 ± 0.25 (0.02 ± 0.01) | 0.75 ± 0.25 (0.02 ± 0.01) | E | 0.75 (0.030) | 1.0 (0.039) | 1.0 (0.039) | 2.05 (0.080) |

- Notes: 1) All dimensions mm (inches).
 2) Pad widths less than chip width gives improved mechanical performance.
 3) The solder stencil should place 4 discrete solder pads. The unprinted distance between ground pads is shown as dim E.
 4) Insulating the earth track underneath the filters is acceptable and can help avoid displacement of filter during soldering but can result in residue entrapment under the chip.

Standard Range - E01 & E07 Feedthrough Capacitors

| Type | E01 | | | E07 | | | |
|--|--------------|---------------|---------------|---------------|---------------|--------------|---------------|
| Chip Size | 0805 | 1206 | 1806 | 0805 | 1206 | 1806 | 1812 |
| Max Current | 300mA | 300mA | 300mA | 1A | 2A | 2A | 3A |
| Rated Voltage | Dielectric | | | | | | |
| Minimum and maximum capacitance values | | | | | | | |
| 25Vdc | COG/NP0 (1B) | 180pF - 1.5nF | 560pF - 3.9nF | 820pF - 4.7nF | 180pF - 1.5nF | 560pF-3.9nF | 820pF-4.7nF |
| | X7R (2R1) | 470pF - 100nF | 5.6nF - 330nF | 3.9nF - 560nF | 820pF - 100nF | 10nF - 330nF | 22nF - 560nF |
| 50Vdc | COG/NP0 (1B) | 22pF - 820pF | 22pF - 3.3nF | 22pF - 3.9nF | 10pF - 220pF | 22pF - 1nF | 100pF - 1.5nF |
| | X7R (2R1) | 560pF - 68nF | 4.7nF - 220nF | 3.3nF - 330nF | 1nF - 68nF | 10nF - 220nF | 22nF - 330nF |
| 100Vdc | COG/NP0 (1B) | 22pF - 560pF | 22pF - 2.2nF | 22pF - 3.3nF | 10pF - 120pF | 22pF - 560pF | 100pF - 680pF |
| | X7R (2R1) | 560pF - 27nF | 1.8nF - 100nF | 3.3nF - 180nF | 1nF - 27nF | 10nF - 100nF | 22nF - 180nF |
| 200Vdc | COG/NP0 (1B) | - | 560pF - 1.2nF | 56pF - 1nF | - | 15pF - 180pF | 56pF - 470pF |
| | X7R (2R1) | - | 2.7nF - 56nF | 3.9nF - 100nF | - | 12nF - 56nF | 22nF - 100nF |

Note: E07 25Vdc COG/NP0 (1B) 1206 and 1806 ranges in green, have maximum current of 1A.

AEC-Q200 Qualified Range - E01 & E07 Feedthrough Capacitors - capacitance values

| Type | E01 | | | E07 | | |
|-----------|--------------|--------------|---------------|---------------|--------------|--------------|
| Chip Size | 0805 | 1206 | 1806 | 0805 | 1206 | 1806 |
| 50V | COG/NP0 (1B) | 22pF - 820pF | 22pF - 1nF | 22pF - 2.2nF | 10pF - 220pF | 22pF - 1nF |
| | X7R (2R1) | 560pF - 47nF | 4.7nF - 100nF | 3.3nF - 200nF | 1nF - 47nF | 10nF - 100nF |
| 100V | COG/NP0 (1B) | 22pF - 560pF | 22pF - 1nF | 22pF - 2.2nF | 10pF - 120pF | 22pF - 560pF |
| | X7R (2R1) | 560pF - 15nF | 1.8nF - 15nF | 3.3nF - 68nF | 1nF - 15nF | 10nF - 15nF |

Notes: ■ = AEC-Q200. For some lower capacitance parts, higher voltage rated parts may be supplied.

Open board insertion loss performance in 50Ω system

| Capacitance | Open Board Performance | | | | | Resonance Freq (MHz) approx. |
|-------------|------------------------|------|-------|--------|------|------------------------------|
| | 0.1MHz | 1MHz | 10MHz | 100MHz | 1GHz | |
| 10pF | 0 | 0 | 0 | 0 | 7.5 | 2200 |
| 22pF | 0 | 0 | 0 | 0 | 16 | 1600 |
| 33pF | 0 | 0 | 0 | 1 | 22 | 1350 |
| 47pF | 0 | 0 | 0 | 2 | 28 | 1150 |
| 68pF | 0 | 0 | 0 | 3 | 41 | 900 |
| 100pF | 0 | 0 | 0 | 5 | 28 | 800 |
| 150pF | 0 | 0 | 0 | 8 | 24 | 700 |
| 220pF | 0 | 0 | 0 | 12 | 20 | 600 |
| 330pF | 0 | 0 | 1 | 15 | 20 | 500 |
| 470pF | 0 | 0 | 2 | 18 | 20 | 425 |
| 560pF | 0 | 0 | 3 | 20 | 20 | 350 |
| 680pF | 0 | 0 | 4 | 22 | 20 | 300 |
| 820pF | 0 | 0 | 5 | 24 | 20 | 260 |
| 1nF | 0 | 0 | 7 | 27 | 20 | 220 |
| 1.5nF | 0 | 0 | 9 | 31 | 20 | 200 |
| 2.2nF | 0 | 0 | 12 | 34 | 20 | 170 |
| 3.3nF | 0 | 1 | 14 | 39 | 20 | 135 |
| 4.7nF | 0 | 2 | 18 | 46 | 20 | 110 |
| 6.8nF | 0 | 3 | 21 | 50 | 20 | 90 |
| 10nF | 0 | 5 | 24 | 48 | 20 | 80 |
| 15nF | 0 | 8 | 27 | 45 | 20 | 65 |
| 22nF | 0 | 12 | 31 | 43 | 20 | 56 |
| 33nF | 1 | 14 | 34 | 40 | 20 | 40 |
| 47nF | 2 | 17 | 38 | 40 | 20 | 34 |
| 68nF | 4 | 20 | 41 | 40 | 20 | 30 |
| 100nF | 6 | 24 | 45 | 40 | 20 | 28 |
| 150nF | 8 | 26 | 48 | 40 | 20 | 24 |
| 220nF | 10 | 30 | 52 | 40 | 20 | 17 |
| 330nF | 13 | 33 | 55 | 40 | 20 | 15.5 |
| 470nF | 16 | 36 | 60 | 40 | 20 | 14 |
| 560nF | 18 | 39 | 65 | 40 | 20 | 12 |

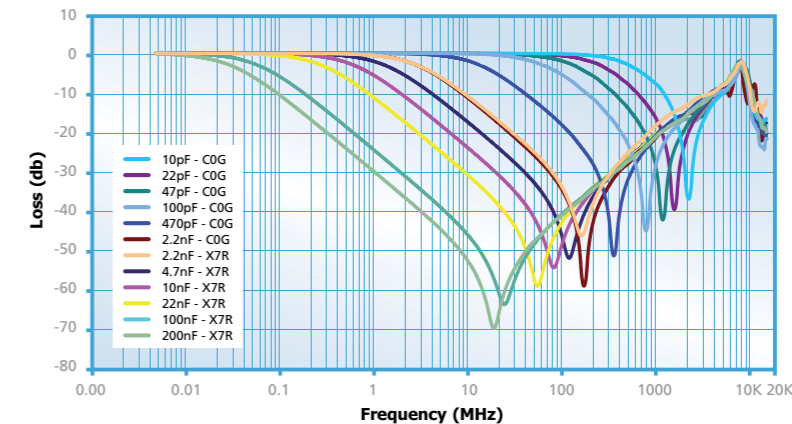

Ordering Information - E01 & E07 feedthrough capacitors

| 1206 | Y | 100 | 0103 | M | X | T | E07 |
|------------------------------|---|--|--|-----------|--|---|------------|
| Chip size | Termination | Voltage | Capacitance in picofarads (pF) | Tolerance | Dielectric | Packaging | Type |
| 0805 1206 1806 1812 | J = Nickel Barrier (Tin) *Y = FlexiCap™ (Tin - X7R (2R1) only) *A = (Tin/Lead) Not RoHS compliant. *H = FlexiCap™ (Tin/Lead) Not RoHS compliant. | 025 = 25V 050 = 50V 100 = 100V 200 = 200V | First digit is 0. Second and third digits are significant figures of capacitance code. The fourth digit is number of zeros following Example: 0103 = 10000pF. | M = ±20% | A = COG/NP0 (1B) to AEC-Q200 E = X7R (2R1) to AEC-Q200 C = COG/NP0 (1B) X = X7R (2R1) | T = 178mm (7") reel R = 330mm (13") reel B = Bulk | E01 E07 |

Notes: A, Y and H terminations are not available for dielectric codes A and C.
 J and A terminations are not available for dielectric code E.
 Please contact our Sales Office for any special requirements.

| Reeled quantities | 178mm (7") reel | 0805 | 1206 | 1806 | 1812 | 330mm (13") reel | 0805 | 1206 | 1806 | 1812 |
|-------------------|-----------------|------|------|------|------|------------------|-------|-------|-------|------|
| | | 3000 | 2500 | 2500 | 500 | | 12000 | 10000 | 10000 | 2000 |



The X2Y Integrated Passive Component is a 3 terminal EMI chip device.

When used in balanced line applications, the revolutionary design provides simultaneous line-to-line and line-to-ground filtering, using a single ceramic chip. In this way, differential and common mode filtering are provided in one device.

For unbalanced applications, it provides ultra low ESL (equivalent series inductance). Capable of replacing 2 or more conventional devices, it is ideal for balanced and unbalanced lines, twisted pairs and dc motors, in automotive, audio, sensor and other applications.

Available in sizes from 0805 to 1812, these filters can prove invaluable in meeting stringent EMC demands.

Manufactured by Knowles Capacitors under licence from X2Y Attenuators LLC.



Dielectric
X7R (2R1) or COG/NPO (1B)

Electrical configuration
Multiple capacitance

Capacitance measurement
At 1000hr point

Typical capacitance matching
Better than 5%
(down to 1% available on request)

Temperature rating
-55°C to 125°C

Insulation resistance
100Gohms or 1000s (whichever is the less)

Dielectric withstand voltage
≤200V 2.5 times rated Volts for 5 secs
500V 1.5 times rated Volts for 5 secs
Charging current limited to 50mA Max.

| Type | | E03 | | | |
|---------------|--------------|---------------|---------------|---------------|---------------|
| Chip size | | 0805 | 1206 | 1410 | 1812 |
| Rated voltage | Dielectric | | | | |
| 25Vdc | COG/NPO (1B) | 560pF - 820pF | 1.8nF - 3.3nF | 6.8nF - 8.2nF | 12nF - 15nF |
| | X7R (2R1) | 56nF - 68nF | - | 470nF - 470nF | 820nF - 820nF |
| 50Vdc | COG/NPO (1B) | 390pF - 470pF | 1.2nF - 1.5nF | 4.7nF - 5.6nF | 8.2nF - 10nF |
| | X7R (2R1) | 18nF - 47nF | 56nF - 220nF | 180nF - 400nF | 390nF - 680nF |
| 100Vdc | COG/NPO (1B) | 10pF - 330pF | 22pF - 1nF | 100pF - 3.9nF | 820pF - 6.8nF |
| | X7R (2R1) | 470pF - 15nF | 1.5nF - 47nF | 4.7nF - 150nF | 8.2nF - 330nF |
| 200Vdc | COG/NPO (1B) | - | 22pF - 1nF | 100pF - 3.3nF | 820pF - 5.6nF |
| | X7R (2R1) | - | 820pF - 33nF | 1.2nF - 120nF | 2.7nF - 180nF |
| 500Vdc | COG/NPO (1B) | - | - | - | 820pF - 3.9nF |
| | X7R (2R1) | - | - | - | 2.7nF - 100nF |

Note: For some lower capacitance parts, higher voltage rated parts may be supplied.

AEC-Q200 range (E03) - capacitance values

| Chip size | | 0805 | 1206 | 1410 | 1812 |
|-----------|--------------|---------------|---------------|---------------|---------------|
| 50Vdc | COG/NPO (1B) | 390pF - 470pF | 1.2nF - 1.5nF | 4.7nF - 5.6nF | 8.2nF - 10nF |
| | X7R (2R1) | 18nF - 33nF | 56nF - 150nF | 180nF - 330nF | 390nF - 560nF |
| 100Vdc | COG/NPO (1B) | 10pF - 330pF | 22pF - 1nF | 100pF - 3.9nF | 820pF - 6.8nF |
| | X7R (2R1) | 470pF - 15nF | 1.5nF - 47nF | 4.7nF - 150nF | 8.2nF - 330nF |

Note: = AEC-Q200.

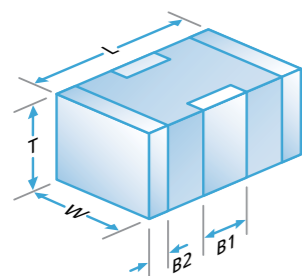

| | 0805 | 1206 | 1410 | 1812 |
|----|------------------------|------------------------|-------------------------|-------------------------|
| L | 2.0±0.3 (0.08±0.012) | 3.2±0.3 (0.126±0.012) | 3.6±0.3 (0.14±0.012) | 4.5±0.35 (0.18±0.014) |
| W | 1.25±0.2 (0.05±0.008) | 1.60±0.2 (0.063±0.008) | 2.5±0.3 (0.1±0.012) | 3.2±0.3 (0.126±0.012) |
| T | 1.0±0.15 (0.04±0.006) | 1.1±0.2 (0.043±0.008) | 2.0 max. (0.08 max.) | 2.1 max. (0.08 max.) |
| B1 | 0.5±0.25 (0.02±0.01) | 0.95±0.3 (0.037±0.012) | 1.20±0.3 (0.047±0.012) | 1.4±0.35 (0.06±0.014) |
| B2 | 0.3±0.15 (0.012±0.006) | 0.5±0.25 (0.02±0.01) | 0.5±0.25 (0.02±0.01) | 0.75±0.25 (0.03±0.01) |

- Notes:
- All dimensions mm (inches).
 - Pad widths less than chip width gives improved mechanical performance.
 - The solder stencil should place 4 discrete solder pads. The un-printed distance between ground pads is shown as dim E.
 - Insulating the earth track underneath the filters is acceptable and can help avoid displacement of filter during soldering but can result in residue entrapment under the chip.

Recommended solder lands

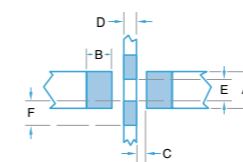

| | 0805 | 1206 | 1410 | 1812 |
|---|--------------|-------------|--------------|--------------|
| A | 0.95 (0.037) | 1.2 (0.047) | 2.05 (0.08) | 2.65 (0.104) |
| B | 0.9 (0.035) | 0.9 (0.035) | 1.0 (0.040) | 1.4 (0.055) |
| C | 0.3 (0.012) | 0.6 (0.024) | 0.7 (0.028) | 0.8 (0.031) |
| D | 0.4 (0.016) | 0.8 (0.031) | 0.9 (0.035) | 1.4 (0.055) |
| E | 0.75 (0.030) | 1.0 (0.039) | 1.85 (0.071) | 2.05 (0.080) |

| Component | Advantages | Disadvantages | Applications |
|---|--|---|---|
| Chip capacitor | Industry standard | Requires 1 per line High inductance Capacitance matching problems | By-pass Low frequency |
| 3 terminal feedthrough | Feedthrough Lower inductance | Current limited | Feedthrough Unbalanced lines High frequency |
| Syfer X2Y Integrated Passive Component | Very low inductance Replaces 2 (or 3) components Negates the effects of temperature, voltage and ageing Provides both common mode and differential mode attenuation Can be used on balanced & unbalanced lines | Care must be taken to optimise circuit design | By-pass Balanced lines High frequency dc electric motors Unbalanced lines Audio amplifiers CANBUS |

Filtering application

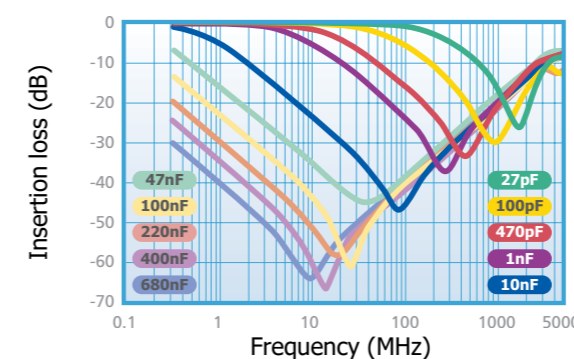
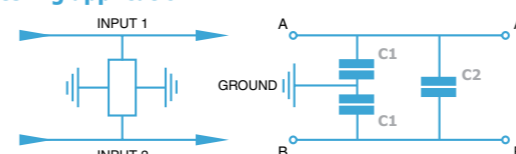

Decoupling application

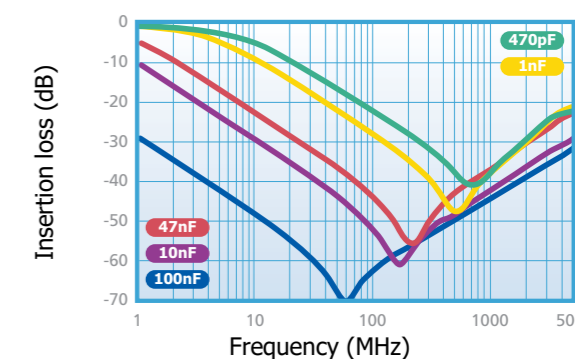
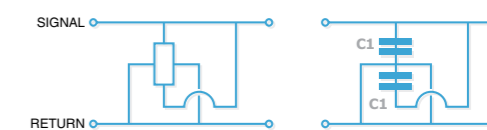

Ordering Information - X2Y IPC range

| 1812 | Y | 100 | 0334 | M | X | T | E03 |
|------------------------------|---|--|--|---|--|---|----------------------------------|
| Chip Size | Termination | Voltage | Capacitance in picofarads (pF) C1 | Tolerance | Dielectric | Packaging | Type |
| 0805 1206 1410 1812 | J = Nickel Barrier (Tin) *Y = FlexiCap™ (Tin - X7R (2R1) only) *A = (Tin/Lead) Not RoHS compliant. *H = FlexiCap™ (Tin/Lead) Not RoHS compliant. | 025 = 25V 050 = 50V 100 = 100V 200 = 200V 500 = 500V | First digit is 0. Second and third digits are significant figures of capacitance code. The fourth digit is number of zeros following Example: 0334=330nF. Note: C ₁ = 2C ₂ | M = ±20% (Tighter tolerances may be available on request). | A = COG/NPO (1B) to AEC-Q200 E = X7R (2R1) to AEC-Q200 C = COG/NPO (1B) X = X7R (2R1) | T = 178mm (7") reel R = 330mm (13") reel B = Bulk | X2Y Integrated Passive Component |

Notes: A, Y and H terminations are not available for dielectric codes A and C.
J and A terminations are not available for dielectric code E.
Please contact our Sales Office for any special requirements.

Reeled quantities

| 178mm (7") reel | 0805 | 1206 | 1410 | 1812 | 330mm (13") reel | 0805 | 1206 | 1410 | 1812 |
|-----------------|------|------|------|------|------------------|-------|-------|------|------|
| | 3000 | 2500 | 2000 | 500 | | 12000 | 10000 | 8000 | 2000 |



Other products available from that may interest you that are not AEC-Q200 qualified.

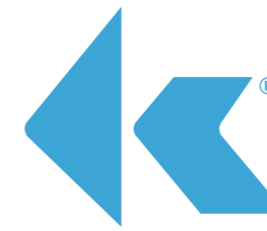

knowles
PRECISION DEVICES

VC1 Residual Capacitors - X7R (2R1)

The VC1 residual capacitance range MLCCs provide a more stable capacitance value with voltage - not to drop below 50% of the 1Vrms 1kHz value, up to full rated DC voltage, at room temperature.

They can be operated continuously at full rated voltage, but if derated will maintain a larger percentage of their original capacitance value, e.g. at 80% RV capacitance value equals 60% approx - see graph.

Defined capacitance value in case sizes from 0805 to 3640, with voltage rating up to 3kV. Ideal for Power supplies, capacitance critical circuits, smoothing circuits and EMI suppression.

Operating Temperature

-55°C to +125°C

Temperature Coefficient (Typical)

± 15%

Insulation Resistance at +25°C

Time constant (Ri xCr) (whichever is the least) 100GΩ or 1000s

Ageing Rate

Typical 1% per time decade

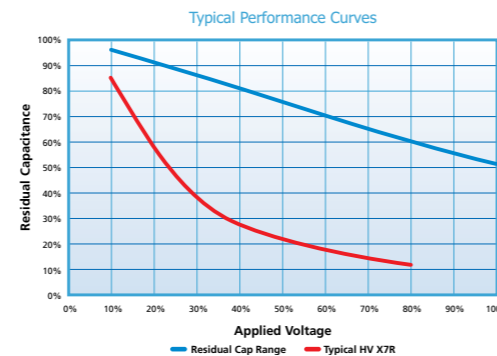

Minimum/maximum capacitance values - VC1 Capacitors

| Chip Size | 0805 | 1206 | 1210 | 1808 | 1812 | 2220 | 2225 | 3640 |
|--------------|--------|--------|-------|-------|-------|-------|-------|-------|
| Min Cap | 100pF | 150pF | 220pF | 220pF | 470pF | 1nF | 1nF | 2.2nF |
| 250V | 12nF | 39nF | 82nF | 82nF | 220nF | 680nF | 1µF | 1.8µF |
| 500V | 2.2nF | 6.8nF | 15nF | 15nF | 56nF | 150nF | 220nF | 560nF |
| 630V | 1.5nF | 4.7nF | 8.2nF | 8.2nF | 39nF | 100nF | 120nF | 470nF |
| 1000V | 390pF | 1.5nF | 2.7nF | 2.7nF | 15nF | 39nF | 56nF | 180nF |
| 1200V | - | 1nF | 2.2nF | 2.2nF | 10nF | 27nF | 39nF | 120nF |
| 1500V | - | 560pF | 1.2nF | 1.2nF | 5.6nF | 15nF | 22nF | 68nF |
| 2000V | - | 270pF | 560pF | 560pF | 3.3nF | 10nF | 12nF | 39nF |
| 2500V | - | - | - | - | 1.8nF | 5.6nF | 8.2nF | 22nF |
| 3000V | - | - | - | - | - | 3.9nF | 5.6nF | 12nF |
| 7" reel qty | 3,000 | 2,500 | 2,000 | 500 | 500 | 500 | 500 | n/a |
| 13" reel qty | 12,000 | 10,000 | 8,000 | 2,000 | 2,000 | 2,000 | 2,000 | 500 |

Note: Other capacitance values may become available, please contact the Sales Office if you need values other than those shown in the above table. For dimensions and soldering information, please go to our website www.knowlescapacitors.com

High Temp. HiT range - 200°C - COG/NP0 (1B) & X7R (2R1)

The HiT range of multilayer ceramic capacitors is suitable for a variety of high temperature applications including: oil exploration, geothermal, military, automotive under-hood and avionics.

This range is manufactured to exacting standards using our unique screen printing process. This provides a high quality component suitable for demanding applications.

- 200°C operating temperature
- 0603 to 2220 chip sizes
- COG/NP0 (1B) and X7R dielectric options
- Capacitance range COG/NP0 (1B) from 4.7pF up to 47nF
- Capacitance range X7R (2R1) from 100pF up to 4.7µF
- Voltage ratings from 10V to 630V
- RoHS compliant / Pb Free
- Sn over Ni termination
- Sample kits available

Insulation Resistance (IR)

25°C >100GΩ or 1000secs (whichever is the less).
200°C >1GΩ or 10secs (whichever is the less).

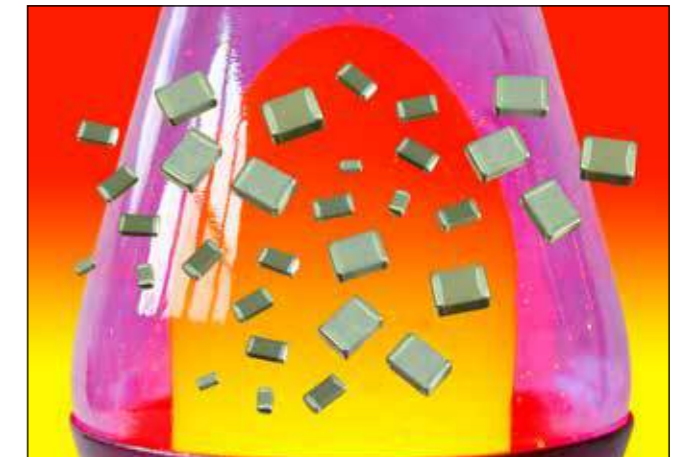

Temperature Coefficient of Capacitance (TCC)

COG/NP0 (1B) 30ppm/°C to +125°C.

X7R (2R1) ±15% to +125°C

Ageing Rate

COG/NP0 (1B) Zero.

X7R (2R1) typically less than 2% per time decade.

High Temp. HiT250 range - 250°C - COG/NP0 (1B) & X7R (2R1)

The HiT250 range of multilayer ceramic capacitors is suitable for a variety of high temperature applications including: oil exploration, geothermal, military, automotive under-hood and avionics.

This range is manufactured to exacting standards using our unique screen printing process. This provides a high quality component suitable for demanding applications.

- 250°C operating temperature
- 0603 to 2220 chip sizes
- COG/NP0 (1B) and X7R dielectric options
- Capacitance range COG/NP0 (1B) from 3.9pF up to 39nF
- Capacitance range X7R (2R1) from 1nF up to 2.2µF
- Voltage ratings from 10V to 630V
- RoHS compliant / Pb Free
- Sn over Ni termination
- Sample kits available



Insulation Resistance (IR)

25°C >100GΩ or 1000secs (whichever is the less).

250°C >100MΩ or 1secs (whichever is the less).

Temperature Coefficient of Capacitance (TCC)

COG/NP0 (1B) 30ppm/°C to +125°C

X7R (2R1) ±15% to +125°C

Ageing Rate

COG/NP0 (1B) Zero.

X7R (2R1) typically less than 2% per time decade.

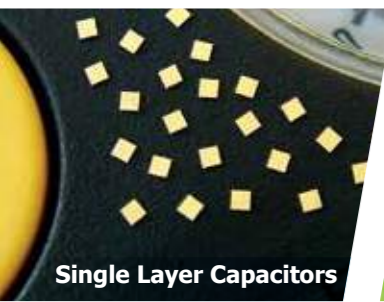

Single Layer Capacitors



Pulse Capacitors



StackiCap™ Capacitors



Hi-Rel Products

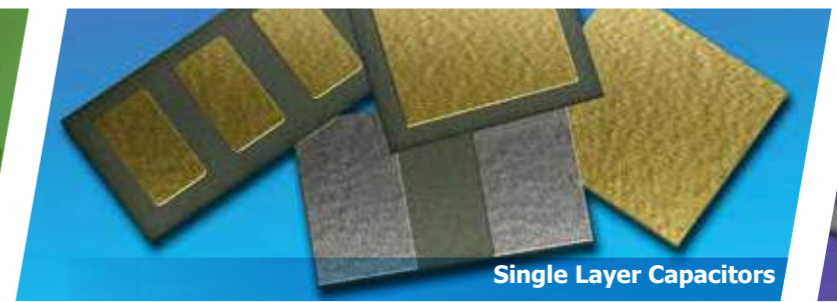

Single Layer Capacitors

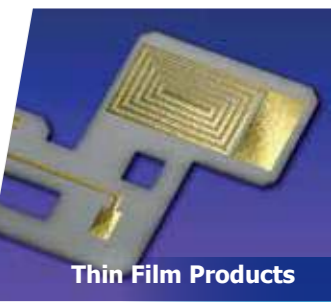

Thin Film Products

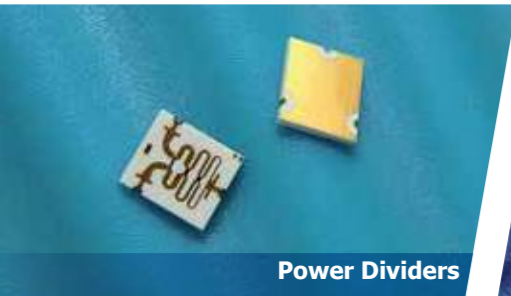

Power Dividers

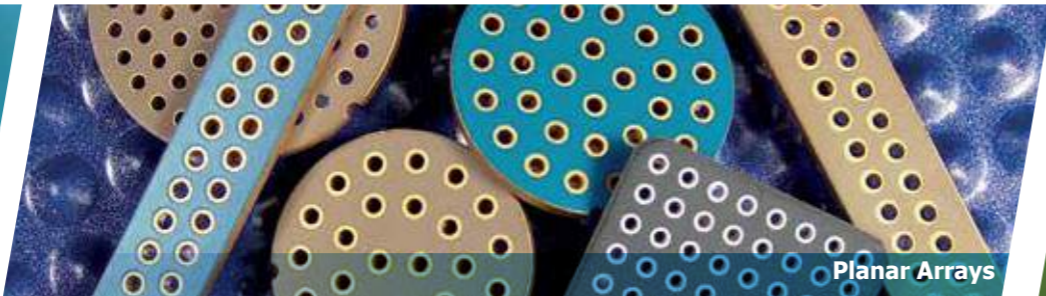

Planar Arrays



Ultra Low ESR Capacitors

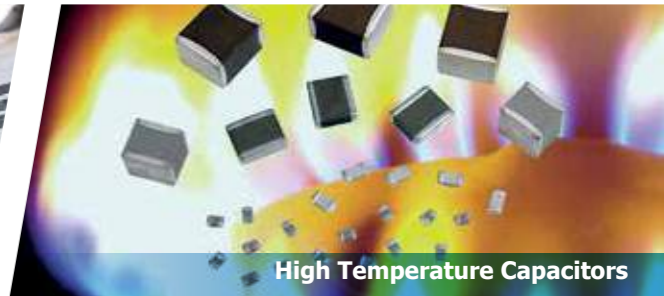

High Temperature Capacitors



Broadband Blocking Capacitors

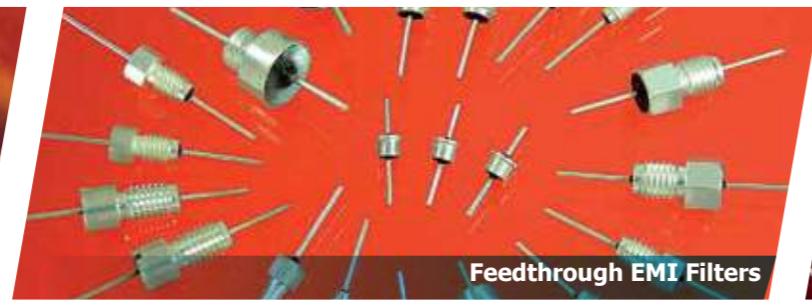

Feedthrough EMI Filters

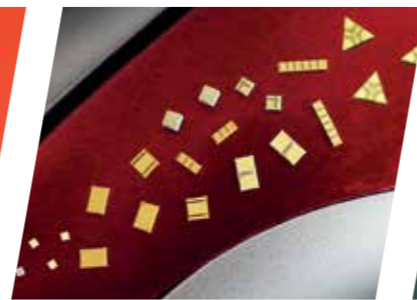

Opti-Cap Capacitors

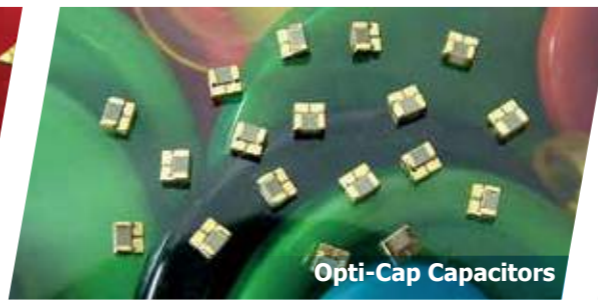

Safety Certified Capacitors



EMI Filters

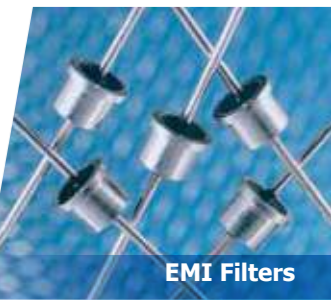

Gain Equalizers



Specialty Products



HIT Capacitors

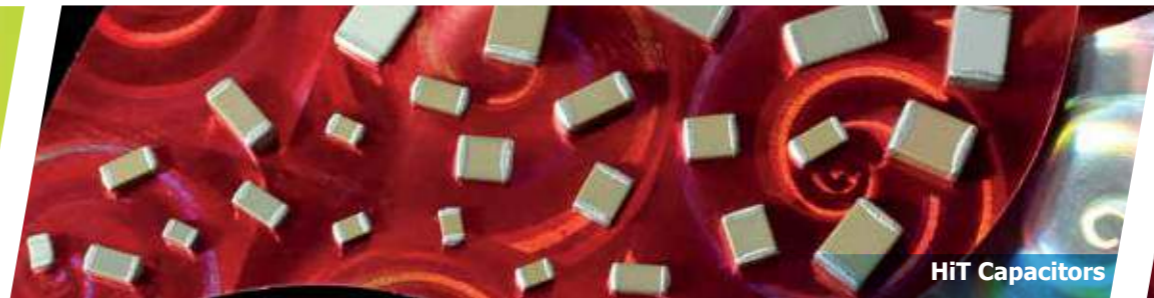

X2Y 3 terminal EMI chips



Solder in EMI Filters

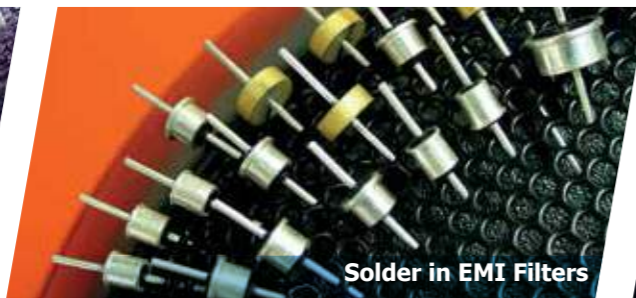

Pulse Power Capacitors



Radial Leaded Capacitors



High capacitance value chips

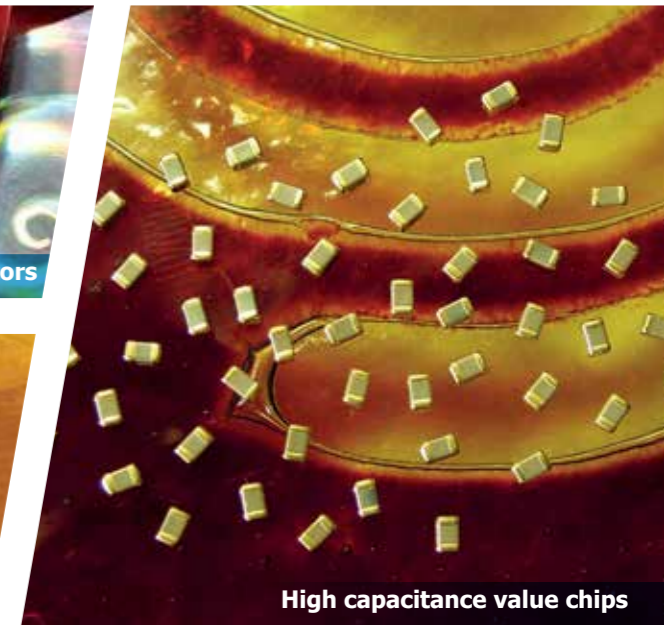

Other products available from





PRECISION DEVICES
knowles

**COMPEX • DLI • JOHANSON MFG
NOVACAP • SYFER • VOLTRONICS**

Asian Sales Office

O: +86 512 62588258

F: +86 512 62589258

KPD-Asia-sales@knowles.com

European Sales Office

O: +44 1603 723300

F: +44 1603 723301

KPD-Europe-sales@knowles.com

North American Sales Office

O: +1 661 295 5920

F: +1 661 295 5928

O: +1 315 655 8710

F: +1 315 655 0445

KPD-NA-sales@knowles.com

11069/Automotive/20/v2

X-ON Electronics

Largest Supplier of Electrical and Electronic Components

Click to view similar products for [Multilayer Ceramic Capacitors MLCC - SMD/SMT](#) category:

Click to view products by [Knowles](#) manufacturer:

Other Similar products are found below :

[M39014/02-1225V](#) [M39014/22-0631](#) [D55342E07B523DR-T/R](#) [NCA1206X7R103K50TRPF](#) [NCA1206X7R104K16TRPF](#) [NIN-FC2R7JTRF](#)
[NMC0402NPO220J50TRPF](#) [NMC0402X5R105K6.3TRPF](#) [NMC0402X5R224K6.3TRPF](#) [NMC0402X7R103J25TRPF](#)
[NMC0402X7R392K50TRPF](#) [NMC0603NPO201J50TRPF](#) [NMC0603X5R475M6.3TRPF](#) [NMC0603X7R333K16TRPF](#)
[NMC0805NPO820J50TRPF](#) [NMC0805X7R224K16TRPLPF](#) [NMC1206X7R102K50TRPF](#) [NMC1206X7R106K10TRPLPF](#)
[NMC1206X7R475K10TRPLPF](#) [C1608C0G2A221J](#) [C1608X7R1E334K](#) [C2012C0G2A472J](#) [2220J2K00562KXT](#) [CDR33BX104AKUR](#)
[CDR33BX683AKUS](#) [CGA3E1X7R1C684K](#) [CL10C0R8BB8ANNC](#) [C1005X5R0G225M](#) [C2012X7R2E223K](#) [C3216C0G2J272J](#)
[D55342E07B35E7R-T/R](#) [NMC0402NPO150G50TRPF](#) [NMC0402NPO560F50TRPF](#) [NMC0402X7R562J25TRPF](#)
[NMC0603NPO102J25TRPF](#) [NMC1206X7R332K50TRPF](#) [726632-1](#) [CGA6M3X7R1H225K](#) [CGA5L2X7R2A105K](#) [CGA3E2X8R1H223K](#)
[CDR33BX823AKUR\M500](#) [CDR35BX474AKUR\M500](#) [CDR35BX104BKUR\M500](#) [69995D](#) [NMC0201X5R473K6.3TRPF](#)
[NMC0201X7R221K25TRPF](#) [NMC0402X5R105K10TRPF](#) [NMC0402X5R224K10TRPF](#) [NMC0603X7R104J25TRPF](#)
[NMC0603X7R223K25TRPF](#)